

Device Modeling Report

COMPONENTS: DC MOTOR
PART NUMBER: RE-140
MANUFACTURER: MABUCHI MOTOR



Bee Technologies Inc.

Theory: Auto Balancing Bridge Method

Optimization of Simulation

Range of adjustment Frequency:40 to10K(Hz)

Frequency vs. $|Z|$ and Frequency vs. θz Characteristic

Attention)

Please use SPICE MODEL within the range from 40 to 10K(Hz) for best accuracy.

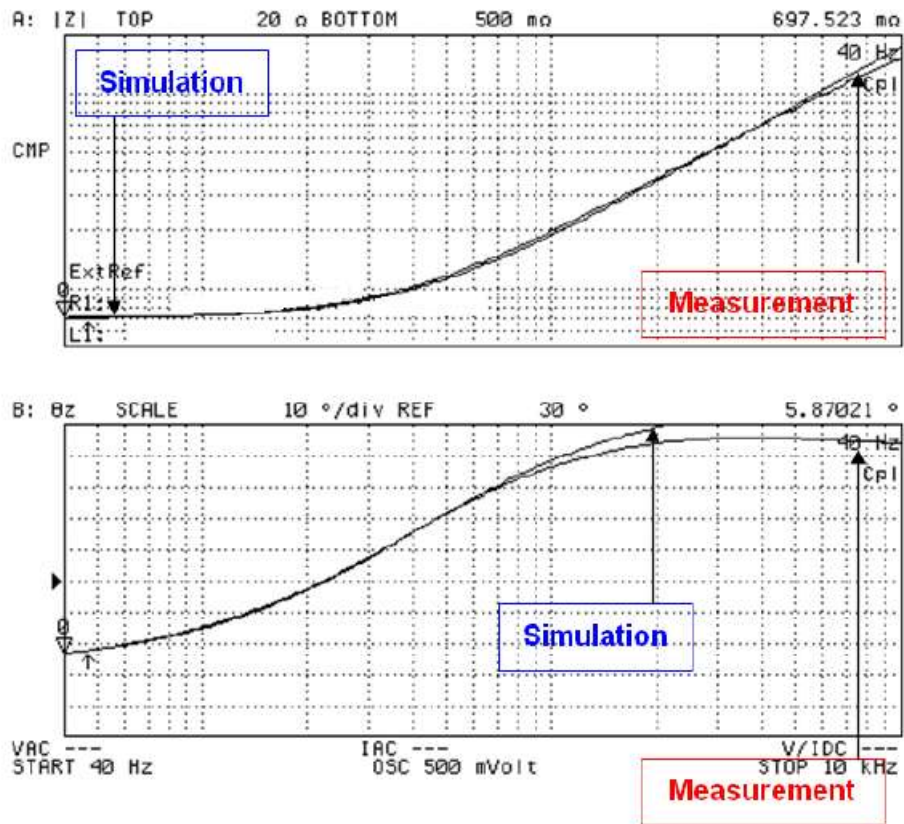

LM	
RS	
CP	

DC Motor Voltage and Current Characteristics at Noload

Circuit simulation result

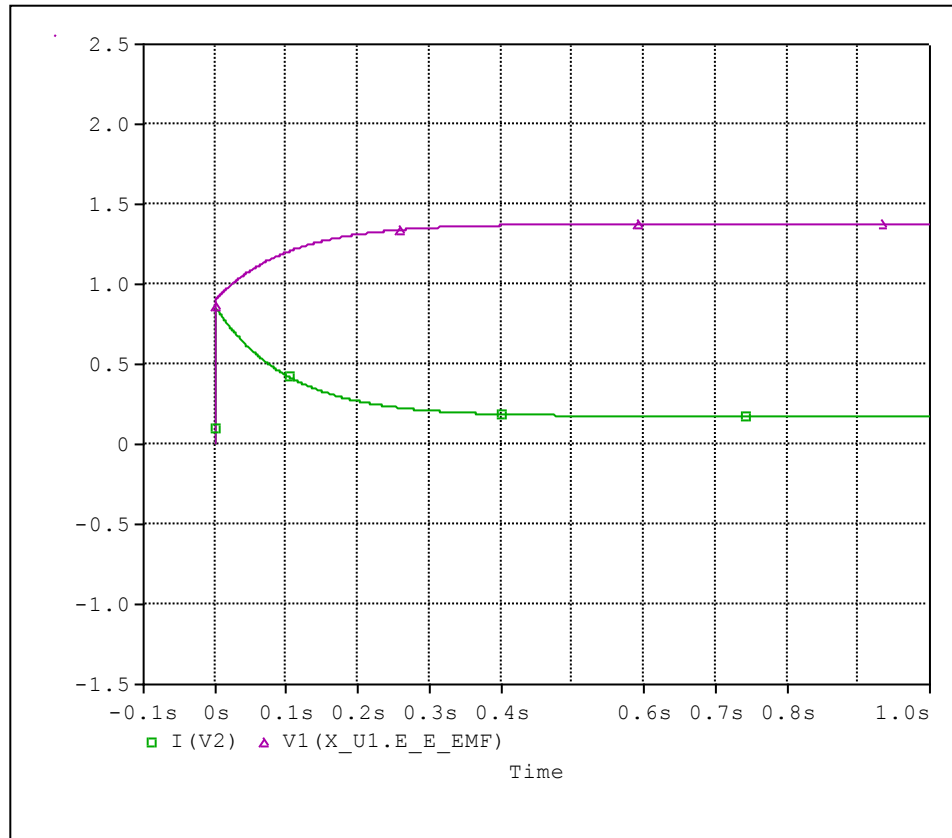

Evaluation circuit

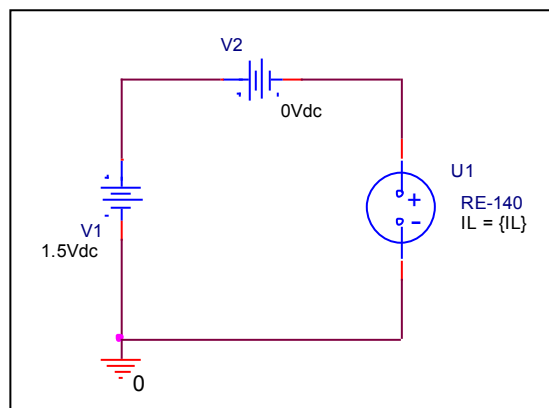

DC Motor Voltage and Current Characteristics (No load) Reference

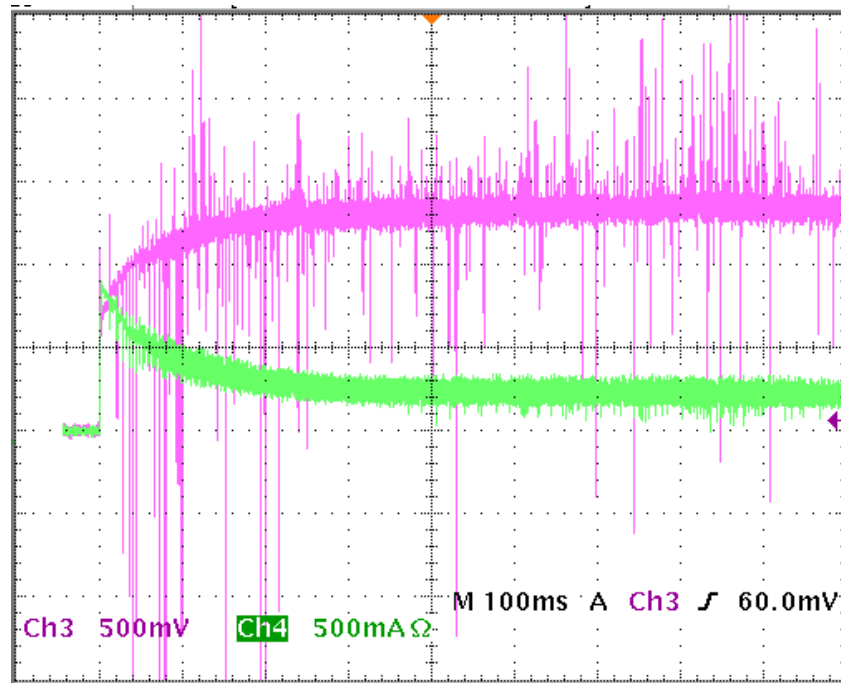

DC Motor Voltage and Current Characteristics at Fan load

Circuit simulation result

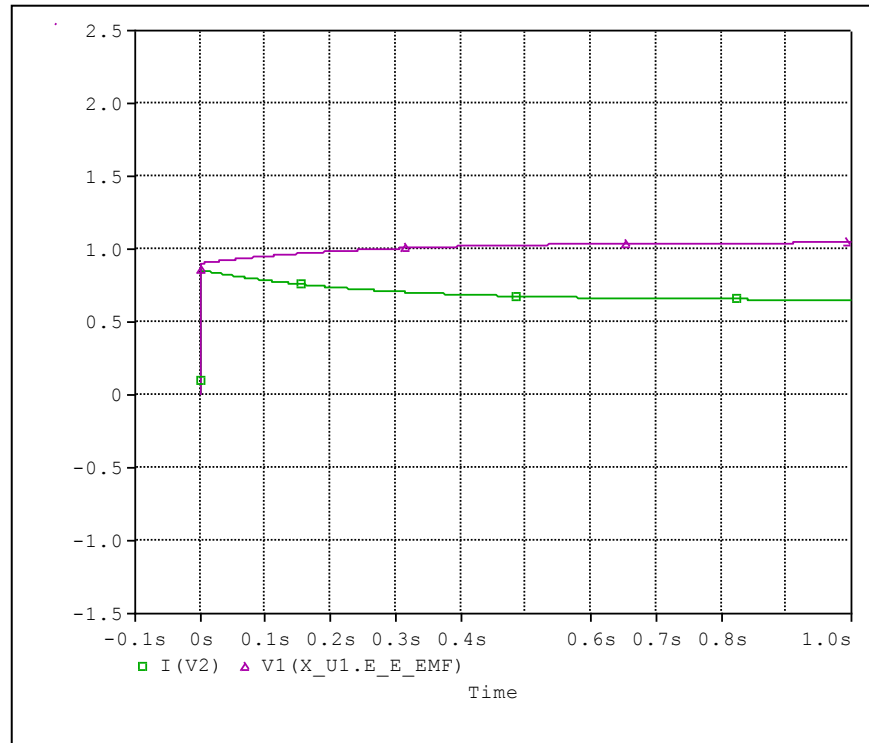

Evaluation circuit

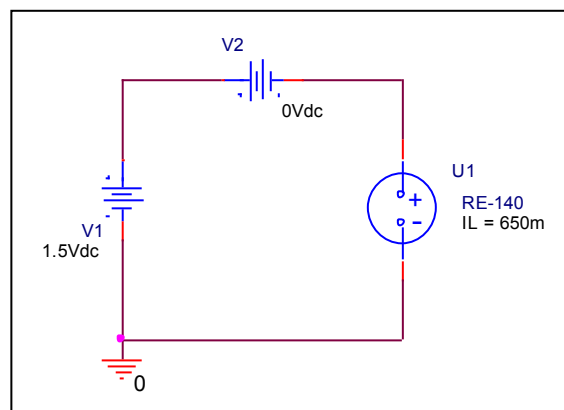

DC Motor Voltage and Current Characteristics (Fan load) Reference

