

Device Modeling Report

COMPONENTS: Filament Lamp
PART NUMBER: SLX60W240VES
MANUFACTURER: PT. Philips Indonesia



Bee Technologies Inc.

Transient Current Characteristics

Circuit simulation result

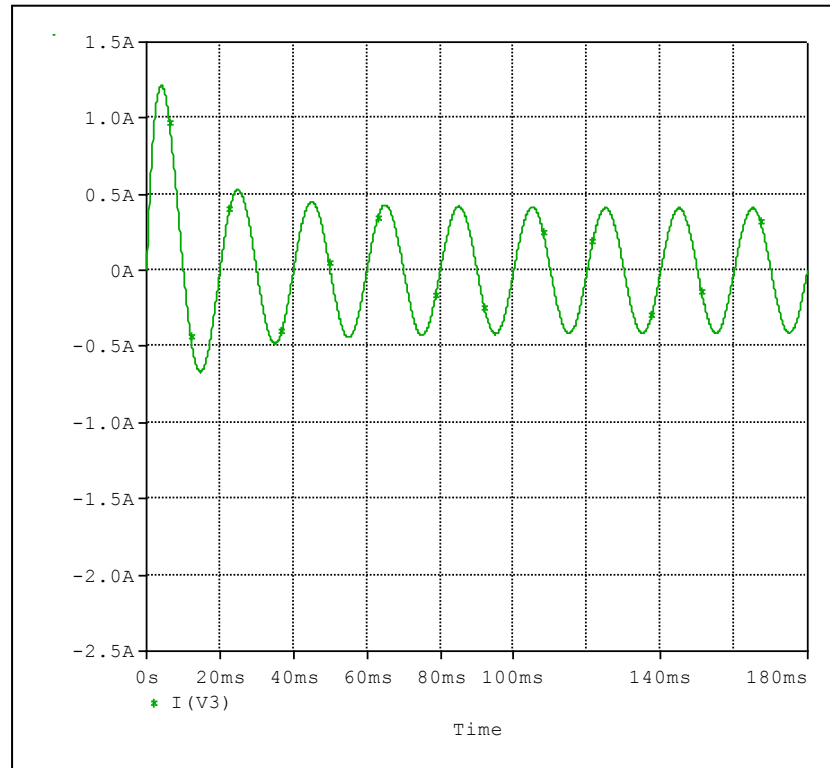

Evaluation circuit

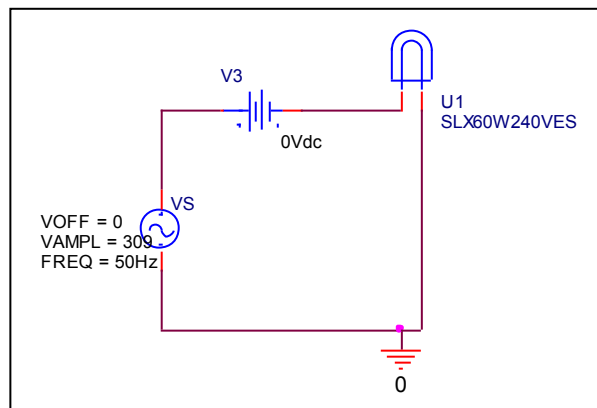

Transient Current Characteristics

Reference

