

Device Modeling Report

COMPONENTS:MAGNETIC CORE
PART NUMBER:3C34
MANUFACTURER:FERROXCUBE



Bee Technologies Inc.

MAGNETIC CORE

Pspice model parameter	Model description
A	thermal energy parameter
K	domain anisotropy parameter
C	domain flexing parameter
MS	magnetization saturation

Hysteresis Curve Characteristics

Evaluation Circuit

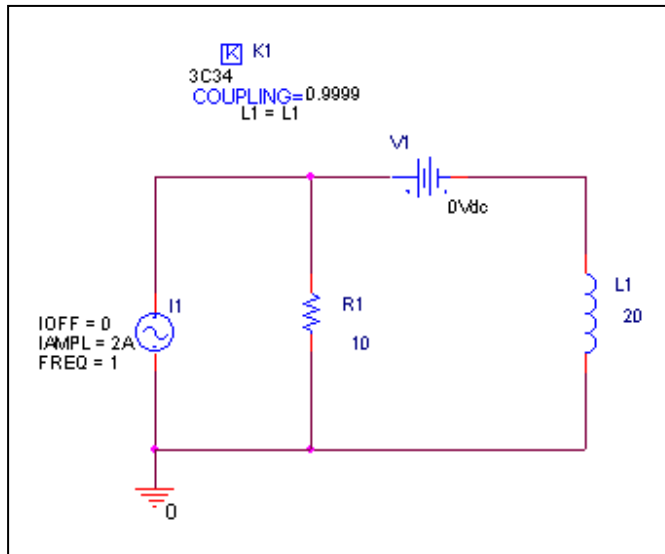

Simulation result

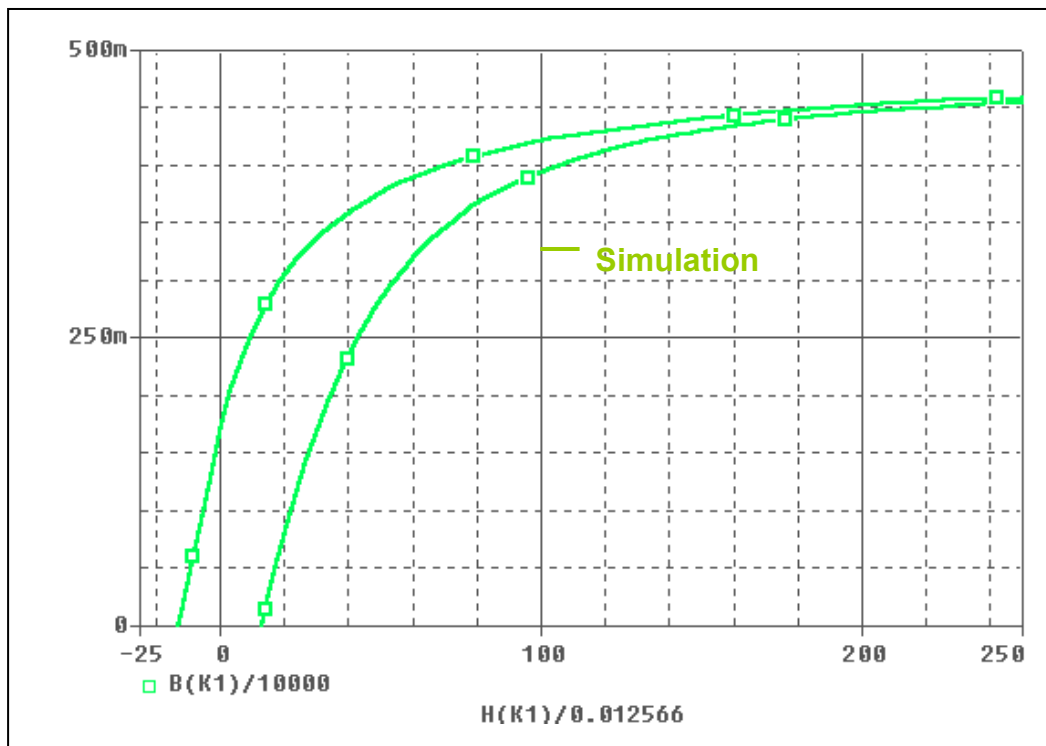

Simulation result

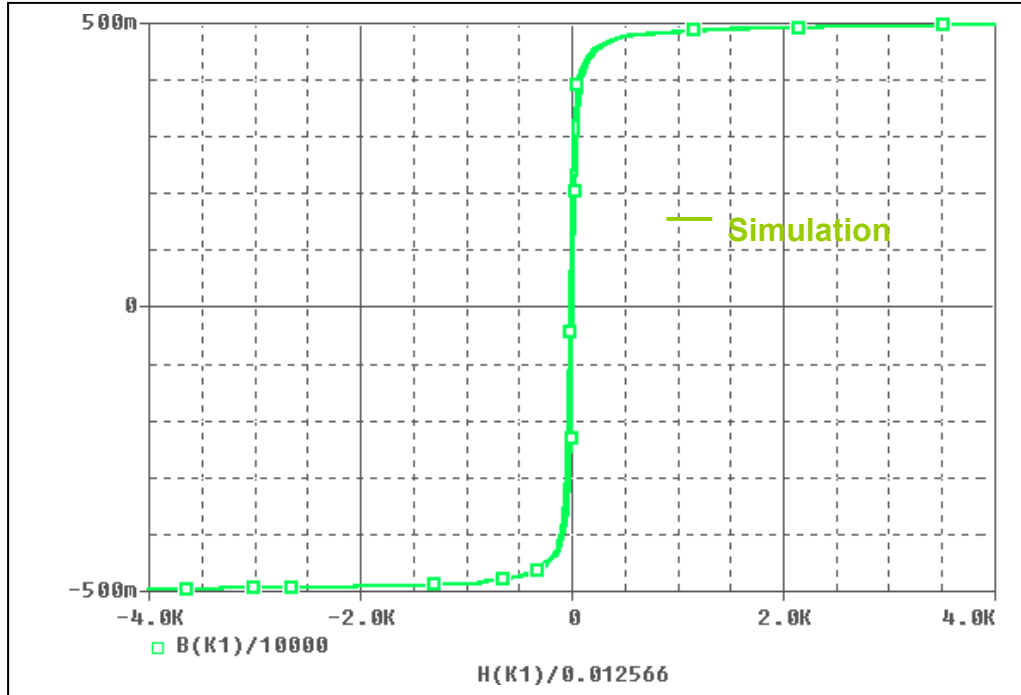

Comparison Table

H(A/m)	B(mT) Measurement	B(mT) Simulation	%Error
0	160	165.079	3.174
50	380	375.578	1.164
75	415	403.867	2.683
100	425	421.246	0.883
125	440	430.977	2.051
150	446	440.597	1.211
175	449	446.993	0.447
200	450	452.112	0.469
250	450	458.192	1.820
20	75	77.778	3.704
50	275	284.127	3.319
100	405	394.489	2.595
125	423	415.793	1.704
150	435	429.463	1.273
175	446	438.814	1.611
200	450	445.835	0.926
250	450	455.468	1.215