

Device Modeling Report

COMPONENTS:MAGNETIC CORE
PART NUMBER:3S3
MANUFACTURER:FERROXCUBE



Bee Technologies Inc.

MAGNETIC CORE

Pspice model parameter	Model description
A	thermal energy parameter
K	domain anisotropy parameter
C	domain flexing parameter
MS	magnetization saturation

Hysteresis Curve Characteristics

Evaluation Circuit

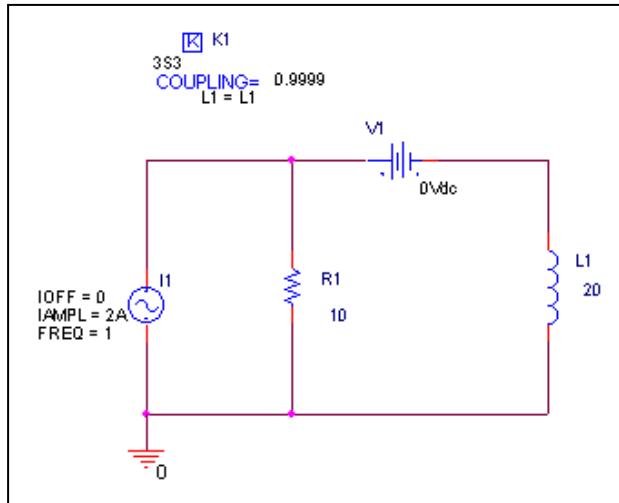

Simulation result

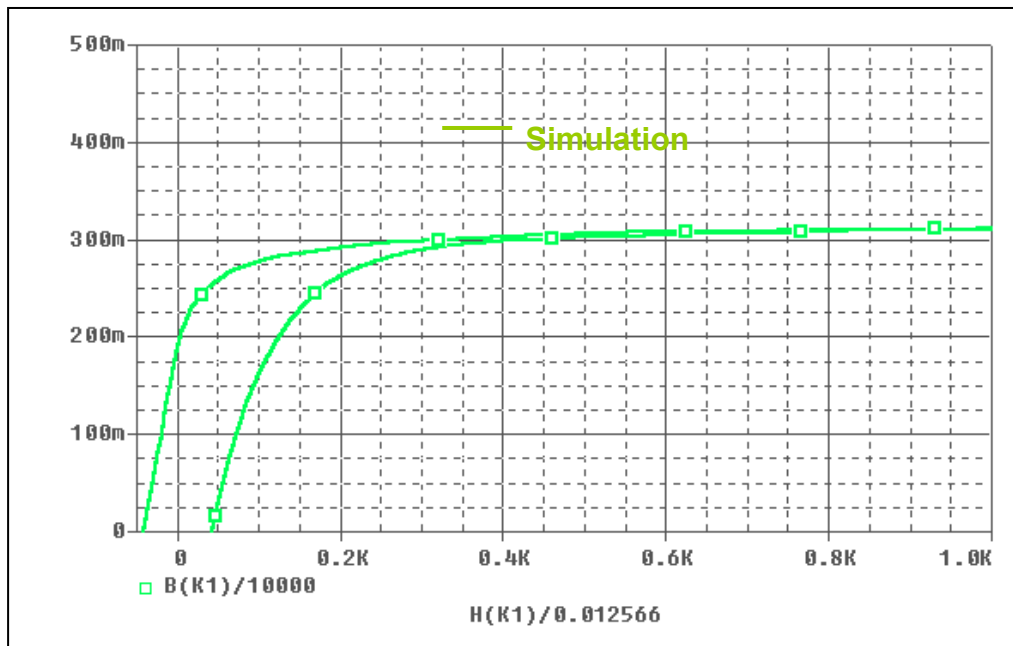

Simulation result

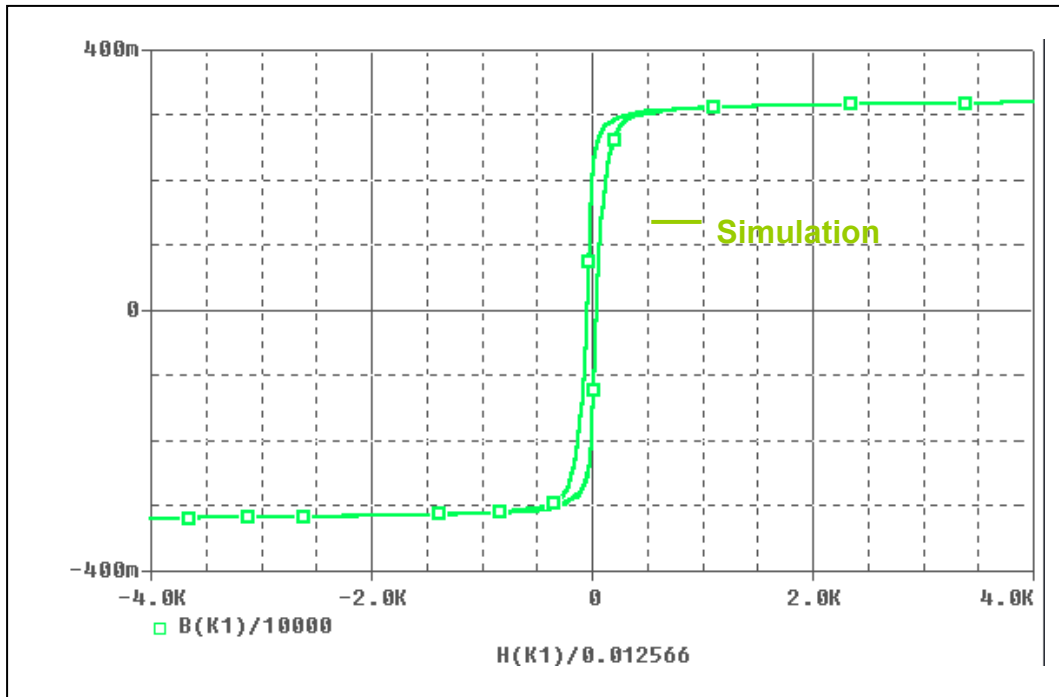

Comparison Table

H(A/m)	B(mT) Measurement	B(mT) Simulation	%Error
50	260	258.726	0.490
100	280	277.405	0.927
180	292	289.779	0.761
260	298	297.165	0.280
340	300	300.115	0.038
420	305	303.065	0.634
500	308	305.783	0.720
600	310	307.23	0.894
800	310	309.767	0.075
1000	310	311.388	0.448
260	283	281.842	0.409
340	290	293.872	1.335
420	298	299.576	0.529
500	300	302.88	0.960
600	310	305.583	1.425
800	310	308.759	0.400
1000	310	310.748	0.241