

Device Modeling Report

COMPONENTS: TRANSISTOR
PART NUMBER: 2SA1532
MANUFACTURER: PANASONIC



Bee Technologies Inc.

TRANSISTOR MODEL

PSpice model parameter	Model description
IS	Saturation Current
BF	Ideal Maximum Forward Beta
NF	Forward Current Emission Coefficient
VAF	Forward Early Voltage
IKF	Forward Beta Roll-off Knee Current
ISE	Non-ideal Base-Emitter Diode Saturation Current
NE	Non-ideal Base-Emitter Diode Emission Coefficient
BR	Ideal Maximum Reverse Beta
NR	Reverse Emission Coefficient
VAR	Reverse Early Voltage
IKR	Reverse Beta Roll-off Knee Current
ISC	Non-ideal Base-Collector Diode Saturation Current
NC	Non-ideal Base-Collector Diode Emission Coefficient
NK	Forward Beta Roll-off Slope Exponent
RE	Emitter Resistance
RB	Base Resistance
RC	Series Collector Resistance
CJE	Zero-bias Emitter-Base Junction Capacitance
VJE	Emitter-Base Junction Potential
MJE	Emitter-Base Junction Grading Coefficient
CJC	Zero-bias Collector-Base Junction Capacitance
VJC	Collector-base Junction Potential
MJC	Collector-base Junction Grading Coefficient
FC	Coefficient for Onset of Forward-bias Depletion Capacitance
TF	Forward Transit Time
XTF	Coefficient for TF Dependency on Vce
VTF	Voltage for TF Dependency on Vce
ITF	Current for TF Dependency on Ic
PTF	Excess Phase at $f=1/2\pi*TF$
TR	Reverse Transit Time
EG	Activation Energy
XTB	Forward Beta Temperature Coefficient
XTI	Temperature Coefficient for IS

Reverse

Reverse Early Voltage Characteristic

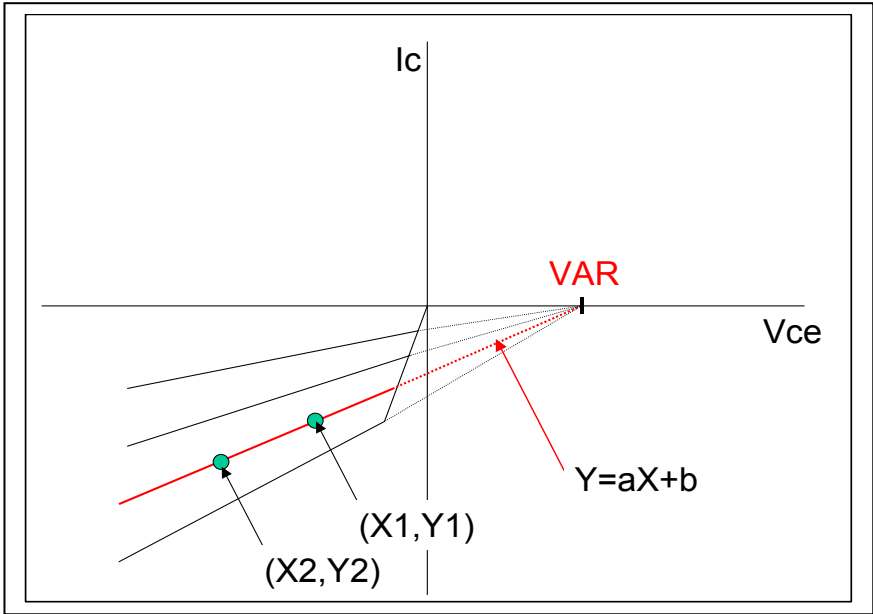
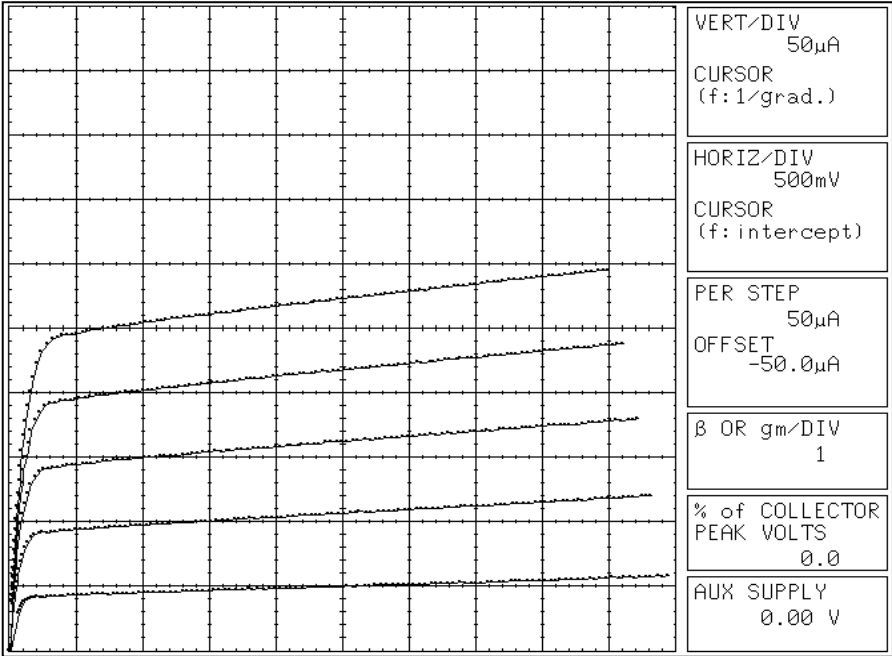

Reverse DC Beta Characteristic (Ie vs. hFE)

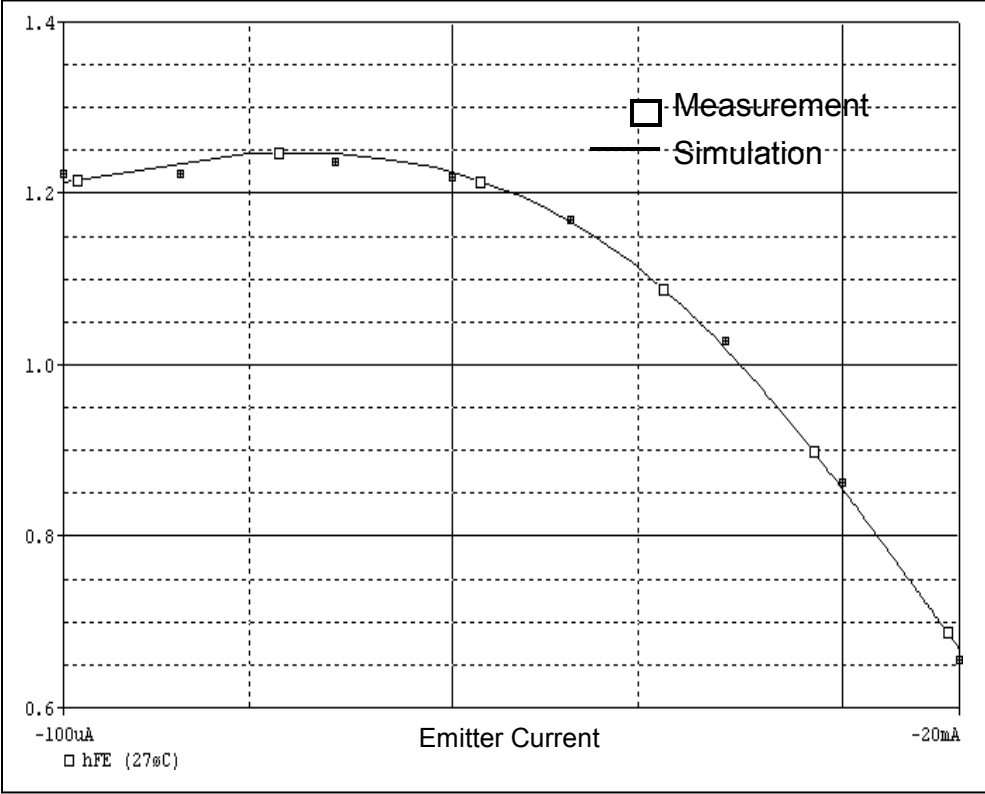

Forward

Forward Early Voltage Characteristic

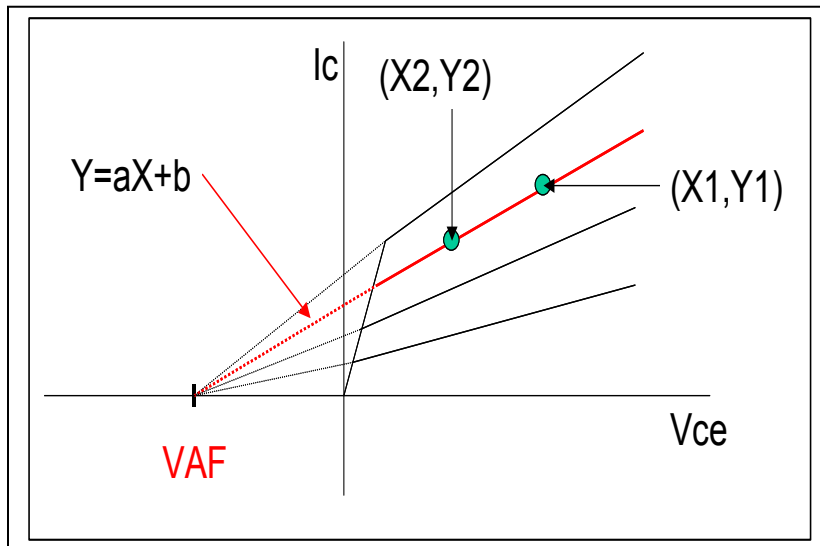
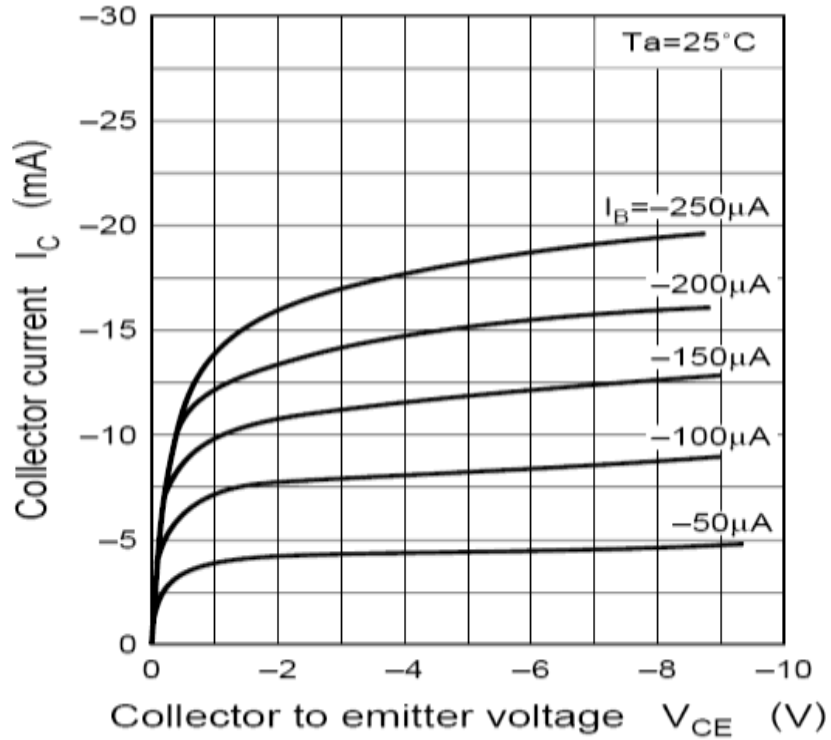

C-B Capacitance Characteristics

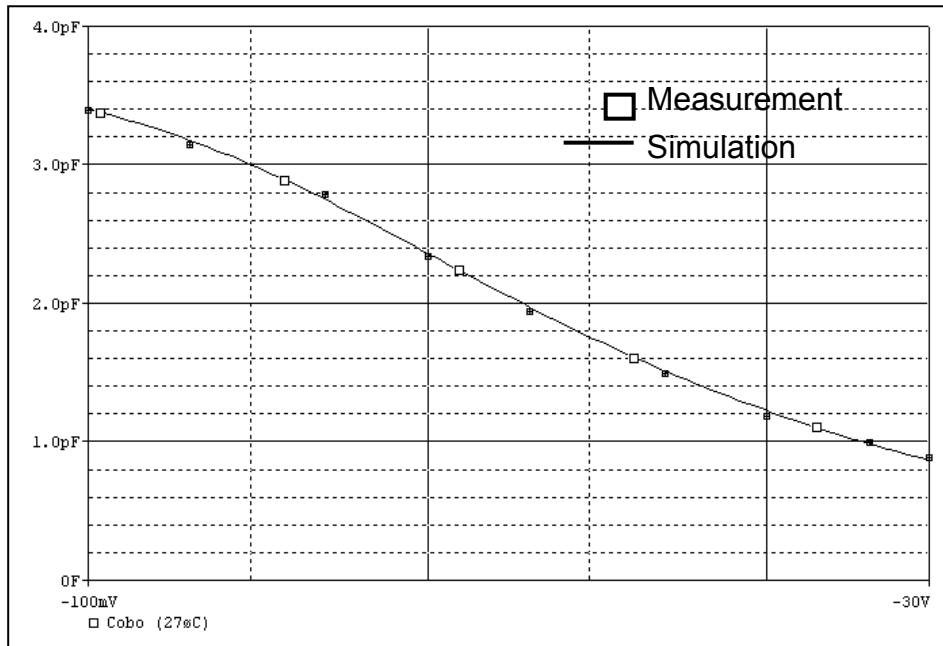

E-B Capacitance Characteristics

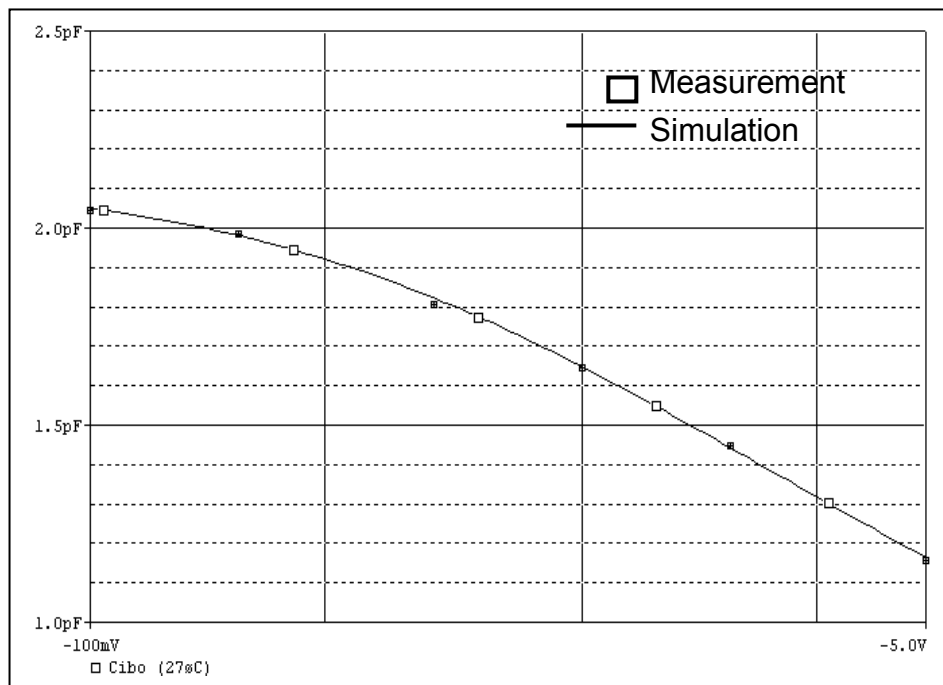

Transistor h_{FE} - I_C Characteristics

Circuit Simulation Result

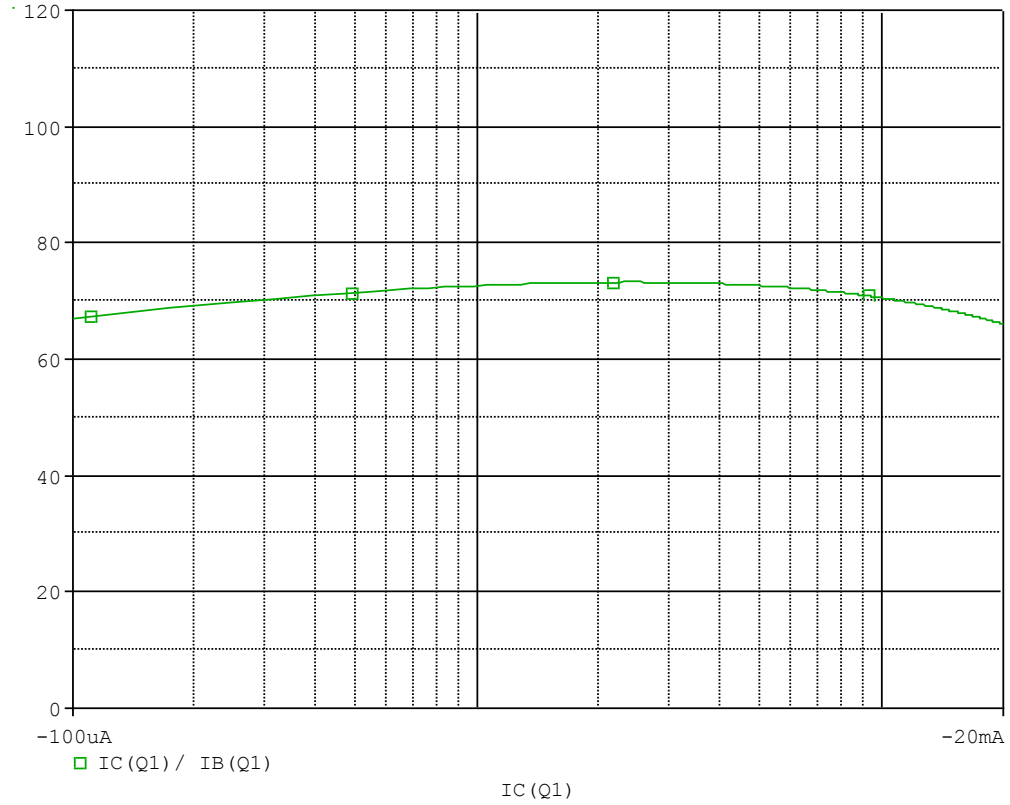

Evaluation Circuit

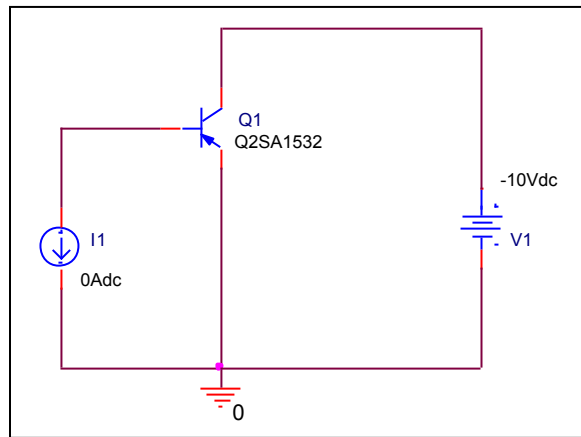

Comparison Graph

Circuit Simulation Result

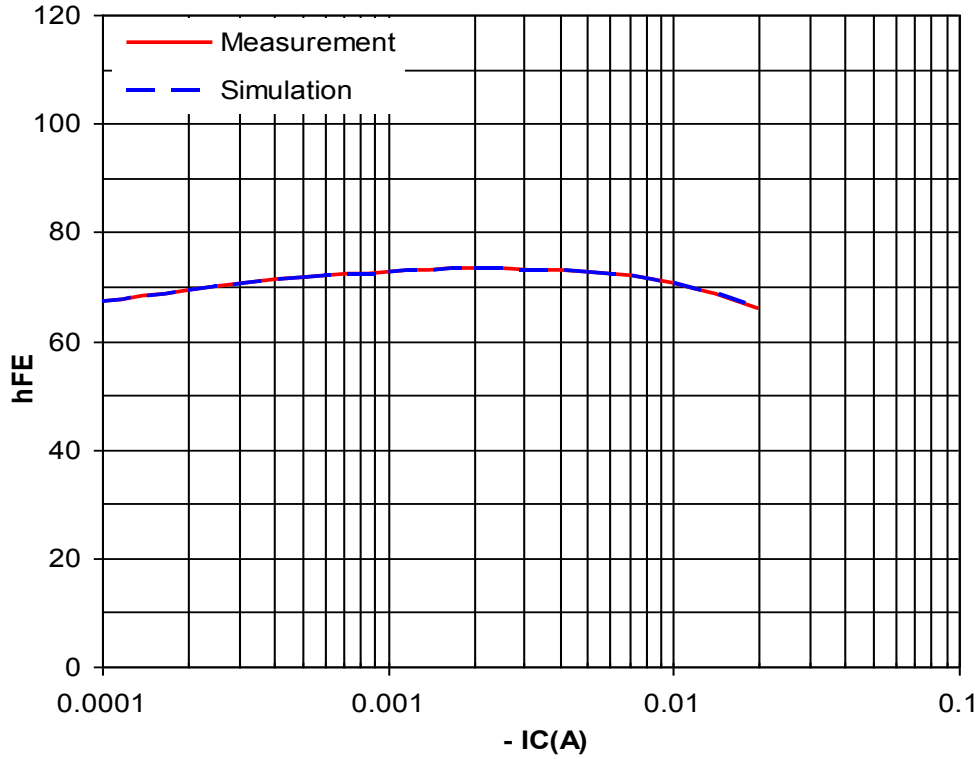

Simulation Result

Ic(A)	hFE		Error (%)
	Measurement	Simulation	
-0.0001	67.150	67.141	-0.013
-0.0002	69.300	69.294	-0.009
-0.0005	71.500	71.503	0.004
-0.001	72.600	72.651	0.070
-0.002	73.200	73.222	0.030
-0.005	72.600	72.645	0.062
-0.01	70.500	70.522	0.031
-0.02	66.000	66.045	0.068

$V_{CE(Sat)}$ - I_C Characteristics

Circuit Simulation Result

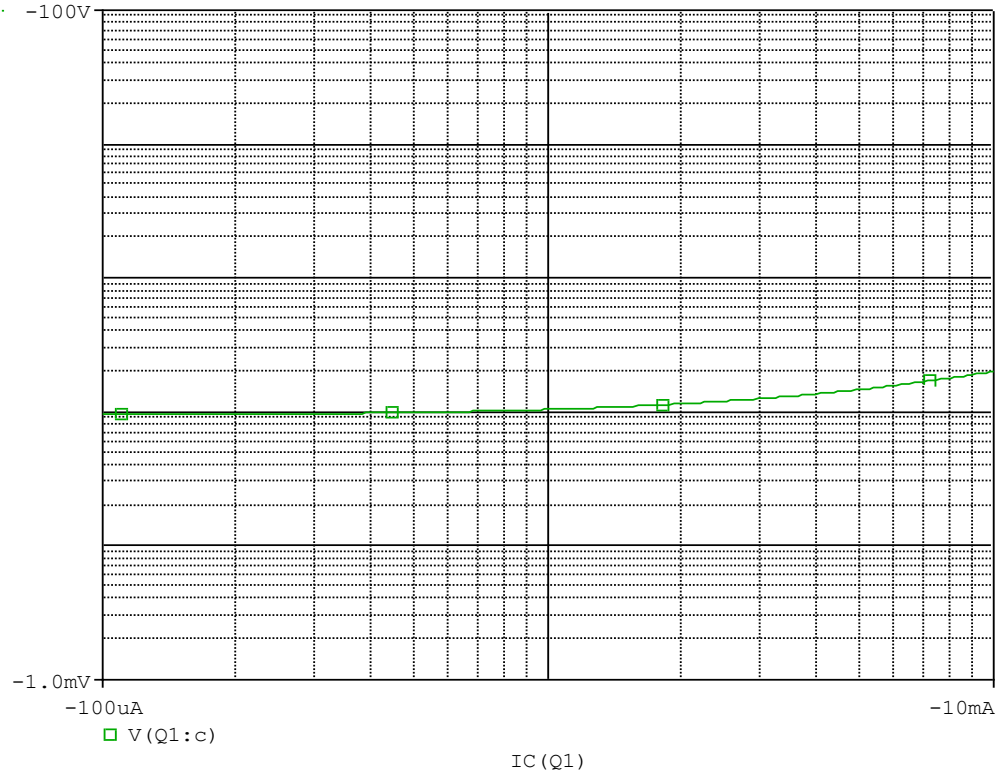

Evaluation Circuit

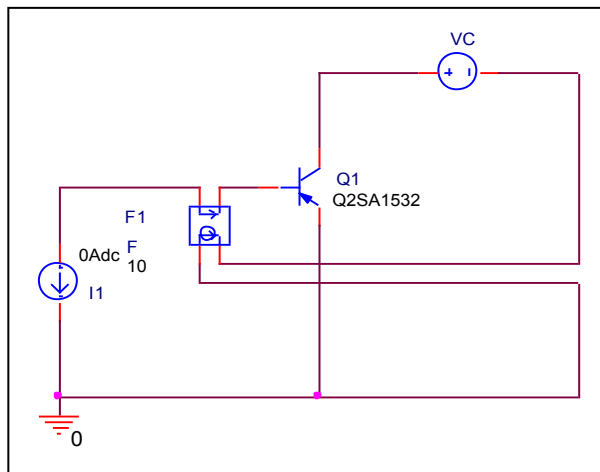

Comparison Graph

Circuit Simulation Result

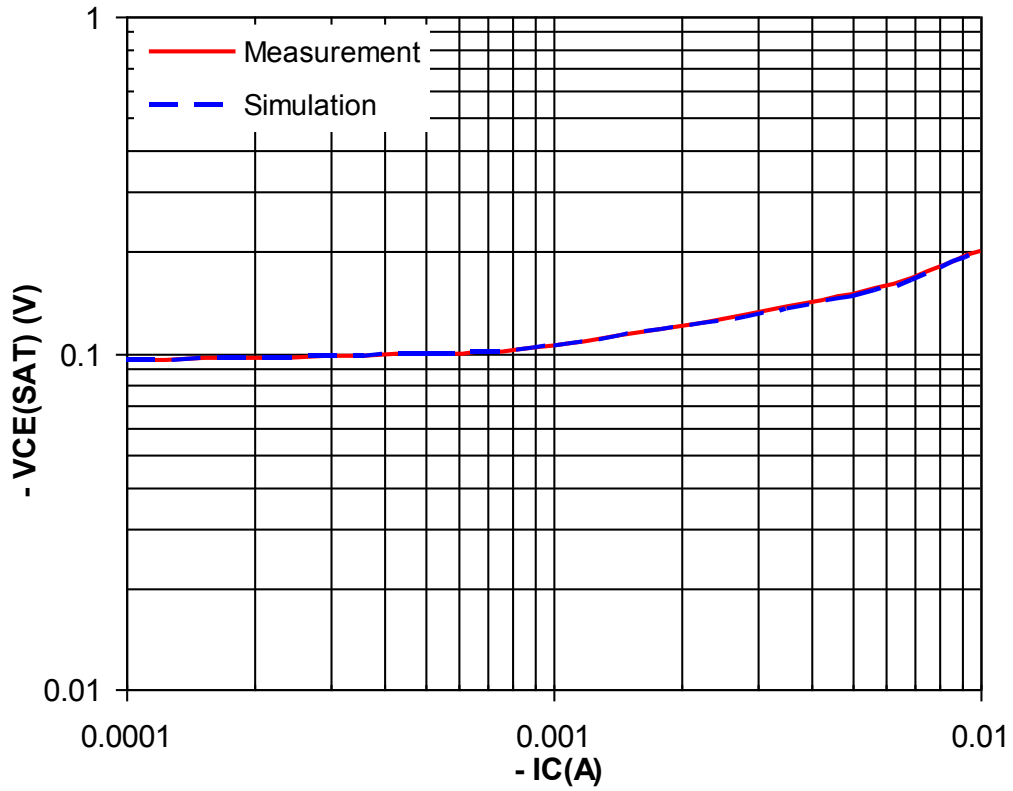

Simulation Result

IC(A)	VCE(sat)(V)		Error (%)
	Measurement	Simulation	
-0.0001	-9.50E-02	-9.52E-02	0.262
-0.0005	-9.90E-02	-9.91E-02	0.086
-0.001	-1.05E-01	-1.04E-01	-0.539
-0.005	-1.49E-01	-1.47E-01	-1.330
-0.01	-2.00E-01	-2.00E-01	0.095

Comparison Graph

Circuit Simulation Result

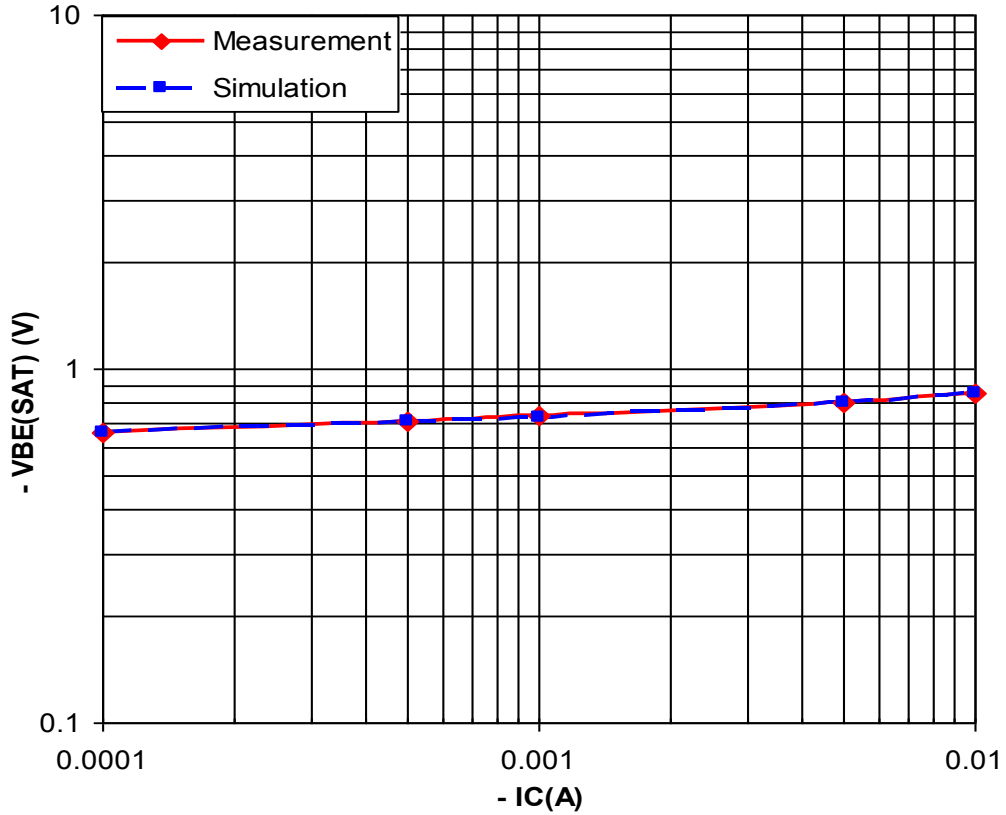

Simulation Result

IC(A)	VBE(sat)(V)		Error (%)
	Measurement	Simulation	
-0.0001	-0.664	-6.64E-01	0.664
-0.0005	-0.712	-7.09E-01	0.712
-0.001	-0.735	-7.30E-01	0.735
-0.005	-0.805	-8.02E-01	0.805
-0.01	-0.855	-8.58E-01	0.855

Output Characteristics

Circuit Simulation Result

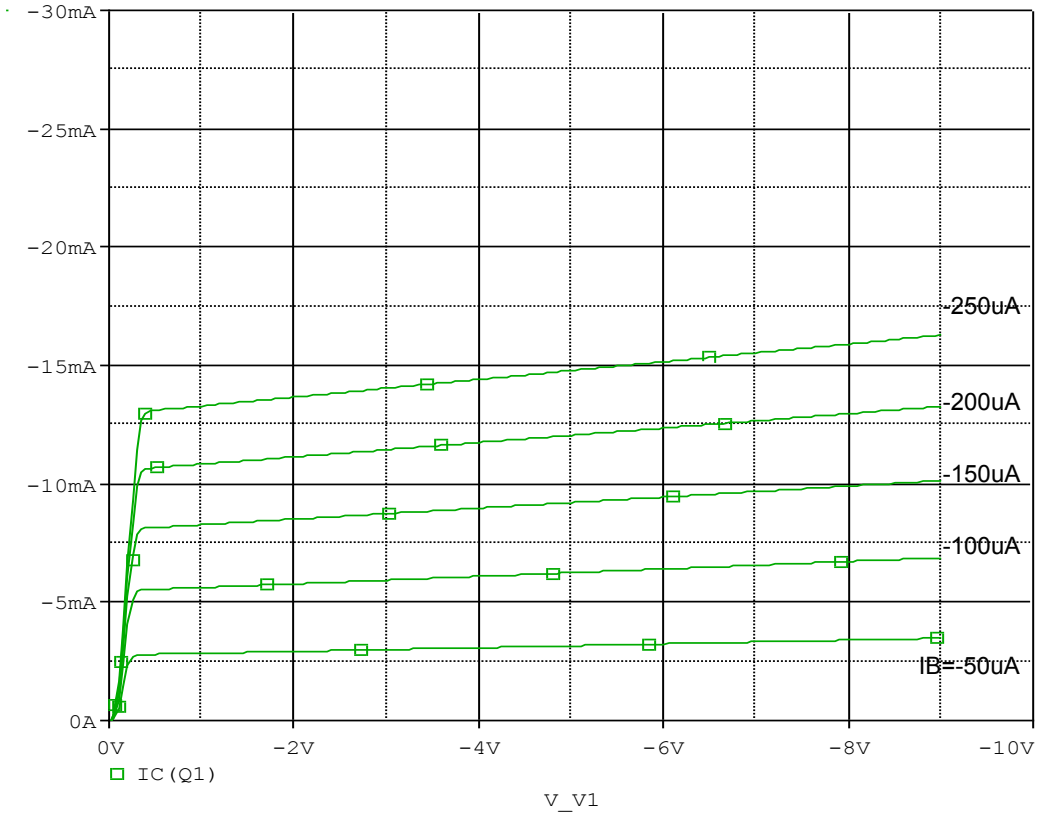

Evaluation Circuit

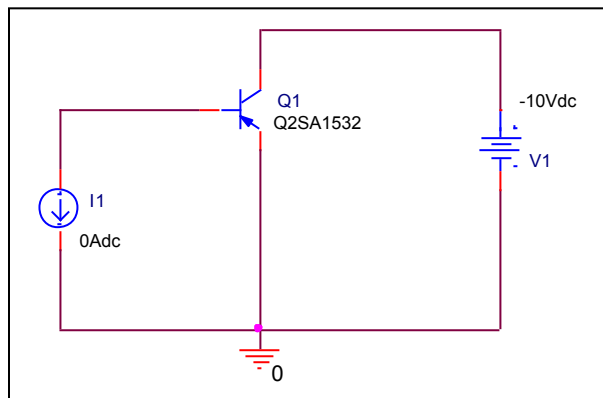

Output Characteristics

Reference

