

2015 RF Devices and High Frequency Inductors

Product catalog

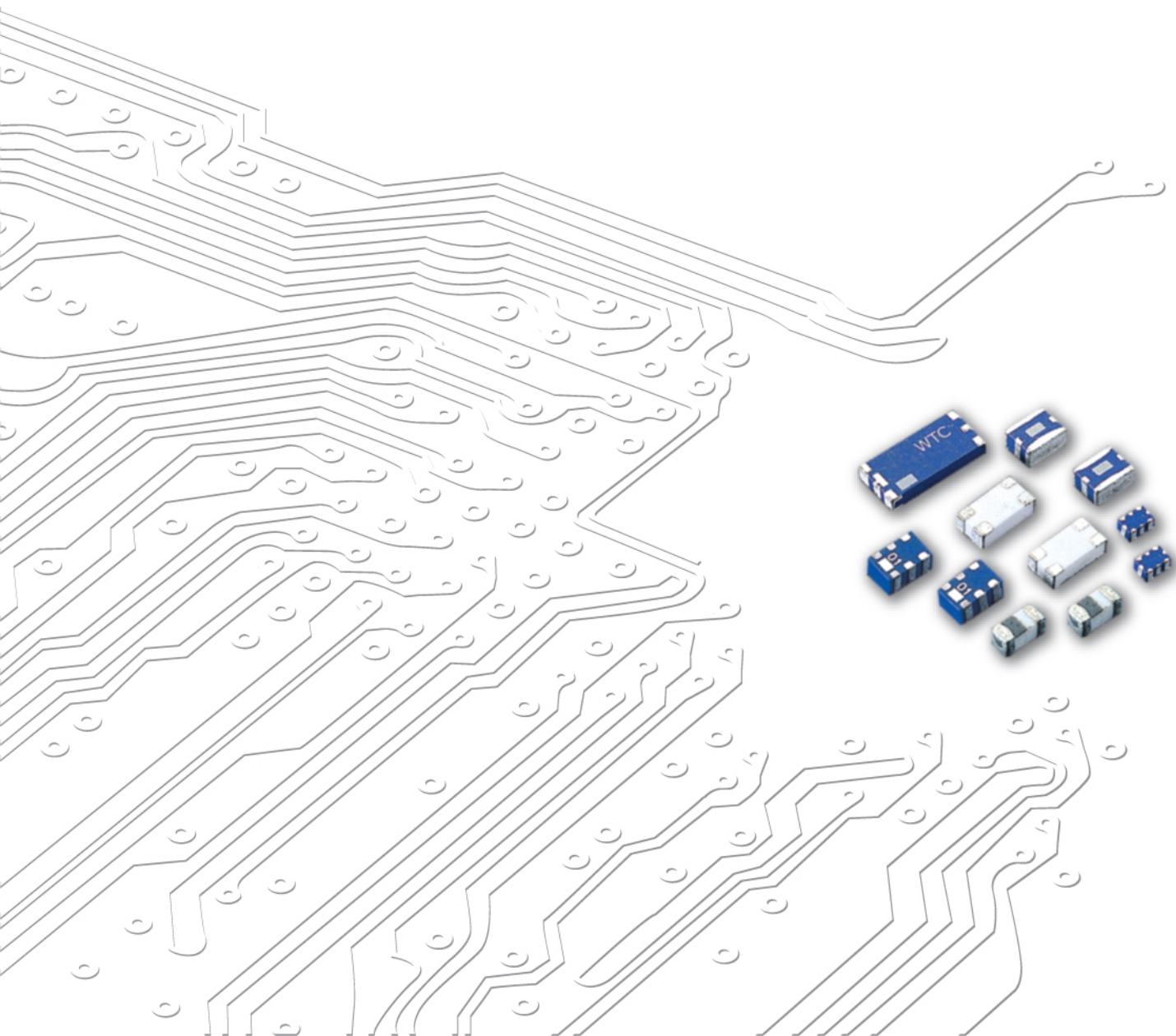

Product Portfolio

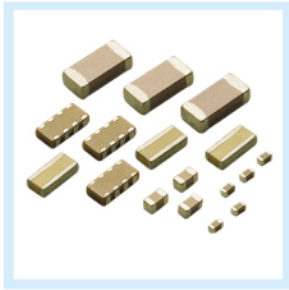

Multilayer Ceramic Capacitors (MLCC)

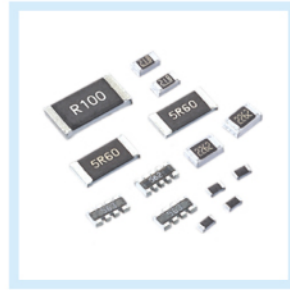

Chip-Resistor

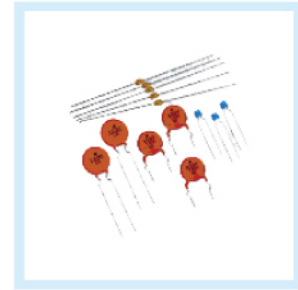

Disc Capacitors



RF Device and High Frequency Inductors



Inductors



Varistors and SMD-Varistors

IEC-63 Nominal Resistance / Capacitance

E1	100																							
E3	100			220			470																	
E6	100	150	220	330	470	680																		
E12	100	120	150	180	220	270	330	390	470	560	680	820												
E24	100	110	120	130	150	160	180	200	220	240	270	300	330	360	390	430	470	510	560	620	680	750	820	910
E96	100	102	121	124	147	150	178	182	215	221	261	267	316	324	383	392	464	475	562	576	681	698	825	845
	105	107	127	130	154	158	187	191	226	232	274	280	332	340	402	412	487	499	590	604	715	732	866	887
	110	113	133	137	162	165	196	200	237	243	287	294	348	357	422	432	511	523	619	634	750	768	909	931
	115	118	140	143	169	174	205	210	249	255	301	309	365	374	442	453	536	549	649	665	787	806	953	976

E6: $\sqrt[6]{10} \approx 1.46$ E12: $\sqrt[12]{10} \approx 1.21$

E1 series resistance: 1Ω, 10Ω, 100Ω, 1000Ω, 10000Ω, 100000Ω

INDEX

Subject	Page
ORDERING CODE	1~5
CHIP ANTENNA	6~12
<ul style="list-style-type: none"> ● 1.575GHz GPS BAND WORKING FREQUENCY ● Bluetooth/WiFi BAND WORKING FREQUENCY ● WiMAX BAND WORKING FREQUENCY 	
HIGH FREQUENCY MULTILAYER BAND PASS FILTER	13~24
<ul style="list-style-type: none"> ● DVB BAND WORKING FREQUENCY ● 1.8GHz BAND WORKING FREQUENCY ● 2.4GHz BAND WORKING FREQUENCY ● 1558 ~ 1606 MHz GNSS Band Applications ● 5GHz BAND WORKING FREQUENCY ● WiMAX BAND WORKING FREQUENCY 	
HIGH FREQUENCY MULTILAYER BALANCED FILTER	25~27
<ul style="list-style-type: none"> ● 2.4GHz BAND WORKING FREQUENCY 	
HIGH FREQUENCY MULTILAYER LOW PASS FILTER	28~34
<ul style="list-style-type: none"> ● GSM850/900GHz BAND WORKING FREQUENCY ● DCS/PCS BAND WORKING FREQUENCY ● TD-SCDMA BAND WORKING FREQUENCY ● 2.4GHz BAND WORKING FREQUENCY ● 5GHz BAND WORKING FREQUENCY ● LTE BAND APPLICATION 	
HIGH FREQUENCY MULTILAYER HIGH PASS FILTER	35
<ul style="list-style-type: none"> ● ISM 2.4/5GHz BAND APPLICATION 	
BALUN TRANSFORMERS	36~43
<ul style="list-style-type: none"> ● ISM Band 2.4GHz Application ● ISM Band 5GHz Application ● LTE Band Application ● GSM 850/ GSM 900/ DCS1800/ PCS1900 Application 	
DIPLEXER	44~50
<ul style="list-style-type: none"> ● ISM Band 2.4GHz Application ● GPS 1.575 GHz/ISM 2.4GHz Application ● 892 MHz & 1.94GHz Band Working Frequency 	
COMMON MODE FILTER	51~54
<ul style="list-style-type: none"> ● DISCRETE CMF ● ARRAY CMF 	
THIN FILM COMMON MODE FILTER	55~56
COUPLER	57~59
<ul style="list-style-type: none"> ● ISM Band 2.4GHz APPLICATION ● LTE BAND APPLICATION 	
EMI FILTER ARRAY	60
Dipole Antenna(N/SMA) (Cable)	61~71
<ul style="list-style-type: none"> ● Cable Assembly ● PCB Antenna ● FPA Antenna ● Metal Antenna ● NFC Antenna(NFC/WPC/WNC) ● Connector 	

*The specifications are subject to change or our products in it may be discontinued without advance notice. Please check with our sales representatives or product engineers before ordering.

*This catalog has only typical specifications because there is no space for detailed specifications. Therefore, please approve our product specifications or transact the approval sheet for product specification before ordering.

■ CHIP ANTENNA

RF	ANT	321612	0	A	5	T
<u>Type code</u>	<u>Product code</u>	<u>Dimension code</u>	<u>Unit of dimension</u>	<u>Application</u>	<u>Specification</u>	<u>Packing</u>
RF/RG: device	ANT : Antenna FRA : Free Antenna ECA : SMD Antenna	Per 2 digits of Length, Width, Thickness 321612 = Length =32 Width = 16 Thickness = 12	0 : 0.1 mm 1 : 1.0 mm	A : 2.4GHz ISM Band E : GPS 1.5GHz L : 2.4/5.2/5.8GHz Tri Band W : WiMAX	Code from 0~9 dependent on different electrical specification	T : 7" Reeled G:13" Reeled

■ HIGH FREQUENCY MULTILAYER BAND PASS FILTER

RF	BPF	322515	0	A	4	T
<u>Type code</u>	<u>Product code</u>	<u>Dimension code</u>	<u>Unit of dimension</u>	<u>Application</u>	<u>Specification</u>	<u>Packing</u>
RF device	BPF : Band Pass Filter	Per 2 digits of Length, Width, Thickness 322515 = Length =32 Width = 25 Thickness = 15	0 : 0.1 mm 1 : 1.0 mm	A : 2.4GHz ISM Band W : WiMAX K : ISM 5.2/5.8 Dual Band	Code from 0~9 dependent on different electrical specification	T : 7" Reeled G:13" Reeled

■ HIGH FREQUENCY MULTILAYER BALANCED FILTER

RF	BPB	252009	0	A	7	T
<u>Type code</u>	<u>Product code</u>	<u>Dimension code</u>	<u>Unit of dimension</u>	<u>Application</u>	<u>Specification</u>	<u>Packing</u>
RF/RG: device	BPB : Balanced Type Band Pass Filter	Per 2 digits of Length, Width, Thickness 252009 = Length =25 Width = 20 Thickness = 09	0 : 0.1 mm 1 : 1.0 mm	A : 2.4GHz ISM Band W : WiMAX	Code from 0~9 dependent on different electrical specification	T : 7" Reeled G:13" Reeled

■ HIGH FREQUENCY MULTILAYER LOW PASS FILTER

RF	LPF	201211	0	A	0	T
<u>Type code</u>	<u>Product code</u>	<u>Dimension code</u>	<u>Unit of dimension</u>	<u>Application</u>	<u>Specification</u>	<u>Packing</u>
RF device	LPF : Low Pass Filter	Per 2 digits of Length, Width, Thickness 201210 = Length =20 Width = 12 Thickness = 11	0 : 0.1 mm 1 : 1.0 mm	A : 2.4GHz ISM Band K : ISM 5.2/5.8 Dual Band	Code from 0~9 dependent on different electrical specification	T : 7" Reeled G:13" Reeled

■ BALUN TRANSFORMERS

RF	BLN	201208	0	A	4	T
<u>Type code</u> RF/RG: device	<u>Product code</u> BLN : BALUN	<u>Dimension code</u> Per 2 digits of Length, Width, Thickness 201208 = Length =20 Width = 12 Thickness = 08	<u>Unit of dimension</u> 0 : 0.1 mm 1 : 1.0 mm	<u>Application</u> A : 2.4GHz ISM Band K : ISM 5.2/5.8 Dual Band	<u>Specification</u> Code from 0~9 dependent on different electrical specification	<u>Packing</u> T : 7" Reeled G:13" Reeled

■ DIPLEXER

RF	DIP	201210	0	L	0	T
<u>Type code</u> RF device	<u>Product code</u> DIP : Diplexer	<u>Dimension code</u> Per 2 digits of Length, Width, Thickness 201210 = Length =20 Width = 12 Thickness = 10	<u>Unit of dimension</u> 0 : 0.1 mm 1 : 1.0 mm	<u>Application</u> L : 2.4/4.9/5.2/5.8GHz Multiband Application	<u>Specification</u> Code from 0~9 dependent on different electrical specification	<u>Packing</u> T : 7" Reeled G:13" Reeled

■ COMMON MODE FILTER

RF	CMF	1210	350	H	0	T
<u>Type code</u> RF/RG: device	<u>Product code</u> CMF : Common Mode Filter	<u>Dimension code</u> Per 2 digits of Length, Width. 1210 = Length =12 Width = 10	<u>Impedance</u> 350:35±25% 650:65±20%	<u>Application</u> H : High Speed Transmission Lines HDMI/MIPI/ mini LVDS/ DVI/ SATA/ PCI-E DVI Display Port X : USD 2.0/IEEE 1394 (mini) LVDS	<u>Specification</u> Code from 0~9 dependent on different electrical specification	<u>Packing</u> T : 7" Reeled

■ THIN FILM COMMON MODE FILTER

RG	TCM	0806	900	H	0	T
<u>Type code</u> RF/RG: device	<u>Product code</u> TCM : Thin Film Common Mode Filter	<u>Dimension code</u> Per 2 digits of Length, Width. 0806 = Length =08 Width = 06	<u>Impedance</u> 350:35±20% 650:65±20% 900:90±25%	<u>Application</u> H : High Speed Transmission Lines HDMI/MIPI/ mini LVDS/ DVI/ SATA/ PCI-E DVI Display Port	<u>Specification</u> Code from 0~9 dependent on different electrical specification	<u>Packing</u> T : Reeled

■ COUPLER

RF	CPL	18	10	B	2450	T
<u>Type code</u> RF device	<u>Product code</u> Coupler	<u>Dimension code</u> e.g. : 18 = Length 16, Width 08, 15= Length 10, Width 05,	<u>Coupling Factor</u> 10 dB	<u>Unit</u> dB	<u>Application</u> 2.4 GHz ISM Band	<u>Packing</u> T : 7" Reeled

■ EMI FILTER ARRAY

RF	EMA	201209	0	R	1	T
Type code RF/RG: device	Product code EMA : EMI Filter Array	Dimension code Per 2 digits of Length, Width, Thickness 201209 = Length =20 Width = 12 Thickness = 09	Unit of dimension 0 : 0.1 mm 1 : 1.0 mm	Application R : 27MHz band	Specification Code from 0~9 dependent on different electrical specification	Packing T: 7" Reeled G:13" Reeled

■ Dipole Antenna

RF	DPA	8709	00	S	B	A	B	8	01
Type code RF device	Product code DPA:Dipole Antenna	Dimension code Per 2 digits of Length, Width 8709 = Length = 87 Width = 9.95	Cable Length code 2 digits for cable length 00= None Cable	Connector Brand code A: N C:MCX D:IPEX III E: IPEX IV F: IPEX A13 H: Hirose I: IPEX K:F M: MMCX S: SMA T: TNC U:MURATA N: None	Type of Connector code A: Reverse Female B: Reverse Male F: Female M: Male N: None	Application code 0: 0GHz 5: 5 GHz A: 2.4GHz ISM band B: GSM 900/1800 dual band G: GPS band L: 2.4/5.2/5.8 GHz tri-band T:LTE band U:UHF W: WCDMA band	Project status code B: MP T:During Test X: Pile Run	Wire Diameter code 0:None 1:Ø0.81 2:Ø1.32 3:Ø1.13 4:Low LossØ1.13 5:Ø0.50 6:RG316 7:Ø1.37 8:RG178 9:Low LossØ1.37 A:RG174 B:1.5C-2V	Project code 01~99 series number

■ PCB Antenna

RF	PCA	4305	10	N	N	A	B	4	01
Type code RF device	Product code PCA:PCB Antenna	Dimension code Per 2 digits of Length, Width 4305 = Length = 43 Width = 5	Cable Length code 2 digits for cable length 10= Cable Length: 10cm	Connector Brand code A: N C:MCX D:IPEX III E: IPEX IV F: IPEX A13 H: Hirose I: IPEX K:F M: MMCX S: SMA T: TNC U:MURATA N: None	Type of Connector code A: Reverse Female B: Reverse Male F: Female M: Male N: None	Application code 0: 0GHz 5: 5 GHz A: 2.4GHz ISM band B: GSM 900/1800 dual band G: GPS band L: 2.4/5.2/5.8 GHz tri-band T:LTE band U:UHF W: WCDMA band	Project status code B: MP T:During Test X: Pile Run	Wire Diameter code 0:None 1:Ø0.81 2:Ø1.32 3:Ø1.13 4:Low LossØ1.13 5:Ø0.50 6:RG316 7:Ø1.37 8:RG178 9: Low LossØ1.37 A:RG174 B:1.5C-2V	Project code 01~99 series number

■ FPA Antenna

RF	FPA	3025	10	I	M	A	B	3	01
<u>Type code</u> RF device	<u>Product code</u> FPA:FPA Antenna	<u>Dimension code</u> Per 2 digits of Length, Width 3025 = Length = 30 Width = 25	<u>Cable Length code</u> 2 digits for cable length 10= Cable Length: 10cm	<u>Connector Brand code</u> A: N C:MCX D:IPEX III E: IPEX IV F: IPEX A13 H: Hirose I: IPEX K:F M: MMCX S: SMA T: TNC U:MURATA N: None	<u>Type of Connector code</u> A: Reverse Female B: Reverse Male F: Female M: Male N: None	<u>Application code</u> 0: 0GHz 5: 5 GHz A: 2.4GHz ISM band B: GSM 900/1800 dual band G: GPS band L: 2.4/5.2/5.8 GHz tri-band T:LTE band U:UHF W: WCDMA band	<u>Project status code</u> B: MP T:During Test X: Pile Run	<u>Wire Diameter code</u> 0:None 1:Ø0.81 2:Ø1.32 3:Ø1.13 4:Low LossØ1.13 5:Ø0.50 6:RG316 7:Ø1.37 8:RG178 9: Low LossØ1.37 A:RG174 B:1.5C-2V	<u>Project code</u> 01~99 series number

■ Metal Antenna

RF	MTA	3109	10	I	M	L	B	7	01
<u>Type code</u> RF device	<u>Product code</u> MTA:Metal Antenna	<u>Dimension code</u> Per 2 digits of Length, Width 3109 = Length = 31 Width = 9	<u>Cable Length code</u> 2 digits for cable length 10= Cable Length: 10cm	<u>Connector Brand code</u> A: N C:MCX D:IPEX III E: IPEX IV F: IPEX A13 H: Hirose I: IPEX K:F M: MMCX S: SMA T: TNC U:MURATA N: None	<u>Type of Connector code</u> A: Reverse Female B: Reverse Male F: Female M: Male N: None	<u>Application code</u> 0: 0GHz 5: 5 GHz A: 2.4GHz ISM band B: GSM 900/1800 dual band G: GPS band L: 2.4/5.2/5.8 GHz tri-band T:LTE band U:UHF W: WCDMA band	<u>Project status code</u> B MP T:During Test X: Pile Run	<u>Wire Diameter code</u> 0:None 1:Ø0.81 2:Ø1.32 3:Ø1.13 4:Low LossØ1.13 5:Ø0.50 6:RG316 7:Ø1.37 8:RG178 9: Low LossØ1.37 A:RG174 B:1.5C-2V	<u>Project code</u> 01~99 series number

■ Cable Assembly

RF	CBA	1613	10	I	M	3	B	7	01
<u>Type code</u> RF device	<u>Product code</u> CBA:Cable Assembly	<u>Dimension code</u> Per 2 digits of Length, Width 1613 = Length = 16.8 Width = 13.7	<u>Cable Length code</u> 2 digits for cable length 10= Cable Length: 10cm	<u>Connector Brand code</u> A: N C:MCX D:IPEX III E: IPEX IV F: IPEX A13 H: Hirose I: IPEX K:F M: MMCX S: SMA T: TNC U:MURATA N: None	<u>Type of Connector code</u> A: Reverse Female B: Reverse Male F: Female M: Male N: None	<u>Application code</u> 0: 0GHz 3: 3GHz 6: 6GHz	<u>Project status code</u> B: MP T:During Test X: Pile Run	<u>Wire Diameter code</u> 0:None 1:Ø0.81 2:Ø1.32 3:Ø1.13 4:Low LossØ1.13 5:Ø0.50 6:RG316 7:Ø1.37 8:RG178 9: Low LossØ1.37 A:RG174 B:1.5C-2V	<u>Project code</u> 01~99 series number

■ Connector

RF	CON	0201	00	D	F	6	B	0	01
<u>Type code</u>	<u>Product code</u>	<u>Dimension code</u>	<u>Cable Length code</u>	<u>Connector Brand code</u>	<u>Type of Connector code</u>	<u>Application code</u>	<u>Project status code</u>	<u>Wire Diameter code</u>	<u>Project code</u>
RF device	CON: Connector	Per 2 digits of Length, Width 0201 = Length = 2.05 Width = 1.40	2 digits for cable length 00= None Cable	A: N C:MCX D:IPEX III E: IPEX IV F: IPEX A13 H: Hirose I: IPEX K:F M: MMCX S: SMA T: TNC U:MURATA N: None	A: Reverse Female B: Reverse Male F: Female M: Male N: None	0: 0GHz 3: 3GHz 6: 6GHz	B: MP T:During Test X: Pile Run	0:None 1:Ø0.81 2:Ø1.32 3:Ø1.13 4:Low LossØ1.13 5:Ø0.50 6:RG316 7:Ø1.37 8:RG178 9: Low LossØ1.37 A:RG174 B:1.5C-2V	01~99 series number

■ NFC Antenna

RF	NFC	5339	00	N	N	N	B	0	01
<u>Type code</u>	<u>Product code</u>	<u>Dimension code</u>	<u>Cable Length code</u>	<u>Connector Brand code</u>	<u>Type of Connector code</u>	<u>Application code</u>	<u>Project status code</u>	<u>Wire Diameter code</u>	<u>Project code</u>
RF device	NFC: Near Field Communication Antenna	Per 2 digits of Length, Width 5339 = Length = 53.7 Width = 39.7	2 digits for cable length 00= None Cable	A: N C:MCX D:IPEX III E: IPEX IV F: IPEX A13 H: Hirose I: IPEX K:F M: MMCX S: SMA T: TNC U:MURATA N: None	A: Reverse Female B: Reverse Male F: Female M: Male N: None	N: NFC	B: MP T:During Test X: Pile Run	0:None 1:Ø0.81 2:Ø1.32 3:Ø1.13 4:Low LossØ1.13 5:Ø0.50 6:RG316 7:Ø1.37 8:RG178 9: Low LossØ1.37 A:RG174 B:1.5C-2V	01~99 series number

■ WPC Antenna

RF	WPC	5830	00	N	N	N	B	0	01
<u>Type code</u>	<u>Product code</u>	<u>Dimension code</u>	<u>Cable Length code</u>	<u>Connector Brand code</u>	<u>Type of Connector code</u>	<u>Application code</u>	<u>Project status code</u>	<u>Wire Diameter code</u>	<u>Project code</u>
RF device	WPC: Wireless Power Charging Antenna	Per 2 digits of Length, Width 5830 = Length = 58 Width = 30	2 digits for cable length 00= None Cable	A: N C:MCX D:IPEX III E: IPEX IV F: IPEX A13 H: Hirose I: IPEX K:F M: MMCX S: SMA T: TNC U:MURATA N: None	A: Reverse Female B: Reverse Male F: Female M: Male N: None	N: NFC	B: MP T:During Test X: Pile Run	0:None 1:Ø0.81 2:Ø1.32 3:Ø1.13 4:Low LossØ1.13 5:Ø0.50 6:RG316 7:Ø1.37 8:RG178 9: Low LossØ1.37 A:RG174 B:1.5C-2V	01~99 series number

Remark :

1. Central Frequency should be defined after customer's application approval

■ STRUCTURE AND PIN ASSOCIATED

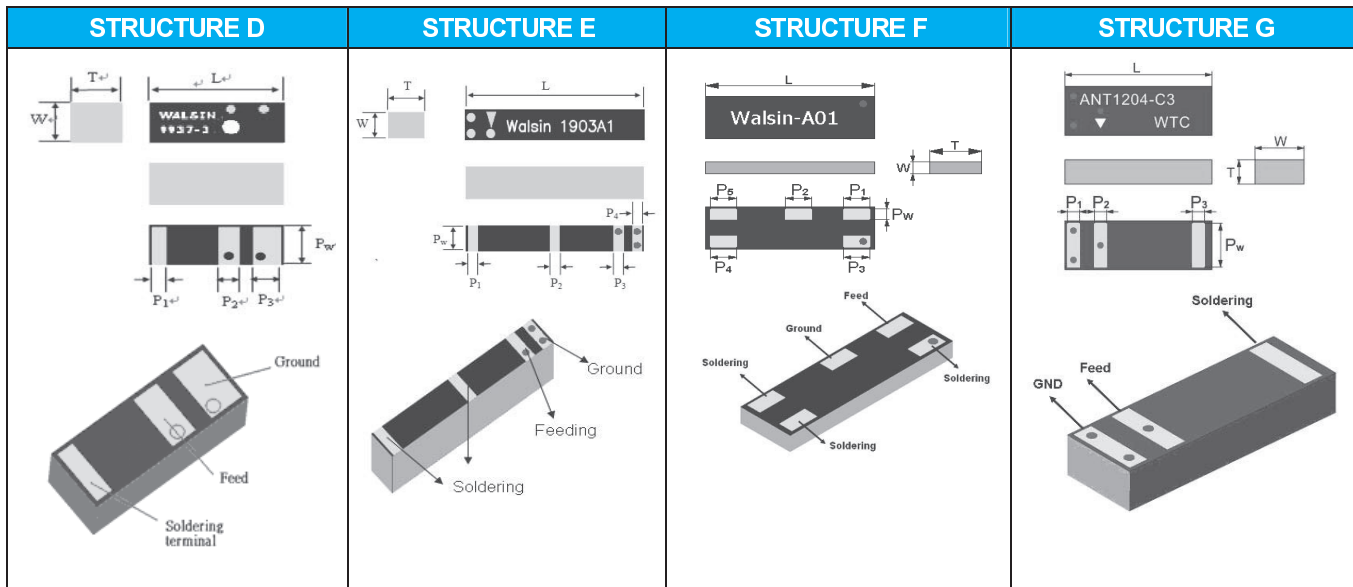
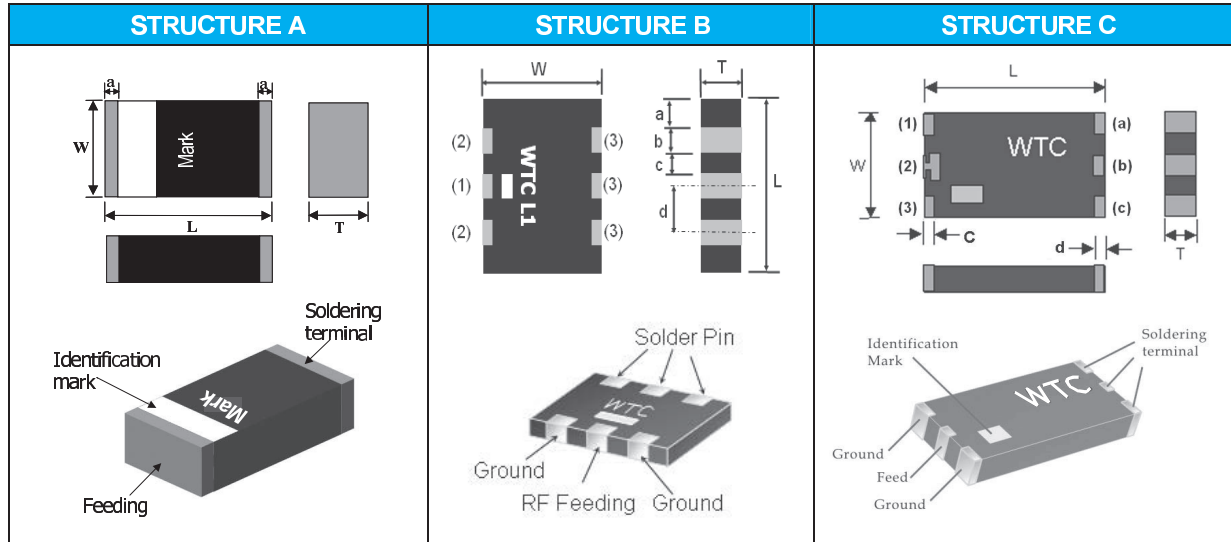

■ STRUCTURE AND DIMENSION

Unit:mm

Structure\ Dimension	L	W	T	a	b	c	d	1	2	3
A	10 ± 0.20	3.2 ± 0.20	0.8 ± 0.10	0.8 ± 0.10						
	3.20 ± 0.20	1.60 ± 0.20	0.60 ± 0.10	0.25 ± 0.20	-	-	-	-	-	-
			1.20 ± 0.10	0.25 ± 0.15	-	-	-	-	-	-
			1.30 ± 0.20	0.40 ± 0.20	-	-	-	-	-	-
	5.20 ± 0.20	2.00 ± 0.20	1.15 ± 0.10	0.40 ± 0.25	-	-	-	-	-	-
			1.15 ± 0.15	0.40 ± 0.25	-	-	-	-	-	-
	5.8 + 0.1 -0.3	3.0+0.1 -0.3	1.1+0.2 -0.1	0.4±0.25	-	-	-	-	-	-
8.00 ± 0.20	1.05 ± 0.20	0.80 ± 0.10	0.30 ± 0.20	-	-	-	-	-	-	
9.50± 0.20	2.10 ± 0.20	1.15 ± 0.10	0.50 ± 0.30	-	-	-	-	-	-	
B	5.9±0.3	5.1±0.3	1.1±0.1	0.45±0.2	1.0±0.2	1.0±0.2	2.0±0.2	1.0±0.2	1.0±0.2	1.0±0.2
C	7.6±0.3	3.5±0.2	1.1±0.1	0.8±0.2	0.8±0.2	0.8±0.2	0.5±0.2	0.5±0.2	0.8±0.2	0.50±0.2

Structure\ Dimension	L	W	T	P _w	P ₁	P ₂	P ₃	P ₄	P ₅
D	9.90±0.15	3.70±0.15	3.80±0.20	3.48±0.10	1.4±0.10	1.9±0.10	2.4±0.15	-	-
E	19.0±0.15	3.00±0.15	3.80±0.20	3.00±0.10	1.0±0.10	1.0±0.10	1.0±0.10	1.0±0.10	-
F	12.8±0.15	3.90±0.15	1.10±0.10	1.00±0.10	2.0±0.10	2.0±0.10	2.0±0.10	2.0±0.10	2.0±0.10
G	12.0±0.15	4.00±0.15	2.00±0.10	3.60±0.10	1.0±0.10	1.0±0.10	1.0±0.10	-	-

■ ELECTRICAL SPECIFICATION

■ 1.575GHz BAND WORKING FREQUENCY

Part Number	Frequency Range (GHz)	Azimuth Beamwidth (MHz)	Gain (dBi)	VSWR (max.)	Impedance (Ω)	Polarization	Size (mm)	Structure
RFANT5830110E0T	1.575	Omni-directional	0 ~ 2	2.0	50	Linear	5.80x3.00x1.10	A
RFECA1003011E0T	1.575	Omni-directional	2 ~ 3	2.0	50	Linear	10.0x3.20x0.80	A
RFECA3216060E□T	1.575	Omni-directional	3	2.0	50	Linear	3.20x1.60x0.60	A

■ Bluetooth/WiFi BAND WORKING FREQUENCY

Part Number	Frequency Range (GHz)	Azimuth Beamwidth (MHz)	Gain (dBi)	VSWR (max.)	Impedance (Ω)	Polarization	Size (mm)	Structure
RFANT6050110L0T	2.4~2.5 4.9~5.9	Omni-directional	4	2.0	50	Linear	5.90x5.10x1.10	B
RFANT6050110L1T	2.4~2.5 4.9~5.9	Omni-directional	4	2.0	50	Linear	5.90x5.10x1.10	B
RFANT3216120A1T	2.4~2.5	Omni-directional	2	2.0	50	Linear	3.20x1.60x1.20	A
RFANT3216120A3T	2.4~2.5	Omni-directional	2	2.0	50	Linear	3.20x1.60x1.20	A
RFANT3216120A5T	2.4~2.5	Omni-directional	2	2.0	50	Linear	3.20x1.60x1.20	A
RFANT5220110A0T	2.4~2.5	Omni-directional	2	2.0	50	Linear	5.20x2.00x1.10	A
RFANT5220110A2T	2.4~2.5	Omni-directional	2	2.0	50	Linear	5.20x2.00x1.10	A
RFANT7635110A1T	2.4~2.5	Omni-directional	0 ~ 2	2.0	50	Linear	7.60x3.50x1.10	C
RFANT8010080A3T	2.4~2.5	Omni-directional	2	2.0	50	Linear	8.00x1.00x0.80	A
RFANT9520120A0T	2.4~2.5	Omni-directional	2	2.0	50	Linear	9.50x2.00x1.20	A
RFECA3216060A1T	2.4~2.5	Omni-directional	2	2.1	50	Linear	3.20x1.60x0.60	A
RFECA3216060K1T	4.9~5.85	Omni-directional	2.8	2.0	50	Linear	3.20x1.60x0.60	A
RGFRA1903041A1T	2.4~2.5	Omni-directional	2	2.0	50	Linear	19.0x3.00x3.80	E
RGFRA1903041A5T	2.4~2.5	Omni-directional	2	2.0	50	Linear	19.0x3.00x3.80	E
RGFRA9937380A3T	2.4~2.55	Omni-directional	2	2.0	50	Linear	9.90x3.70x3.80	D
RGFRA1304011A1T	2.4~2.5	Omni-directional	2	2.1	50	Linear	12.8x3.90x1.10	F
RGFRA1204021A1T	2.4~2.5	Omni-directional	2	2.0	50	Linear	12.0x4.00x2.00	G

■ WIMAX BAND WORKING FREQUENCY

Part Number	Frequency Range (GHz)	Azimuth Beamwidth (MHz)	Gain (dBi)	VSWR (max.)	Impedance (Ω)	Polarization	Size (mm)	Structure
RFANT32162G6W0T	2.5~2.69	Omni-directional	1	3.0	50	Linear	3.20x1.60x1.20	A
RFANT32163G5W0T	3.3~3.8	Omni-directional	2~3	2.0	50	Linear	3.20x1.60x1.20	A

■ For more information, please contact with local sales representative

■ All specifications are subject to change without notice

TYPICAL ELECTRICAL CHARACTERISTICS

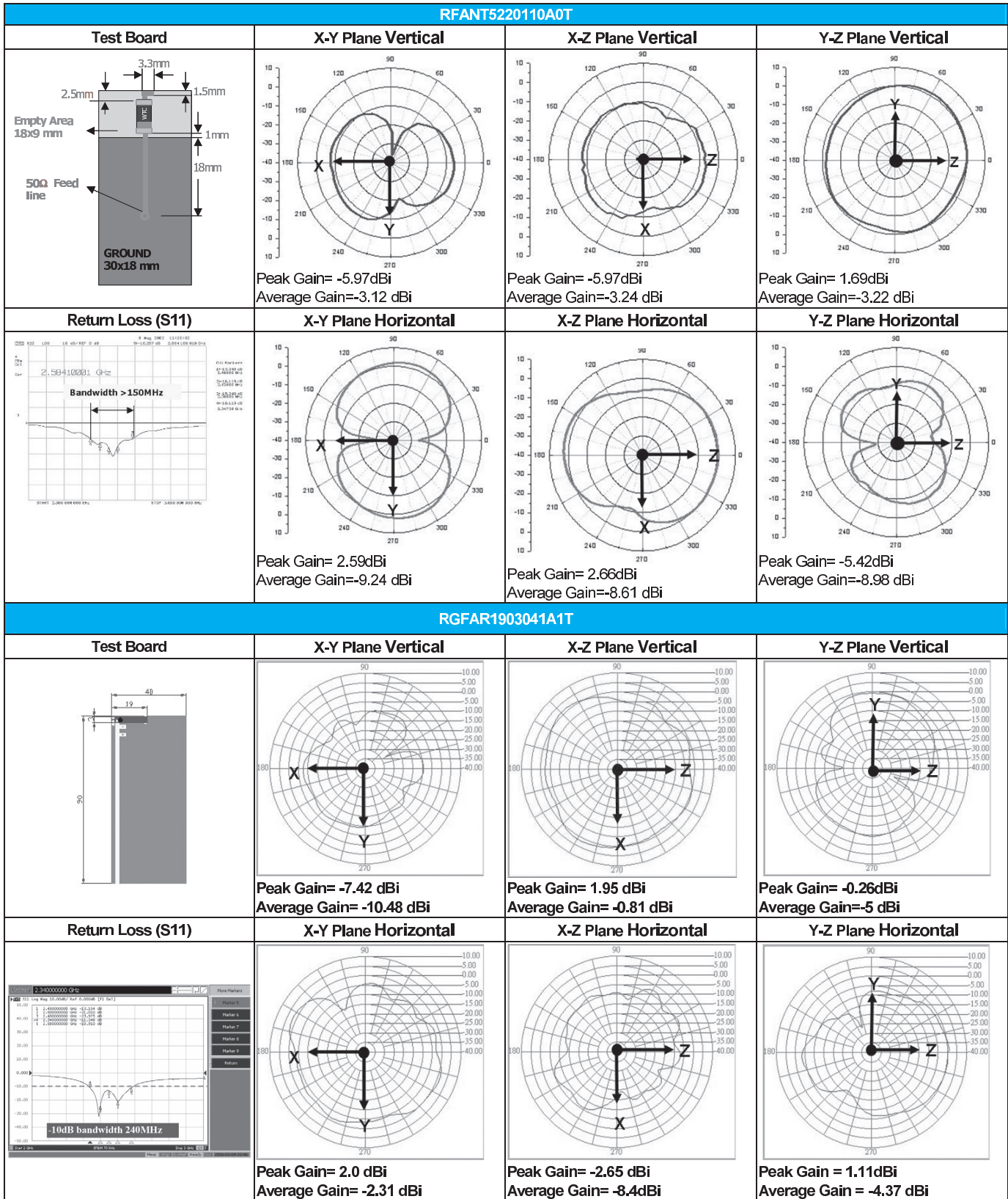

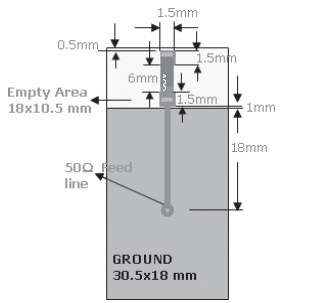
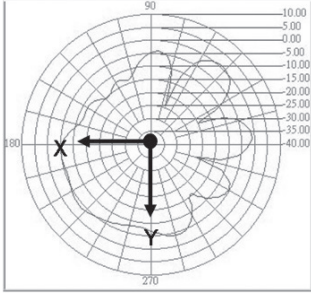
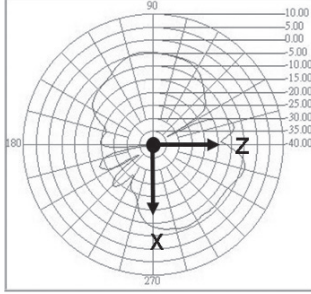
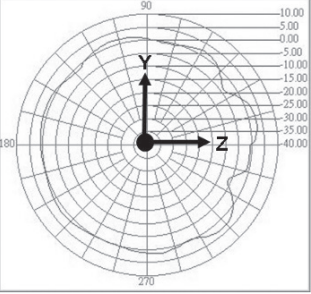
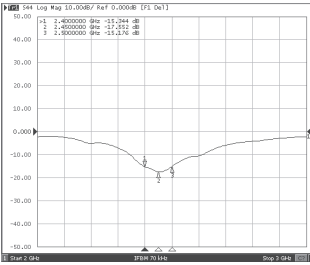
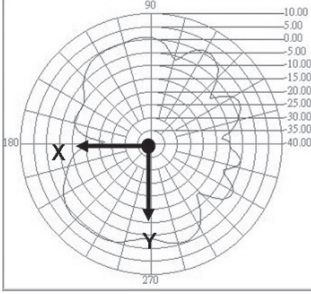
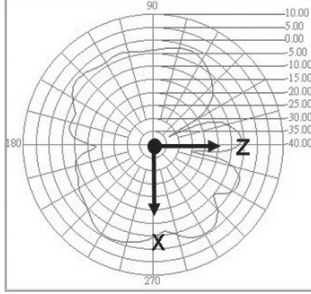
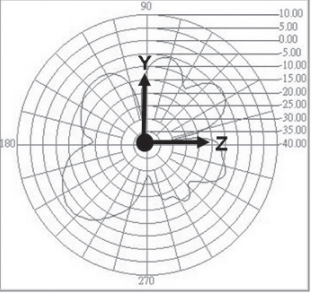
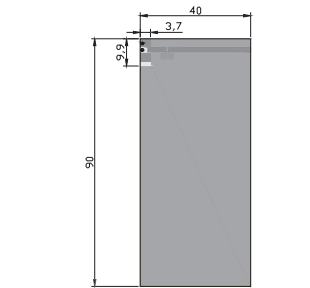
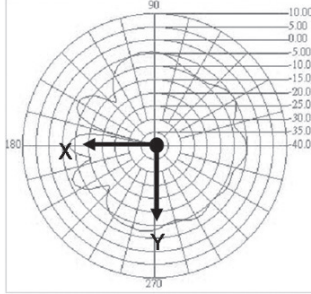
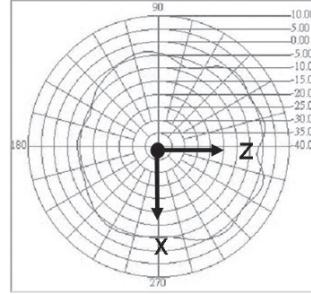
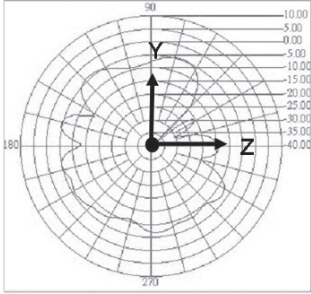
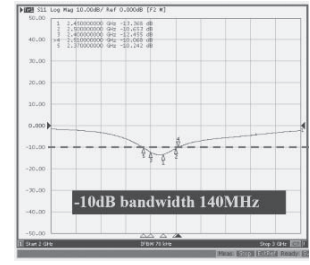
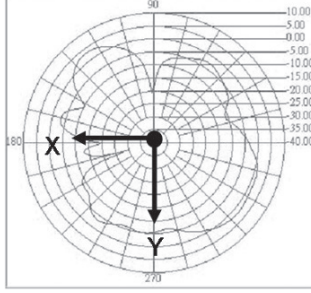
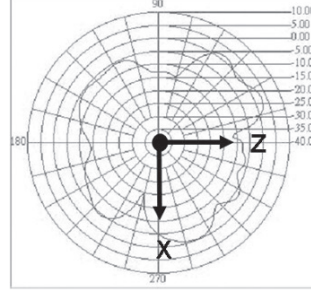
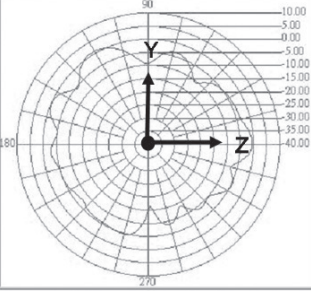
RFANT8010080A3T			
Test Board	X-Y Plane Vertical	X-Z Plane Vertical	Y-Z Plane Vertical
 <p>0.5mm 1.5mm 6mm 1.5mm 1mm 18mm Empty Area 18x10.5 mm 50Ω feed line GROUND 30.5x18 mm</p>	 <p>Peak Gain= 0.76 dBi Average Gain= -5.81dBi</p>	 <p>Peak Gain= -3.76 dBi Average Gain= -8.72dBi</p>	 <p>Peak Gain = 3.03 dBi Average Gain = 0.71 dBi</p>
Return Loss (S11)	X-Y Plane Horizontal	X-Z Plane Horizontal	Y-Z Plane Horizontal
 <p>Peak Loss Log Max 10.000dB Ref 0.000dB (FS On)</p>	 <p>Peak Gain= 1.37 dBi Average Gain= -2.67 dBi</p>	 <p>Peak Gain= -0.25 dBi Average Gain= -4.24 dBi</p>	 <p>Peak Gain= -1.37 dBi Average Gain= -8.6 dBi</p>
RGFAR9937380A3T			
Test Board	X-Y Plane Vertical	X-Z Plane Vertical	Y-Z Plane Vertical
 <p>40 3.7 9.2 90</p>	 <p>Peak Gain= -4.48 dBi Average Gain= -8.02 dBi</p>	 <p>Peak Gain= 2.49 dBi Average Gain= -2.47 dBi</p>	 <p>Peak Gain= -4.05dBi Average Gain=-8.03 dBi</p>
Return Loss (S11)	X-Y Plane Horizontal	X-Z Plane Horizontal	Y-Z Plane Horizontal
 <p>Peak Loss Log Max 10.000dB Ref 0.000dB (FS On)</p> <p>-10dB bandwidth 140MHz</p>	 <p>Peak Gain= 3.19 dBi Average Gain= -2.65 dBi</p>	 <p>Peak Gain= 3.05 dBi Average Gain= -4.10dBi</p>	 <p>Peak Gain = 0.95dBi Average Gain = -4.26 dBi</p>

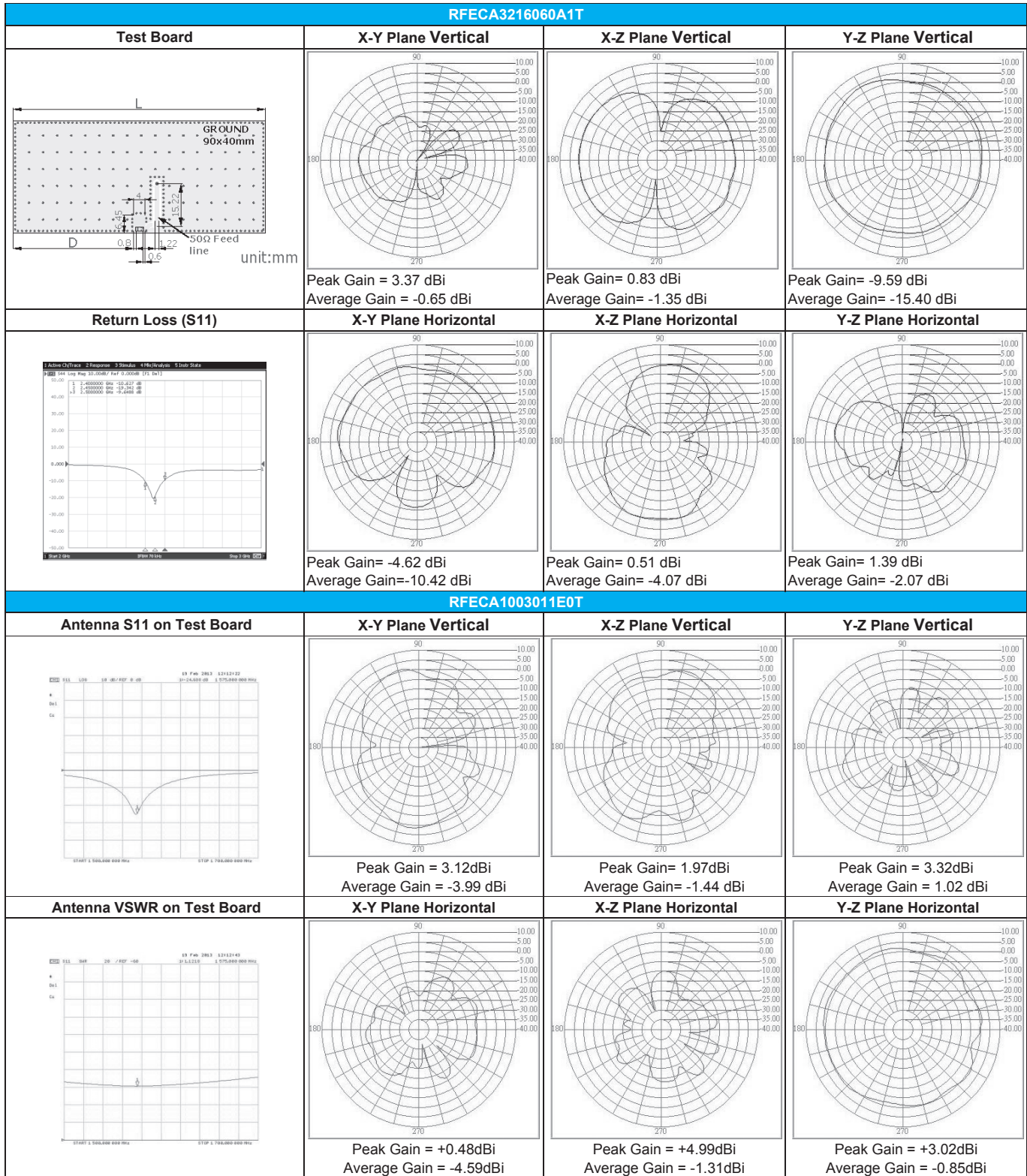

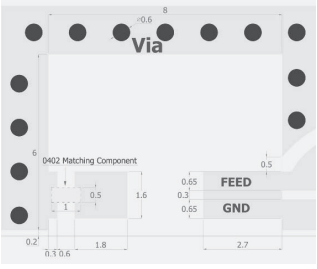
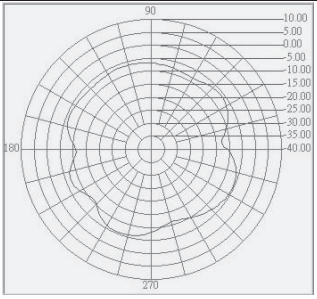
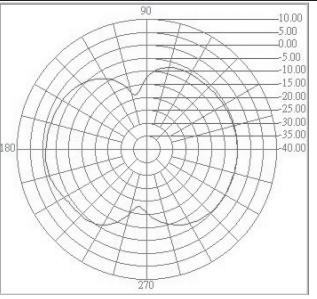
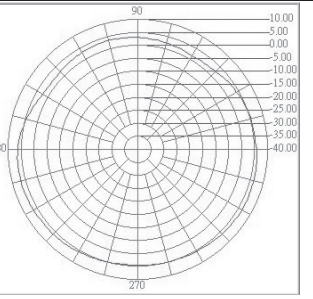
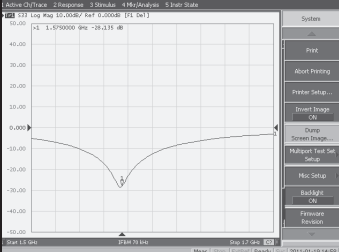
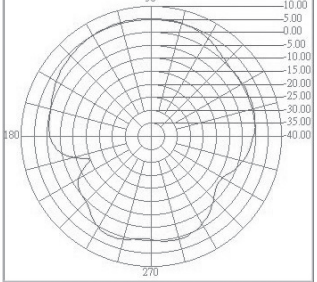
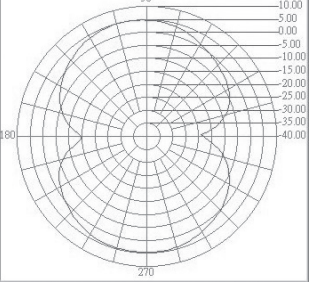
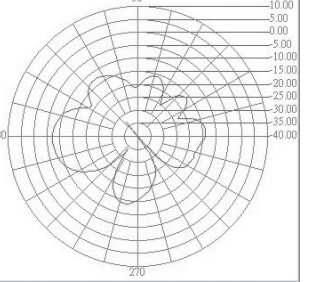
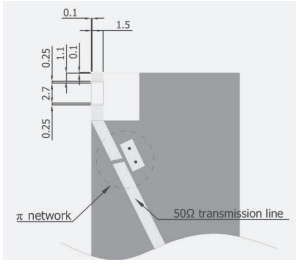
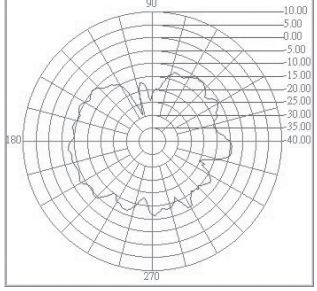
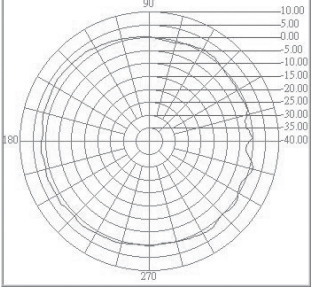
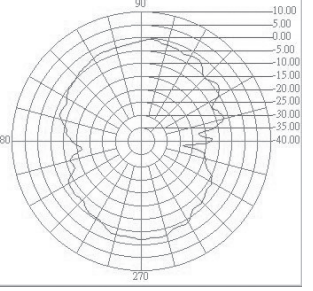
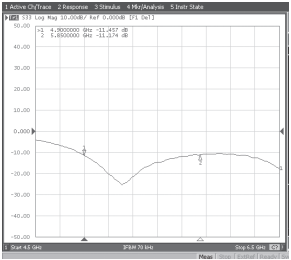
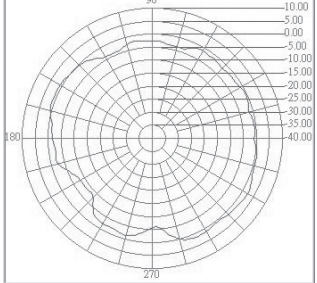
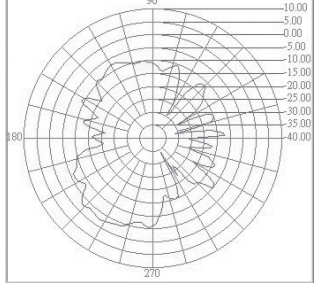
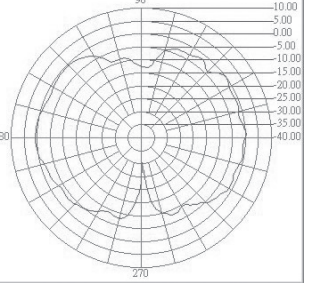
RFECA3216060E1T			
Land Pattern	X-Y Plane Vertical	X-Z Plane Vertical	Y-Z Plane Vertical
	 <p>Peak Gain= -5.51 dBi Average Gain= -7.48 dBi</p>	 <p>Peak Gain= -0.85 dBi Average Gain= -5.22 dBi</p>	 <p>Peak Gain = 6.74 dBi Average Gain = 4.81 dBi</p>
Return Loss (S11)	X-Y Plane Horizontal	X-Z Plane Horizontal	Y-Z Plane Horizontal
	 <p>Peak Gain= 5.36 dBi Average Gain= 1.25 dBi</p>	 <p>Peak Gain= 4.85 dBi Average Gain= 1.21 dBi</p>	 <p>Peak Gain= -6.99 dBi Average Gain= -14.30 dBi</p>
RFCA3216060K1T			
Land Pattern	X-Y Plane Vertical	X-Z Plane Vertical	Y-Z Plane Vertical
	 <p>Peak Gain= -7.42 dBi Average Gain= -11.78 dBi</p>	 <p>Peak Gain= 2.86 dBi Average Gain= 0.86 dBi</p>	 <p>Peak Gain= -0.55dBi Average Gain= -4.9 dBi</p>
Return Loss (S11)	X-Y Plane Horizontal	X-Z Plane Horizontal	Y-Z Plane Horizontal
	 <p>Peak Gain= 2.3 dBi Average Gain= -1.1 dBi</p>	 <p>Peak Gain= -2.49 dBi Average Gain= -9.61 dBi</p>	 <p>Peak Gain = 0.73dBi Average Gain = -2.86 dBi</p>

■ For more information, please contact with local sales representative

■ All specifications are subject to change without notice

HIGH FREQUENCY MULTILAYER BAND PASS FILTER

■ STRUCTURE AND PIN ASSOCIATED

STRUCTURE A	STRUCTURE B	STRUCTURE C	STRUCTURE D	STRUCTURE E

STRUCTURE F	STRUCTURE G	STRUCTURE H	STRUCTURE I

■ STRUCTURE AND DIMENSION

Unit:mm

Structure Dimension	L	W	T	A	B	C	D	E	F	G	H	I
A	2.50±0.20	2.00±0.20	0.70±0.10	0.20±0.20	0.55±0.20	0.50±0.20	0.25±0.20	0.20±0.20	-	-	-	-
			0.80±0.10	0.20±0.20	0.55±0.20	0.50±0.20	0.20±0.20	0.20±0.20	-	-	-	-
			1.00±0.10	0.20±0.20	0.50±0.20	0.50±0.20	0.25±0.20	0.20±0.20	-	-	-	-
			1.05±0.10	0.25±0.20	0.50±0.20	0.50±0.20	0.25±0.20	0.25±0.20	-	-	-	-
			1.20±0.10	0.25±0.20	0.50±0.20	0.50±0.20	0.25±0.20	0.25±0.20	-	-	-	-
	3.20±0.20	2.50±0.10	1.50±0.10	0.40±0.20	0.60±0.20	0.70±0.20	0.20±0.15	0.40±0.20	-	-	-	-
B	1.00±0.10	0.50±0.10	0.40±0.10	0.30±0.10	0.30±0.10	0.35±0.10	0.15±0.10	0.15±0.10	-	-	-	-
	1.60±0.15	0.80±0.15	0.50±0.10	0.35±0.10	0.30±0.10	0.15±0.10	0.15±0.10	0.30±0.10	-	-	-	-
			0.60±0.10	0.45±0.15	0.45±0.15	0.20±0.15	0.20±0.15	0.30±0.15	-	-	-	-
			0.70±0.10	0.45±0.15	0.70±0.15	0.20±0.10	0.20±0.10	0.30±0.15	-	-	-	-
	2.00±.15	1.20±0.15	0.50±0.10	0.40±0.15	0.80±0.15	0.20±0.10	0.20±0.10	0.30±0.15	-	-	-	-
			0.90±0.10	0.45±0.15	1.10±0.15	0.25±0.15	0.25±0.15	0.30±0.15	0.45±0.15	-	-	-
		1.25±0.15	0.60±0.10	0.45±0.15	1.10±0.15	0.25±0.15	0.25±0.15	0.30±0.15	-	-	-	-
			0.80±0.10	0.45±0.15	0.70±0.15	0.20±0.15	0.20±0.15	0.30±0.15	-	-	-	-
			0.90±0.10	0.50±0.15	1.00±0.15	0.25±0.15	0.25±0.15	0.30±0.15	-	-	-	-
			0.95±0.10	0.35±0.15	1.30±0.15	0.25±0.15	0.25±0.15	0.30±0.15	-	-	-	-
				0.50±0.15	1.00±0.15	0.25±0.15	0.25±0.15	0.30±0.15	-	-	-	-
				0.60±0.10	0.45±0.15	0.70±0.15	0.20±0.15	0.20±0.15	0.30±0.15	-	-	-
			0.80±0.10	0.50±0.15	1.00±0.15	0.25±0.15	0.25±0.15	0.30±0.15	-	-	-	-
C	2.00±.15	1.20±0.20	0.55±0.10	0.40±0.20	0.40±0.20	0.40±0.20	0.40±0.20	0.20±0.10	-	-	-	-
			0.60±0.10	0.40±0.20	0.40±0.20	0.40±0.20	0.40±0.20	0.20±0.10	-	-	-	-
			0.80±0.10	0.40±0.20	0.40±0.20	0.40±0.20	0.40±0.20	0.20±0.10	-	-	-	-
D	2.00±.15	1.25±0.10	0.45±0.10	0.95±0.10	0.275±0.20	0.25±0.10	0.60±0.10	0.175±0.10	0.15±0.10	-	-	-
			0.70 max	0.95±0.10	0.275±0.10	0.25±0.10	0.60±0.10	0.175±0.10	0.15±0.10	-	-	-
			0.80±0.10	0.95±0.10	0.275±0.10	0.25±0.10	0.60±0.10	0.175±0.10	0.15±0.10	-	-	-
E	1.40±0.15	1.10±0.15	0.60±0.10	0.325±0.10	-	0.25±0.10	0.25±0.10	0.25±0.10	0.25±0.10	0.25±0.10	0.25±0.10	-
	2.00±0.15	1.25±0.10	0.80±0.10	0.325±0.10	0.375±0.10	0.25±0.10	0.25±0.10	0.25±0.10	0.25±0.10	0.25±0.10	0.25±0.10	0.20±0.10
F	1.60±0.15	0.80±0.15	0.40±0.10	0.55±0.15	0.50±0.15	0.35±0.15	0.50±0.15	0.20±0.15	-	-	-	-
	1.60±0.15	0.80±0.15	0.60±0.10	0.55±0.15	0.50±0.15	0.35±0.15	0.50±0.15	0.20±0.15	-	-	-	-
G	2.00±0.15	1.25±0.10	0.80±0.10	0.95±0.10	0.40±0.10	0.30±0.10	0.30±0.10	0.15±0.10	0.30±0.10	0.35±0.10	0.15±0.10	-
	2.00±0.15	1.25±0.10	0.90±0.10	0.95±0.10	0.40±0.10	0.30±0.10	0.30±0.10	0.15±0.10	0.30±0.10	0.35±0.10	0.15±0.10	-
	2.50±0.20	2.00±0.20	0.90±0.10	1.70±0.20	0.60±0.20	0.30±0.20	0.40±0.20	0.15±0.10	0.60±0.10	0.50±0.10	0.15±0.10	-
H	1.60±0.15	0.80±0.10	0.60 max	0.25±0.10	0.23±0.05	0.40±0.10	0.30±0.10	0.55±0.10	0.60±0.10	-	-	-
I	2.00±0.15	1.25±0.10	1.00 max.	1.80±0.10	0.35±0.10	0.25±0.10	0.25±0.10	0.275±0.10	0.35±0.10	0.25±0.10	0.25±0.10	0.275±0.10

■ ELECTRICAL SPECIFICATION

■ DVB BAND WORKING FREQUENCY

Part Number	Frequency Range(GHz)	Insertion Loss (dB)	Attenuation (dB min.)	VSWR (max.)	Impedance (Ω)	Size(mm)	STRUCTURE
RFBPF2520080Y0T	0.465~0.862	1.2	30(90 MHz) 10(245 MHz) 30(2170 MHz)	2.0	50	2.50x2.00x0.80	A

■ 1.8GHz BAND WORKING FREQUENCY

Part Number	Frequency Range(GHz)	Insertion Loss (dB)	Attenuation (dB min.)	VSWR (max.)	Impedance (Ω)	Size(mm)	STRUCTURE
RFBPF2520070SOT	1.8/ 1.9	2.1	40(400~850 MHz) 35(850~1190 MHz) 8(1190~1590 MHz) 25(2410~3400 MHz) 40(3400~6000 MHz)	2.0	50	2.50x2.00x0.70	A

■ 2.4GHz BAND WORKING FREQUENCY

Part Number	Frequency Range(GHz)	Insertion Loss (dB)	Attenuation (dB min.)	VSWR (max.)	Impedance (Ω)	Size(mm)	STRUCTURE
RBBPF1005040A1T	2.4~2.5	2.5	25(824~960 MHz) 20(1710~1910 MHz) 20(4800~5000 MHz)	2.0	50	1.00x0.50x0.40	B
RFBPF1411060A1T	2.4~2.5	1.8	40(824~960MHz) 40(1545~1605MHz) 20(1710~1990MHz) 8(2110~2170MHz) 35(3600 MHz) 35(4800~5000 MHz) 35(7200~7500 MHz)	2.0	50	1.40x1.10x0.60	E
RFBPF1608060AM1T59	2.4~2.5	3.0	38(900~1800 MHz) 25(1910~2170 MHz) 35(4800~4900 MHz)	2.0	50	1.60x0.80x0.60	B
RFBPF1608060AA7M1U	2.4~2.5	0.95max.(25°C) 1.25max.(-40~+85°C)	20(500~960 MHz) 23(3200 MHz) 30(4800~5000 MHz) 32(7200~7500 MHz)	2.0	50	1.60x0.80x0.60	H
RFBPF1608060ADT	2.4~2.5	1.8max(25°C) 2.1max.(-40~+85°C)	22.5(200~1300MHz) 5.5(2000MHz) 10.5(3000MHz) 23.5(3600~3800MHz) 35(4800~5000MHz) 35(7200~7500MHz)	2.0	50	1.60x0.80x0.60	B
RFBPF1608060AET	2.4~2.5	1.7max.(25□) 2.0max.(-40~+85□)	25(880 MHz) 20(3200 MHz) 35(4800~5000 MHz) 25(7200~7500 MHz)	2.0	50	1.60x0.80x0.60	F
RFBPF1608070AFT	2.4~2.5	2.4max.(25°C) 2.7max.(-40~+85°C)	24.5(80~960MHz) 20(1710~1990 MHz) 8.5(2170 MHz) 15(4800~5000 MHz) 20(7200~7500 MHz)	2.0	50	1.60x0.80x0.70	B
RFBPF1608070AWT	2.4~2.5	2.0max.(25°C) 2.2max.(-40~+85°C)	30 (960 MHz) 25(1910 MHz) 20(1990 MHz) 25(4800 MHz) 15(7200 MHz)	2.0	50	1.60x0.80x0.70	B
RFBPF1608050A0T	2.4~2.5	2.0max.(25°C) 2.2max.(-40~+85°C)	20(960 MHz) 20(1910 MHz) 15(1990 MHz) 18(4800 MHz) 25(7200 MHz)	2.0	50	1.60x0.80x0.50	B
RFBPF1608060A1T	2.4~2.5	2.8	25(695~800MHz) 20(1910MHz) 35(3200MHz) 20(4800~5000MHz) 20(7200~7500MHz)	2.0	50	1.60x0.80x0.60	B
RFBPF1608060A7T	2.4~2.5	3.0	25(695~800MHz) 20(1910MHz) 35(3200MHz) 20(4800~5000MHz) 20(7200~7500MHz)	2.0	50	1.60x0.80x0.60	B
RFBPF1608060A8T	2.4~2.5	1.7	30(880~915MHz) 30(1710~1785MHz) 25(1850~1910MHz) 25(4800~5000MHz) 15(7200~7500MHz)	2.0	50	1.60x0.80x0.60	B
RFBPF1608070A3T	2.4~2.5	1.8max.(25°C) 2.1max.(-40~+85°C)	27(800~900 MHz) 25(4800~5000 MHz) 30(7200~7500 MHz)	2.0	50	1.60x0.80x0.70	B

Part Number	Frequency Range(GHz)	Insertion Loss (dB)	Attenuation (dB min.)	VSWR (max.)	Impedance (Ω)	Size(mm)	STRUCTURE
RFBPF2012080AM0T62	2.4~2.5	1.8max.(25°C) 2.0max. (-40~+85°C)	30(860~ 960MHz) 30(1545~ 1605MHz) 35(1710~ 1990MHz) 30(2170MHz) 30(4800~ 5000MHz)	2.0	50	2.00x1.20x0.80	D
RFBPF2012080AC2T00	2.4~2.5	1.35max.	30(804~ 828 MHz) 20(1608~1656 MHz) 30(3216~ 3312 MHz) 40(4020~ 4140 MHz) 20(4824~ 4968 MHz) 20(5628 ~ 5796 MHz) 20(6432 ~ 6624 MHz) 35(7200 ~ 7500 MHz) 20(7500 ~ 10000 MHz)	2.0	50	2.00x1.25x0.80	G
RFBPF2012090AS1T35	2.4~2.5	0.9max.(25°C) 1.1max.(-40~+85°C)	28(824~960MHz) 30(1570~1580MHz) 15(1710~1910MHz) 9.5(1910~1990MHz) 25(4800~5000MHz) 25(7200~7500MHz)	2.0	50	2.00x1.25x0.90	G
RFBPF2012060AAT	2.4~2.5	1.5max.(25°C) 1.8max.(-40~+85°C)	30(880~960MHz) 25(1710~1910MHz) 25(4800~5000MHz) 30(7200~7500MHz)	2.0	50	2.00x1.20x0.60	C
RFBPF2012040ABT	2.4~2.5	2.5	30(824~849 MHz) 30(880~915 MHz) 30(1545~1605 MHz) 30(1565~1585 MHz) 35(1710~1785 MHz) 40(1850~1910 MHz) 32(1920~1980 MHz) 7(3168~4752 MHz) 11(3300~3800 MHz) 35(4800~4967 MHz) 26(5150~6000 MHz) 23(7200~7450 MHz)	2.0	50	2.00x1.20x0.40	D
RFBPF2012050ACT	2.4~2.5	2.5	35(824~960 MHz) 38(1710~1910 MHz) 25(4880~5000 MHz) 20(7200~7500 MHz)	2.0	50	2.00x1.20x0.55	C
RFBPF2012080ADT	2.4~2.5	1.5max.(25°C) 1.7max.(-40~+85°C)	30(860~ 960MHz) 30(1545~ 1605MHz) 30(1710~ 1990MHz) 30(2170MHz) (typical) 30(4800~ 5000MHz)	2.0	50	2.00x1.25x0.80	D
RFBPF2012080AFT	2.4~2.5	1.8max.(25°C) 2.0max.(-40~+85°C)	30(824~ 915MHz) 30(1545~ 1605MHz) 35(1710~ 1990MHz) 30(2170MHz) 30(4800~ 4967MHz) 25(5150 ~ 6000MHz) 20(7200~ 7450.5MHz)	2.0	50	2.00x1.25x0.80	D
RFBPF2012080AGT	2.4~2.5	1.8max.(typ.1.5)	35(824~960MHz) 28(1545~ 1605MHz) 30(1710~ 1990MHz) 30(2170MHz) 6(3200MHz) 30(4800~ 4967MHz) 20(5150 ~ 6000MHz) 18(7200~ 7450MHz)	2.0	50	2.00x1.25x0.80	D
RFBPF2012040AHT	2.4~2.5	2.5	25(746~764 MHz) 30(824~849 MHz) 26(869~960 MHz) 28(1570~1580 MHz) 28(1710~1785 MHz) 30(1850~1910 MHz) 30(1930~1990 MHz) 30(2110~2170 MHz) 15(3300~3800 MHz) 35(4800~5000 MHz) 20(7200~7450.5 MHz)	2.0	50	2.00x1.25x0.45	D
RFBPF2012090ALT	2.4~2.5	1.0max.(25°C) 1.2max.(-40~+85°C)	28(824 ~ 960MHz) 28(1570 ~ 1580MHz) 23(1710 ~ 1910MHz) 17(1920~ 1990MHz) 25(4800 ~ 5000MHz)	2.0	50	2.00x1.25x0.90	G
RFBPF2012090AMT	2.4~2.5	2.6	40(880~960 MHz) 38(1710~1990 MHz) 16(2170 MHz) 30(4800~5000 MHz) 25(7200~7500 MHz)	2.0	50	2.00x1.20x0.90	B

Part Number	Frequency Range(GHz)	Insertion Loss (dB)	Attenuation (dB min.)	VSWR (max.)	Impedance (Ω)	Size(mm)	STRUCTURE
RFBPF2012100ANT	2.4~2.5	2.3max.(25°C) 2.6max.(-40~+85°C)	40(699~ 960MHz) 40(1428~1448MHz) 40(1476~ 1607MHz) 40(1710~ 1785MHz) 33(1805~1880MHz) 30(1880~1915MHz) 30(1920~1990MHz) 22(2110~2170MHz) 25(4800~ 5000MHz) 35(7200~7500MHz)	2.0	50	2.00x1.20x1.00	I
RFBPF2012090AQT	2.4~2.5	1.2	20(1600 MHz) 25(3200 MHz) 20(4800~5000 MHz)	2.0	50	2.00x1.20x0.90	B
RFBPF2012090ART	2.4~2.5	1.0	20(1600 MHz) 25(3200 MHz)	2.0	50	2.00x1.20x0.90	B
RFBPF2012100AVT	2.4~2.5	2.3max.(25°C) 2.6max.(-40~+85°C)	40(699~ 960MHz) 40(1428~1448MHz) 40(1476~ 1607MHz) 40(1710~ 1785MHz) 33(1805~1880MHz) 30(1880~1915MHz) 30(1920~1990MHz) 25(4800~ 5000MHz) 30(7200~7500MHz)	2.0	50	2.00x1.20x1.00	I
RFBPF2012090A1T	2.4~2.5	1.7	30(900 MHz) 20(1850 MHz) 30(4800 MHz)	2.0	50	2.00x1.20x0.90	B
RFBPF2012090A2T	2.4~2.5	1.4	30(824~960MHz) 30(1710~1910 MHz) 20(1920~1990 MHz) 6(2110~2170MHz) 20(4800~5000 MHz)	2.0	50	2.00x1.20x0.90	B
RFBPF2012040A3T	2.4~2.5	2.0max.(25°C) 2.2max.(-40~+85°C)	25(746~ 764MHz) 30(824~ 849MHz) 26(869~ 960MHz) 28(1570~ 1580MHz) 28(1710~ 1785MHz) 30(1850~ 1910MHz) 30(1930~ 1990MHz) 25(2110~ 2170MHz) 15(3300~ 3800MHz) 35(4800~ 5000MHz) 20(7200~7450.5MHz)	2.0	50	2.00x1.25x0.45	D
RFBPF2012080A5T	2.4~2.5	3.0	40(880~960 MHz) 40(1710~1990 MHz) 20(2110~2170 MHz) 40(4800~5000 MHz) 30(7200~7500 MHz)	2.0	50	2.00x1.20x0.80	C
RFBPF2012080A6T	2.4~2.5	3.5	30(880~960 MHz) 30(1710~1990 MHz) 20(2110~2170 MHz) 30(4800~5000 MHz) 30(7200~7500 MHz)	2.0	50	2.00x1.20x0.80	C
RFBPF2012080A7T	2.4~2.5	2.8 (typ.2.5)	40(DC~1600 MHz) 35(1710 MHz) 25(1900 MHz) 12(2100 MHz) 8(2170 MHz) 30(3100 MHz) 40(4800~5000 MHz) 20(7200~7500 MHz)	2.0	50	2.00x1.20x0.80	B
RFBPF2012060A9T	2.4~2.5	2.8	30(960 MHz) 30(1600 MHz) 20(1990 MHz) 35(3200 MHz) 40(4800 MHz) 25(7200 MHz)	2.0	50	2.00x1.20x0.60	B

Part Number	Frequency Range(GHz)	Insertion Loss (dB)	Attenuation (dB min.)	VSWR (max.)	Impedance (Ω)	Size(mm)	STRUCTURE
RFBPF2520090ACT	2.4~2.5	2.1max.(25°C) 2.3max.(-40~+85°C)	43(806~960MHz) 43(1570~1580 MHz) 43(1710~1990 MHz) 20(2110~2170MHz) 30(4800~5000 MHz) 25(7200~7500MHz)	2.0	50	2.50x2.00x0.90	G
RFBPF2520070AMT	2.4~2.5	2.0max.(25°C) 2.2max.(-40~+85°C)	45(824~960 MHz) 45(1570~1580 MHz) 45(1710~1785 MHz) 40(1805~1850 MHz) 35(1850~1910 MHz) 35(1920~1990 MHz) 25(2110~2170 MHz) 5(2750~3000 MHz) 15(3000~4800 MHz) 30(4800~5000 MHz) 30(5150~5850 MHz) 20(7200~7500 MHz)	2.0	50	2.50x2.00x0.70	A
RFBPF2520080AUT	2.4~2.5	2.2	30(900 MHz) 30(1850 MHz) 33(2170 MHz) 35(4800 MHz) 25(7200 MHz)	2.0	50	2.50x2.00x0.80	A
RFBPF2520120A1T	2.4~2.5	1.7	30(900/1850 MHz) 20(2100 MHz) 40(4800 MHz) 25(7200 MHz)	2.0	50	2.50x2.00x1.20	A
RFBPF2520120A2T	2.4~2.5	2.1	30(900/1850 MHz) 30(4800 MHz)	2.0	50	2.50x2.00x1.20	A
RFBPF2520120A3T	2.4~2.5	≤1.2(25°C)	30(900/1850 MHz) 25(4800 MHz)	2.0	50	2.50x2.00x1.20	A
RFBPF2520120A4T	2.4~2.5	≤1.7(25°C)	30(900/1850 MHz) 25(4800 MHz)	2.0	50	2.50x2.00x1.20	A
RFBPF2520100A5T	2.4~2.5	2.0	40(900 MHz) 35(3200 MHz) 30(1990 MHz) 20(2100 MHz) 40(4800 MHz) 25(7200 MHz)	2.0	50	2.50x2.00x1.00	A
RFBPF2520100A6T	2.4~2.5	1.4	35(1900/4800 MHz)	2.0	50	2.50x2.00x1.00	A
RFBPF3225150A3T	2.4~2.5	2.5	40(1500 MHz) 30(2100 MHz) 30(4800 MHz)	1.7	-	3.20x2.50x1.50	A
RFBPF3225150A4T	2.4~2.5	2.0	30(900 MHz) 30(1850 MHz) 20(2100 MHz) 30(4800 MHz)	2.0	50	3.20x2.50x1.50	A
RFBPF3225150A5T	2.4~2.5	1.8	30(900 MHz) 30(1850MHz) 20(2100 MHz) 30(4800 MHz)	2.0	50	3.20x2.50x1.50	A

■ 1558 ~ 1606 MHz GNSS Band Applications

Part Number	Frequency Range(GHz)	Insertion Loss (dB)	Attenuation (dB min.)	VSWR (max.)	Impedance (Ω)	Size(mm)	STRUCTURE
RFBPF2012080E1T	1558 ~ 1606	1.8max.(25°C) 2.0max.(-40~+85°C)	30(824~849 MHz) 30(880~915 MHz) 30(1850~1910 MHz) 30(1920~1980 MHz) 30(2400MHz)	2.0	50	2.00x1.25x0.80	E

HIGH FREQUENCY MULTILAYER BAND PASS FILTER

■ 5GHz BAND WORKING FREQUENCY

Part Number	Frequency Range(GHz)	Insertion Loss (dB)	Attenuation (dB min.)	VSWR (max.)	Impedance (Ω)	Size(mm)	STRUCTURE
RFBPF1608060K2T	4.9~5.84	1.5max.(25°C) 1.7max.(-40~+85°C)	33(100~2170 MHz) 29(2170~2500 MHz) 32(9800~12000 MHz)	2.0	50	1.60x0.80x0.70	B
RFBPF2012100KST	4.9~5.9	1.5(4.90GHz) 1.5(5.25GHz) 1.5(5.85GHz)	30(3450 MHz) 20(11000 MHz)	2.0	50	2.00x1.20x1.00	B
RFBPF2012100K1T	5.15~5.9	3.0 (typ.2.5)	35(4000MHz) 35(4500MHz) 40(4600MHz)	2.0	50	2.00x1.20x1.00	B
RFBPF2012090K5T	4.9~5.85	2.2	35(340~1195 MHz) 19(2140~3580 MHz) 25(6855~7150 MHz) 20(8570~8930 MHz)	2.0	50	2.00x1.20x0.90	B
RFBPF2012100K3T	4.9~5.85	1.8max.(25°C) 2.1max.(-40~+85°C)	30(500 MHz) 35(3450 MHz) 30(4000 MHz) 20(4200 MHz) 15(9800 MHz) 15(11700 MHz)	2.0	50	2.00x1.20x0.95	B
RFBPF2012100K6T	5.15~5.85	1.6max.(25°C) 1.8max.(-40~+85°C)	30(500 MHz) 40(2000 MHz) 35(3450 MHz) 30(4000 MHz) 20(4200 MHz)	2.0	50	2.00x1.20x0.95	B
RFBPF2012090K9T	5.725~5.85	2.0	30(500 MHz) 30(4000 MHz) 20(4200 MHz) 32(5000 MHz) 15(9800 MHz) 15(11750 MHz)	2.0	50	2.00x1.20x0.95	B
RFBPF2520090K1T	4.9~5.85	1.2	47(824 MHz) 47(1500 MHz) 47(1910 MHz) 15(9800 MHz)	2.0	50	2.50x2.00x0.90	A

■ WIMAX BAND WORKING FREQUENCY

Part Number	Frequency Range(GHz)	Insertion Loss (dB)	Attenuation (dB min.)	VSWR (max.)	Impedance (Ω)	Size(mm)	STRUCTURE
RFBPF16082G3W0T	2.3~2.39	2.0	29(880~915 MHz) 29(1710~1785 MHz) 21(1850~1910 MHz) 15(1920~1980 MHz) 18(4600~4780 MHz) 23(6900~7170 MHz)	2.0	50	1.60x0.80x0.70	B
RFBPF20122G5W0T	2.3~2.69	2.0	20(1600 MHz) 30(3490 MHz) 30(4000 MHz) 30(4490 MHz) 30(8000 MHz)	2.0	50	2.00x1.20x0.50	B

■ For more information, please contact with local sales representative

■ All specifications are subject to change without notice

TYPICAL ELECTRICAL CHARACTERISTICS

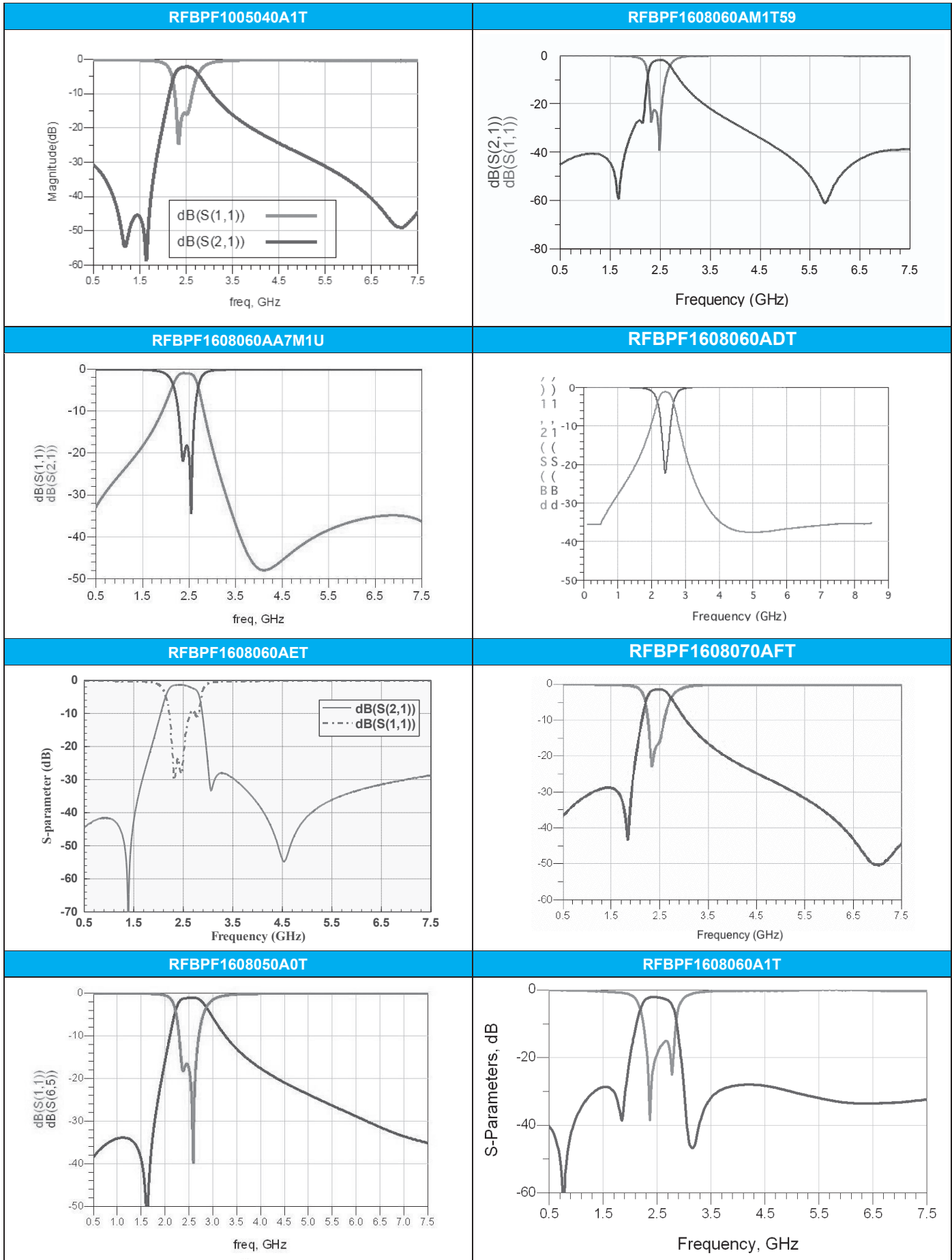

HIGH FREQUENCY MULTILAYER BAND PASS FILTER

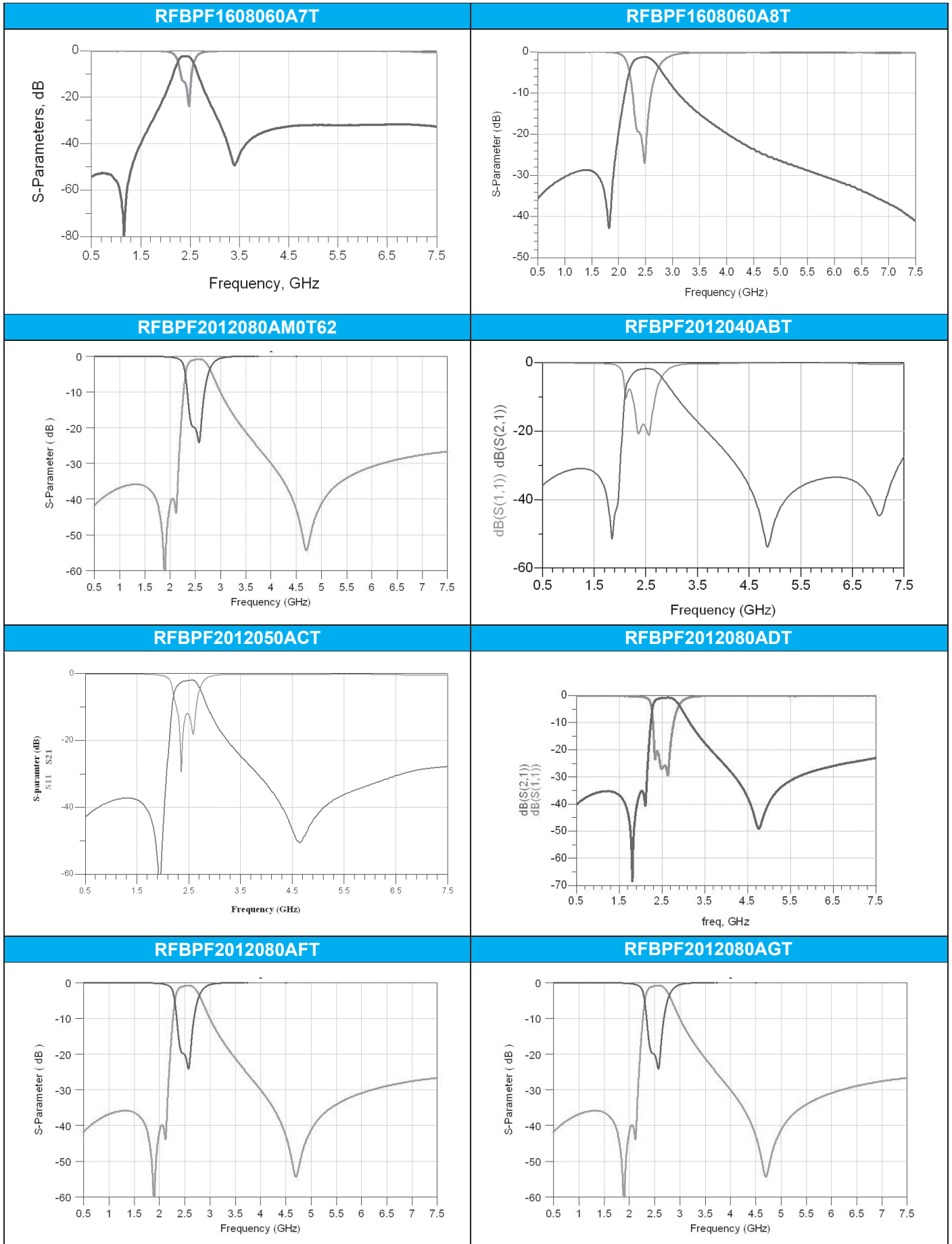

HIGH FREQUENCY MULTILAYER BAND PASS FILTER

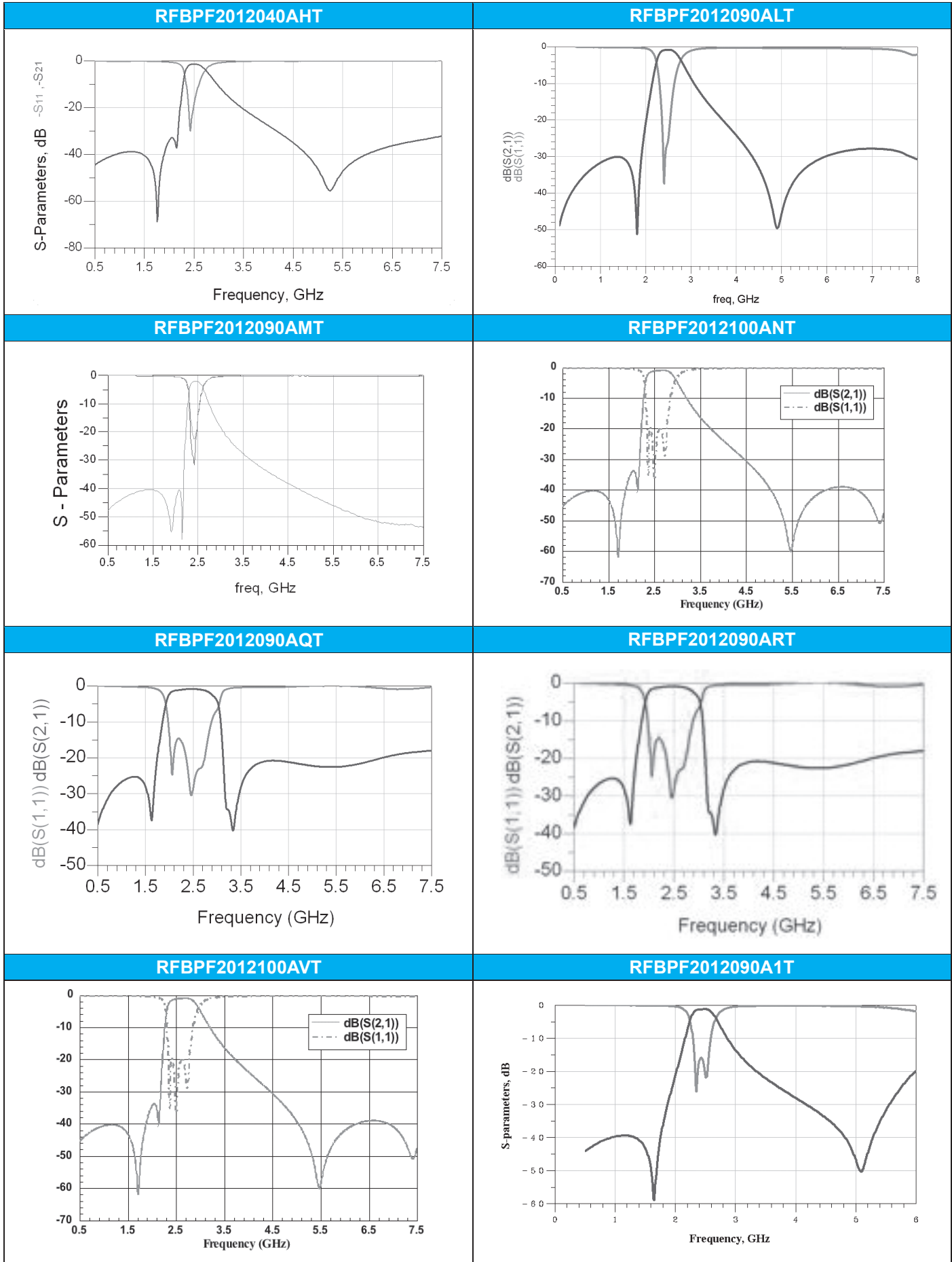

HIGH FREQUENCY MULTILAYER BAND PASS FILTER

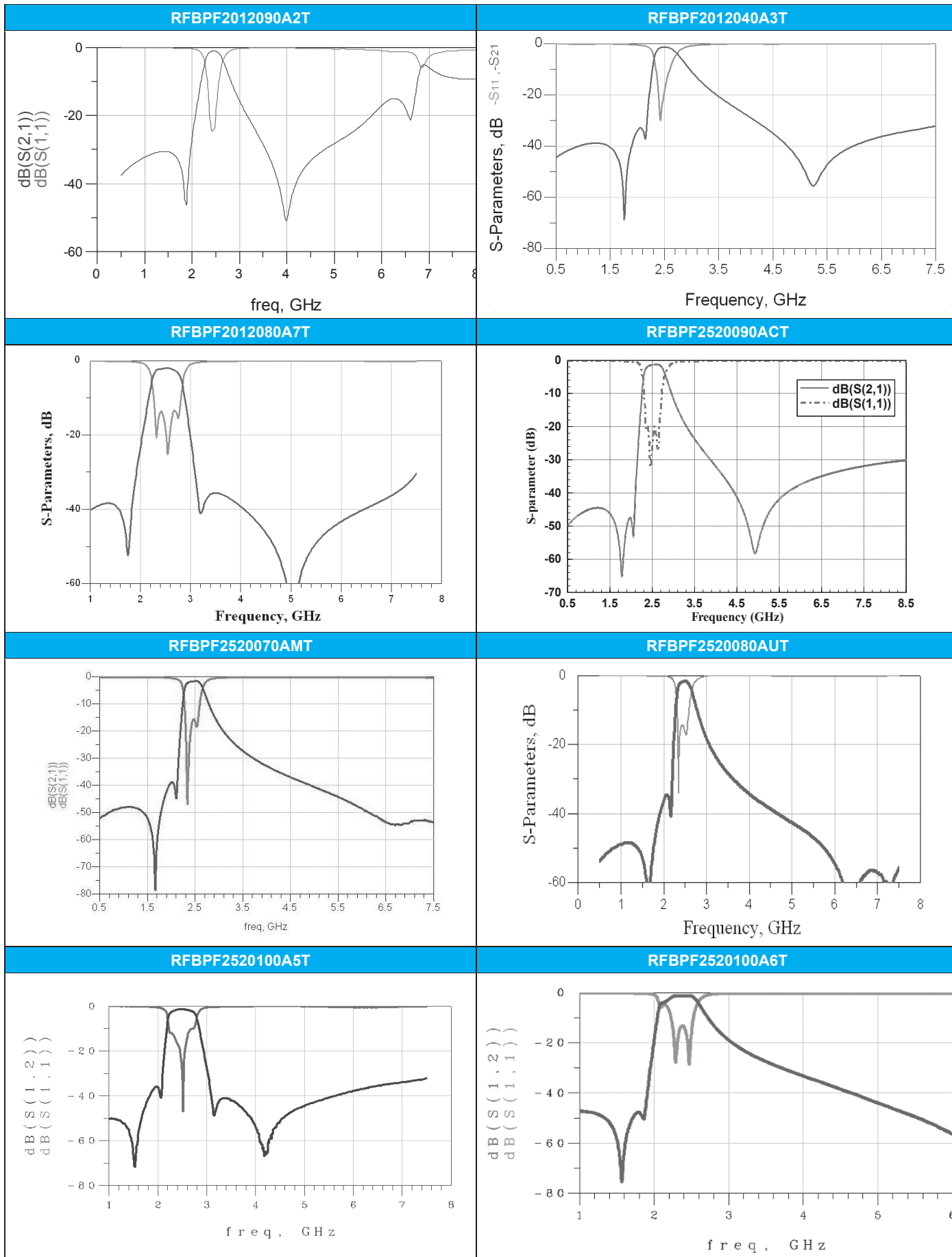

HIGH FREQUENCY MULTILAYER BAND PASS FILTER

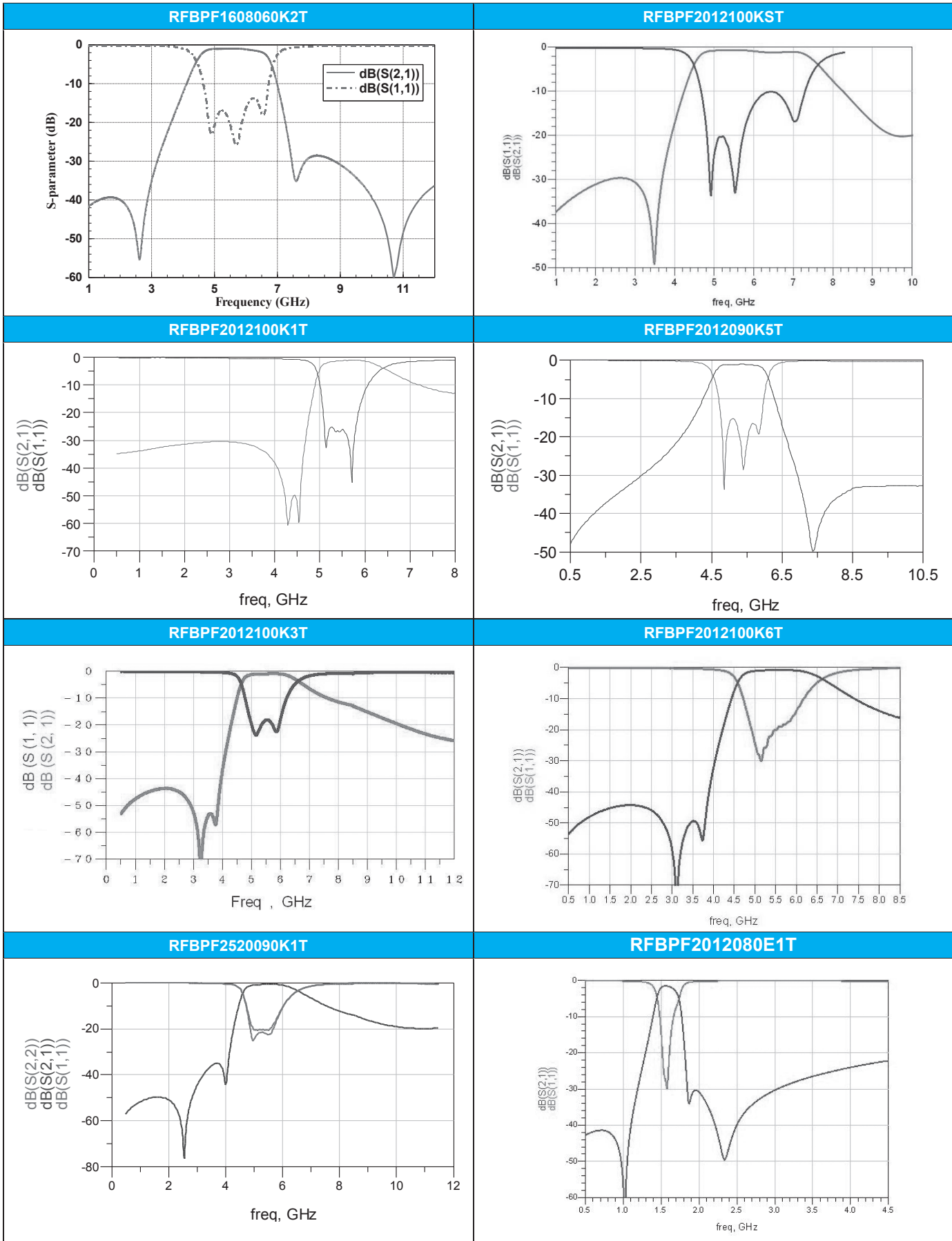

- For more information, please contact with local sales representative
- All specifications are subject to change without notice

HIGH FREQUENCY MULTILAYER BALANCED FILTER

■ STRUCTURE AND PIN ASSOCIATED

STRUCTURE A	
	<p>STRUCTURE A-1</p>
	<p>STRUCTURE A-2</p>
STRUCTURE B	

■ STRUCTURE AND DIMENSION

Unit:mm

Structure Dimension	L	W	T	A	B	C	D	E	F	G
A	1.60±0.15	0.80±0.15	0.60±0.10	0.175±0.15	0.25±0.15	0.25±0.15	0.50±0.15	0.20±0.15	0.20±0.15	0.30±0.15
	2.00±0.15	1.25±0.15	0.40±0.10	0.175±0.10	0.35±0.15	0.30±0.15	0.65±0.10	0.20±0.10	0.20±0.15	0.50±0.10
			0.50±0.10	0.20±0.15	0.30±0.15	0.35±0.15	0.65±0.15	0.20±0.15	0.20±0.15	0.30±0.15
			0.60±0.10	0.20±0.15	0.30±0.10	0.35±0.10	0.65±0.10	0.20±0.15	0.20±0.15	0.50±0.10
			0.90±0.10	0.20±0.15	0.30±0.10	0.35±0.10	0.65±0.10	0.20±0.15	0.20±0.15	0.30±0.10
			1.00±0.10	0.20±0.15	0.30±0.10	0.35±0.10	0.65±0.10	0.20±0.10	0.20±0.15	0.50±0.10
					0.50±0.10	0.35±0.10	0.65±0.10	0.20±0.15	0.20±0.15	0.55±0.10
	1.10±0.10	0.20±0.15	0.30±0.10	0.35±0.10	0.65±0.10	0.20±0.15	0.20±0.15	0.50±0.10		
2.50±0.20	2.00±0.20	0.85±0.10	0.35±0.20	0.40±0.10	0.30±0.10	0.70±0.20	0.15(Typical)	0.15(Typical)	1.20±0.20	
B	2.00±0.15	1.25±0.10	0.60±0.10	0.20±0.10	0.30±0.15	0.25±0.15	0.65±0.10	0.25±0.10	-	-

■ ELECTRICAL SPECIFICATION
■ 2.4GHz BAND WORKING FREQUENCY

Part Number	Frequency Range (MHz)	Impedance (Ω)		Insertion Loss (dB)	Attenuation (dB min.)	VSWR (Max.)	Size (mm)	STRUCTURE
		Unbalance	Balance					
RBBPB2012050A9T	2.4~2.5	50	Conjugate match to BC series of Bluetooth chipset	2.5	35(880~960 MHz) 15(1710~1880 MHz) 15(1880~1910 MHz) 25(4800~5000 MHz)	2.0	2.00x1.25x0.50	A-1
RFBBPB2012060A1T	2.4~2.5	50	Conjugate match to BC series of Bluetooth chipset	3.5	35(880~960MHz) 30(1710~1880MHz) 25(1880~1900MHz) 20(1900~1990MHz) 30(4800~5000MHz)	2.0	2.00x1.25x0.60	A-1
RFBBPB2012060AM1T61	2.4~2.5	50	Conjugate with MTK MT_6611 MT_6612 Bluetooth chipset	3.5	35(880~960 MHz) 30(1710~1880 MHz) 25(1880~1900 MHz) 20(1900~1990 MHz) 30(4800~5000 MHz)	2.0	2.00x1.25x0.60	A-1
RFBBPB2012090A1T	2.4~2.5	50	Conjugate match to BC series of Bluetooth chipset	3.5	35(880~960MHz) 30(1710~1880MHz) 20(1880~1990MHz) 30(4800~5000MHz)	2.1	2.00x1.25x0.90	A-1
RFBBPB2012090A2T	2.4~2.5	50	Conjugate match to MTK MT6611 series Bluetooth chipset	2.8	35(880~960 MHz) 30(1710~1880 MHz) 20(1880~1990 MHz) 30(4800~5000 MHz)	2.1	2.00x1.25x0.90	A-1
RFBBPB2012090A3T	2.4~2.5	50	Conjugate match to BC series of Bluetooth chipset	3.5	35(880~960 MHz) 30(1710~1880 MHz) 20(1880~1990 MHz) 30(4800~5000 MHz)	2.1	2.00x1.25x0.90	A-1
RFBBPB2012090A7T	2.4~2.5	50	Conjugate with chipset STLC25xx Series	2.8	35(880~960 MHz) 25(1710~1880 MHz) 15(1880~1990 MHz) 25(4800~5000 MHz) 20(7200~7500 MHz)	2.0	2.00x1.25x0.90	A-1
RFBBPB2012090A9T	2.4~2.5	50	Conjugate match to BC series of Bluetooth chipset	2.8	35(880~960MHz) 30(1575MHz) 25(1710~1880MHz) 30(4800~5000MHz)	2.1	2.00x1.25x0.90	A-1
RFBBPB2012090AAT	2.4~2.5	50	Conjugate match to CSR BC03/ 04 series	3.5	35(880~960 MHz) 30(1710~1880 MHz) 20(1880~1990 MHz) 30(4800~5000 MHz)	2.1	2.00x1.25x0.90	A-1
RFBBPB2012060ABT	2.4~2.5	50	Impedance match to T.I. CC253X, CC254X, CC257X, CC853X and CC852X Chipsets	1.5max.(25°C) 1.7max.(-40~+85°C)	12(1000 MHz) 15(4800~5000 MHz) 20(7200~7500 MHz)	2.0	2.00x1.25x0.60	B
RFBBPB2012090AHT	2.4~2.5	50	100	3.5	30(880~960MHz) 30(1710~1880MHz) 20(1880~1990MHz) 30(4800~5000MHz)	2.0	2.00x1.25x0.90	A-1
RFBBPB2012090AM1T59	2.4~2.5	50	Conjunction to MT5931/ MT6628 Chipset	2.5 (typ.2.2)	35(824~960 MHz) 32(1990 MHz) 18(2170 MHz) 40(4800~5000MHz) 25(7200~7500MHz)	2.0	2.00x1.25x0.95	A-1
RFBBPB2012090AM1T61	2.4~2.5	50	Conjugate match to MTK MT6611 Bluetooth chipset	2.8	35(880~960MHz) 30(1710~1880MHz) 20(1880~1900MHz) 30(4800~5000MHz)	2.1	2.00x1.25x0.90	A-1
RFBBPB2012100A6T	2.4~2.5	50	Conjugate match to BC series of Bluetooth chipset	3.5	35(880~960MHz) 30(1710~1880MHz) 20(1880~1900MHz) 40(4800~5000MHz)	2.0	2.00x1.25x1.00	A-1
RFBBPB2012110A5T	2.4~2.5	50	50	2.8	30(880~960 MHz) 30(1710~1880 MHz) 20(1880~1990 MHz) 30(4800~5000 MHz)	2.0	2.00x1.25x1.10	A-1
RFBBPB2520090A7T	2.4~2.5	50	Conjugate match to TI BRF6150	3.5	35(880~960MHz) 30(1710~1880MHz) 25(1880~1990MHz) 25(4800~5000MHz)	2.0	2.50x2.00x0.90	A-2

HIGH FREQUENCY MULTILAYER BALANCED FILTER

■ TYPICAL ELECTRICAL CHARACTERISTICS

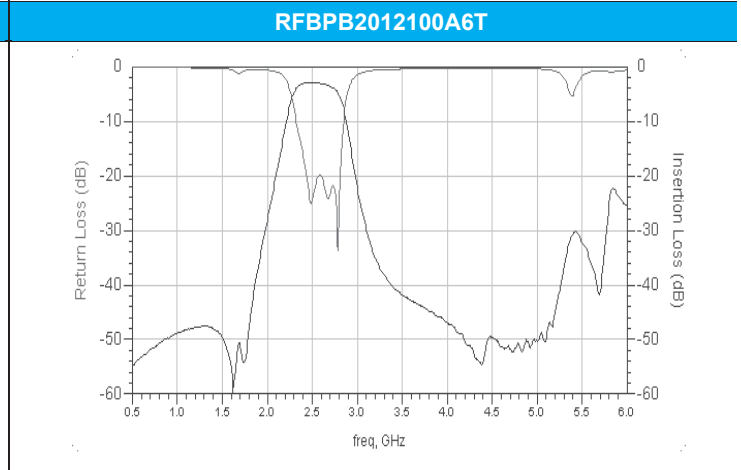
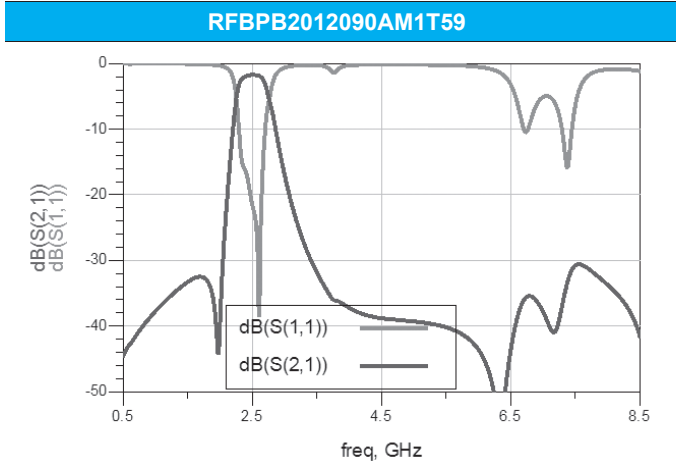
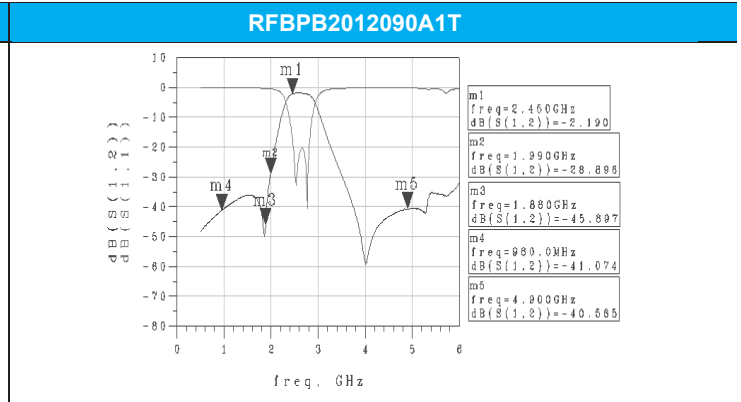
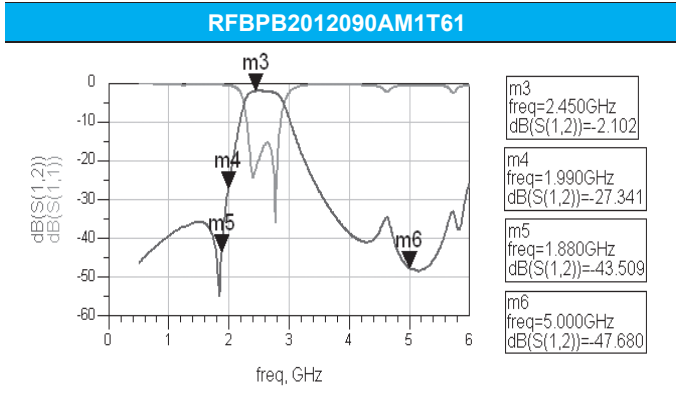

■ For more information, please contact with local sales representative

■ All specifications are subject to change without notice

■ STRUCTURE AND PIN ASSOCIATED

STRUCTURE A				
	<p>STRUCTURE A-1</p>	<p>STRUCTURE A-2</p>	<p>STRUCTURE A-3</p>	
	STRUCTURE B			
		<p>STRUCTURE B-1</p>	<p>STRUCTURE B-2</p>	
STRUCTURE C		STRUCTURE D		
	STRUCTURE E		STRUCTURE F	

HIGH FREQUENCY MULTILAYER LOW PASS FILTER

■ STRUCTURE AND DIMENSION

Unit:mm

Structure Dimension	L	W	T	A	B	C	D	E	F
A	1.60±0.10	0.80±0.10	0.60±0.10	0.20±0.10	0.24±0.10	0.24±0.10	0.50±0.10	0.15±0.10	-
	1.60±0.15	0.80±0.15		0.175±0.15	0.25±0.15	0.25±0.15	0.50±0.15	0.20±0.15	-
B	2.00±0.10	1.25±0.10	0.90±0.10	0.20±0.10	0.30±0.10	0.35±0.10	0.65±0.10	0.20±0.10	0.20±0.10
	2.00±0.15		1.05±0.10	0.20±0.10	0.30±0.10	0.35±0.10	0.65±0.10	0.20±0.10	0.20±0.10
C	1.00±0.10	0.50±0.10	0.40±0.10	0.35±0.10	0.30±0.10	0.15±0.10	0.15±0.10	0.30±0.10	-
	1.60±0.15	0.80±0.15	0.50max.	0.45±0.15	0.70±0.15	0.20±0.15	0.20±0.15	0.30±0.15	0.25±0.15
D	0.65±0.10	0.50±0.10	0.40max.	0.20±0.05	0.20±0.05	0.025±0.025	0.10±0.05	0.25±0.05	0.025±0.025
E	1.60±0.15	0.80±0.15	0.45max	0.23±0.05	0.40±0.10	0.30±0.10	0.65±0.10	0.20±0.05	0.23±0.05
F	1.60±0.10	0.80±0.10	0.65max	0.60±0.10	0.25±0.10	0.25±0.10	0.40±0.10	0.10±0.05	0.10±0.05
	2.00±0.15	1.25±0.10	0.90±0.10	0.95±0.10	0.275±0.10	0.25±0.10	0.60±0.10	0.175±0.10	0.15±0.10

■ ELECTRICAL SPECIFICATION

■ GSM850/900GHz BAND WORKING FREQUENCY

Part Number	Frequency Range (MHz)	Insertion Loss (dB)	Attenuation (dB min.)	VSWR (max.)	Impedance (Ω)	Size (mm)	Structure
RFLPF06050G9D0T	824~915	0.5max.(25°C) 0.7max.(-40~+85°C)	20(2400~2750MHz)	2.0	50	0.65x0.50x0.40	D
RFLPF10050G9D0T	824~915	0.6	25(1648~1830MHz) 25(2472~2745MHz) 25(3296~3660MHz)	2.0	50	1.00x0.50x0.40	C
RFLPF10050G9D3T	824~915	0.5max.(25°C) 0.7max.(-40~+85°C)	25(1648~1830MHz) 25(2472~2745MHz) 25(3296~3660MHz)	2.0	50	1.00x0.50x0.40	C
RFLPF10050G9D4T	699~915	0.5max.(25°C) 0.7max.(-40~+85°C)	25(1648~1830MHz) 25(2472~2745MHz) 25(3296~3660MHz)	2.0	50	1.00x0.50x0.40	C
RFLPF16080G9D1T	824~915	0.45	25(1648~1830MHz) 25(2472~2745MHz) 25(3296~3660MHz)	2.0	50	1.60x0.80x0.50	C
RFLPF16080G9D4T	698~960	0.60(698~830MHz) 0.70(830~900MHz) 0.75(900~915MHz) 0.90(915~960MHz)	30(1554~1830MHz) 35(2097~2745MHz)	1.6	50	1.60x0.80x0.65	A-3

■ DCS/PCS BAND WORKING FREQUENCY

Part Number	Frequency Range (MHz)	Insertion Loss (dB)	Attenuation (dB min.)	VSWR (max.)	Impedance (Ω)	Size(mm)	Structure
RFLPF10051G8D0T	1710~1910	0.8	35(3420~3570MHz) 35(3700~3820MHz) 35(5130~5730MHz)	2.0	50	1.00x0.50x0.40	C
RFLPF10051G8D4T	1710~1980	0.8max.(25°C) 1.0max.(-40~+85°C)	17(2400~2500MHz)	2.0	50	1.00x0.50x0.40	C
RFLPF10051G8D5T	1800~2025	0.8max.(25°C) 1.0max.(-40~+85°C)	17(2400~2500MHz)	2.0	50	1.00x0.50x0.40	C
RFLPF10051G8DM5T51	1710~1910	0.6	26(3420~3570MHz) 21(3700~3820MHz) 21(5130~5730MHz)	2.0	50	1.00x0.50x0.40	C
RFLPF10051G8DM0T26	1800~2025	0.8max.(25°C) 1.0max.(-40~+85°C)	17(2400~2500MHz)	2.0	50	1.00x0.50x0.40	C
RFLPF16081G8D1T	1710~1910	0.4	30(3420~3570MHz) 25(3700~3820MHz) 25(5130~5730MHz)	2.0	50	1.60x0.80x0.50	C
RFLPF16081G8D3T	1710~1910	0.45max.(25°C) 0.55max.(-40~+85°C)	30(3420~3570MHz) 25(3700~3820MHz) 25(5130~5730MHz)	2.0	50	1.60x0.80x0.50	C

■ TD-SCDMA BAND WORKING FREQUENCY

Part Number	Frequency Range (MHz)	Insertion Loss (dB)	Attenuation (dB min.)	VSWR (max.)	Impedance (Ω)	Size(mm)	Structure
RFLPF1005040Z0T	f1: 2017.5±7.5 f2: 1900± 20	0.50	24(2x f1 MHz) 16(3x f1 MHz) 17(2x f2 MHz) 16(3x f2 MHz)	2.0	50	1.00x0.50x0.40	C

■ 2.4GHz BAND WORKING FREQUENCY

Part Number	Frequency Range (MHz)	Insertion Loss (dB)	Attenuation (dB min.)	VSWR (max.)	Impedance (Ω)	Size (mm)	Structure
RFLPF1005040A0T	2450±50	0.45max.(25°C) 0.55max.(-40~+85°C)	21(4800- 5000MHz) 21(7200- 7500MHz)	1.7	50	1.00x0.50x0.40	C
RFLPF1005040A1T	2450±50	0.75	33(4800~ 5000MHz) 37(7200~ 7500MHz)	2.0	50	1.00x0.50x0.40	C
RFLPF1005040A2T	2450±50	0.75max.(25°C) 0.90max.(-40~+85°C)	32(4800~5000MHz) 35(7200~7500MHz)	2.0	50	1.00x0.50x0.40	C
RFLPF1608060A0T	2450±50	0.65 (typ.0.48)	35(4800 MHz (typ. 40)) 27(7200 MHz (typ. 40))	1.5	50	1.60x0.80x0.60	A-1
RFLPF1608060A1T	2450±50	0.6	27(4800~5000 MHz) 30(7200~7500 MHz)	2.0	50	1.60x0.80x0.60	A-2
RFLPF1608060A2T	2450±50	0.42	25(4800 MHz) 18(7200 MHz)	1.5	50	1.60x0.80x0.60	A-1
RFLPF1608040A7T	2450±50	0.45	35(4800~5000MHz) 35(7200~7500MHz)	1.6	50	1.60x0.80x0.40	E
RFLPF2012110A0T	2450±50	0.7	30(2x(fo±BW/2)) 20(3x(fo±BW/2))	1.5	50	2.00x1.25x1.05	B

■ 5GHz BAND WORKING FREQUENCY

Part Number	Frequency Range (MHz)	Insertion Loss (dB)	Attenuation (dB min.)	VSWR (max.)	Impedance (Ω)	Size(mm)	Structure
RFLPF1608050K0T	5400 ± 500	0.60	25(9800 MHz) 30(11900 MHz) 20(17850 MHz) (for reference)	2.0	50	1.60x0.85x0.50	C
RFLPF2012090K0T	5400 ± 500	0.55(25°C) 0.65(-40~+85°C)	30(9800 MHz) 30(11800 MHz) 20(17550 MHz) (for reference)	2.0	50	2.00x1.25x0.90	B

■ LTE BAND APPLICATION

Part Number	Frequency Range (MHz)	Insertion Loss (dB)	Attenuation (dB min.)	VSWR (max.)	Impedance (Ω)	Size(mm)	Structure
RFLPF1608060Y08Q1C	470~787	0.65(25°C) 0.71(-40~+85°C)	26(1429~1501MHz) 30(1565~1607MHz) 35(1570~1580MHz) 18(1920~1980MHz)	2.0	50	1.60x0.85x0.65	A-3
RFLPF1608060F0T	600~2700	0.50	30(4800~8000MHz) 25(8500~12500MHz)	2.0	50	1.60x0.85x0.65	F
RFLPF1608060F18Q1C	673~2690	0.50	35(4950~6000MHz) 35(6000~7500MHz) 35(7500~8100MHz) 35(8100~10500MHz) 27(10500~12500MHz)	2.0	50	1.60x0.85x0.65	F
RFLPF1608060Y18Q1C	698~960	0.60(698~830MHz) 0.70(830~900MHz) 0.75(900~915MHz) 0.90(915~960MHz)	30(1554~1830MHz) 35(2097~2745MHz)	1.6	50	1.60x0.85x0.65	A-3

HIGH FREQUENCY MULTILAYER LOW PASS FILTER

LET BAND APPLICATION

Part Number	Frequency Range (MHz)	Insertion Loss (dB)	Attenuation (dB min.)	VSWR (max.)	Impedance (Ω)	Size(mm)	Structure
RFLPF16082G6W0T	2400~2690	0.6	26(4800~5390MHz) 23(7200~8085MHz)	2.0	50	1.60x0.80x0.60	A-2
RFLPF16082G6W2T	2300~2700	0.40max.(25°C) 0.43max.(-40~+85°C)	21(4600~5400MHz) 22(6900~8100MHz)	2.0	50	1.60x0.80x0.60	A-2
RFLPF16082G5W0T	2300~2700	0.90max.(25°C) 1.00max.(-40~+85°C)	30(4600~5400MHz) 30(6900~8100MHz) 20(9200~10800MHz) 15(11500~13500MHz)	1.8	50	1.60x0.80x0.60	A-1
RFLPF16082G5WM0T29	2300~2690	0.80 (typ.0.40)	25(4600~5400MHz) 25(6900~8070MHz)	2.0	50	1.60x0.80x0.60	A-1
RFLPF16083G5W7T	3300~3800	0.55	17(6600~7600MHz) 20(9900~11400MHz)	1.9	50	1.60x0.80x0.60	A-3
RFLPF2012100F18Q1C	1710~2170	1.30max.(25°C) 1.50max.(-40~+85°C)	15(2400~2500MHz) 25(3250~3350MHz) 25(3420~3570MHz) 23(3700~3820MHz) 23(3840~3960MHz) 23(4100~4600MHz) 25(4905~5845MHz) 23(5850~6400MHz) 20(6600~7350MHz)	1.56	50	2.00x1.25x1.00	B-2
RFLPF2012090BM0T29	800~1000 1700~1910 2010~2025	0.5(800~1000MHz) 0.8(1700~1910MHz) 1.5(2010~2025MHz)	20(2300~3700MHz) 30(3700~4100MHz) 20(4100~6100MHz) 10(6100~8000MHz)	2.0	50	2.00x1.25x0.90	F

TYPICAL ELECTRICAL CHARACTERISTICS

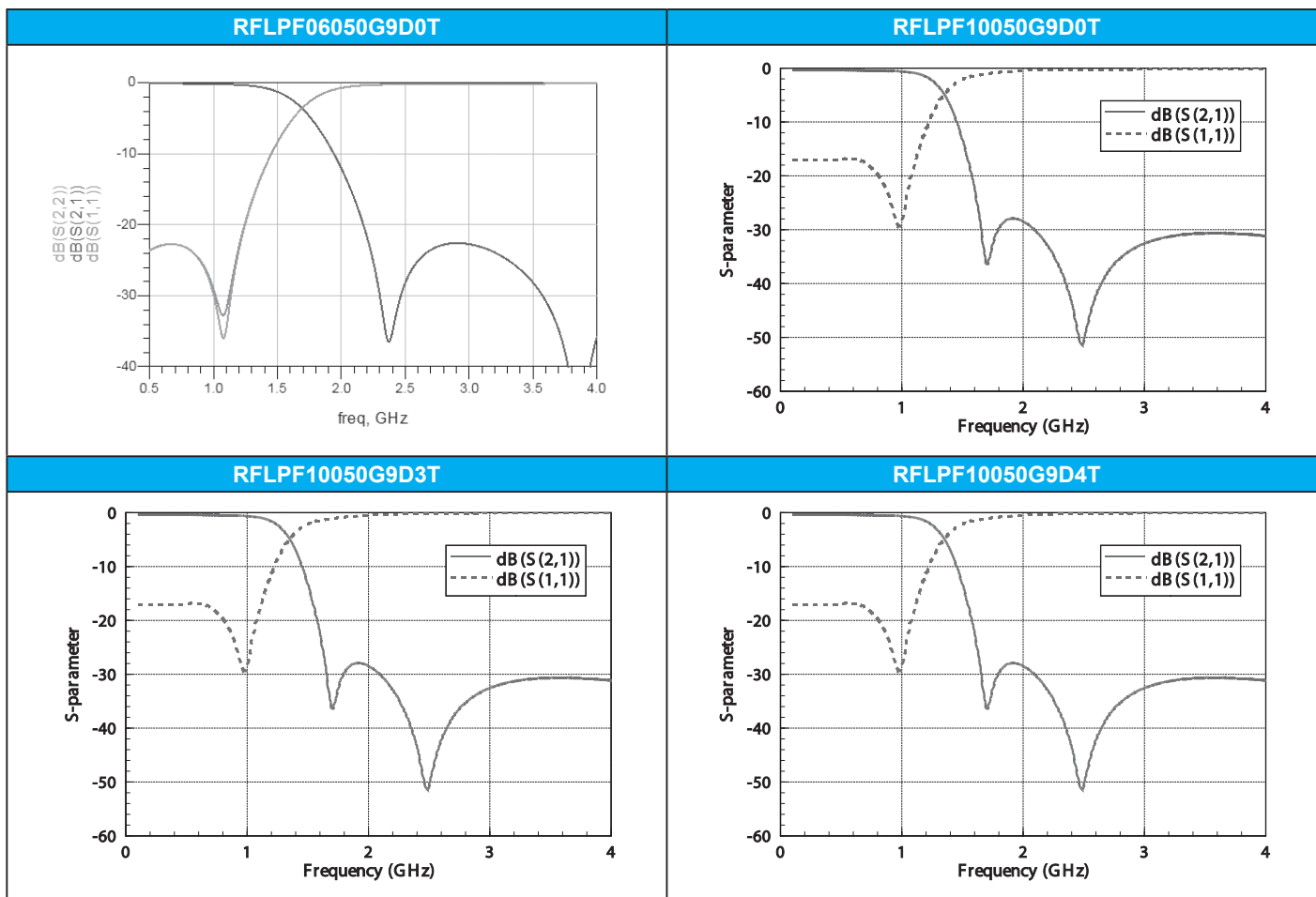

HIGH FREQUENCY MULTILAYER LOW PASS FILTER

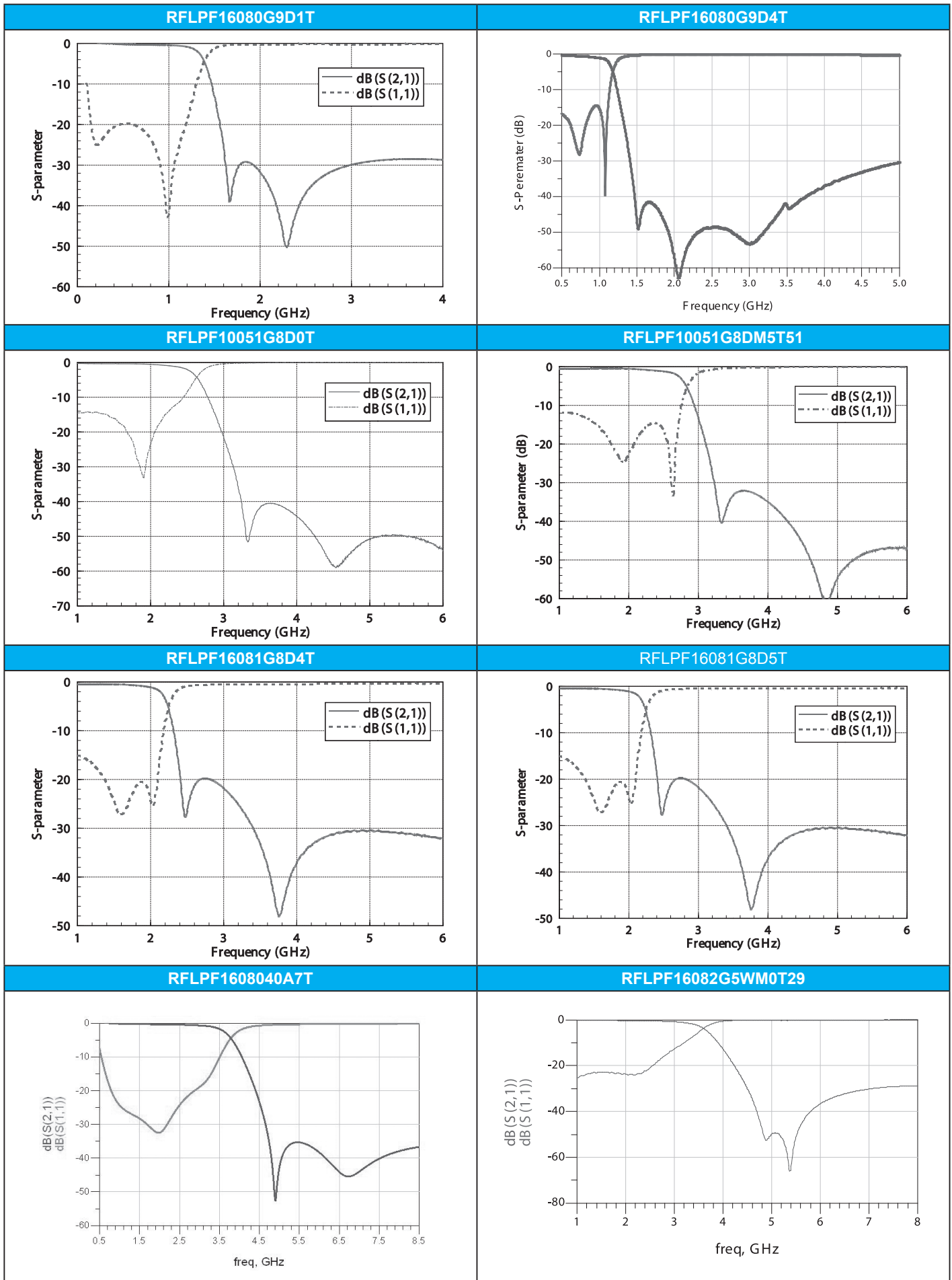

HIGH FREQUENCY MULTILAYER LOW PASS FILTER

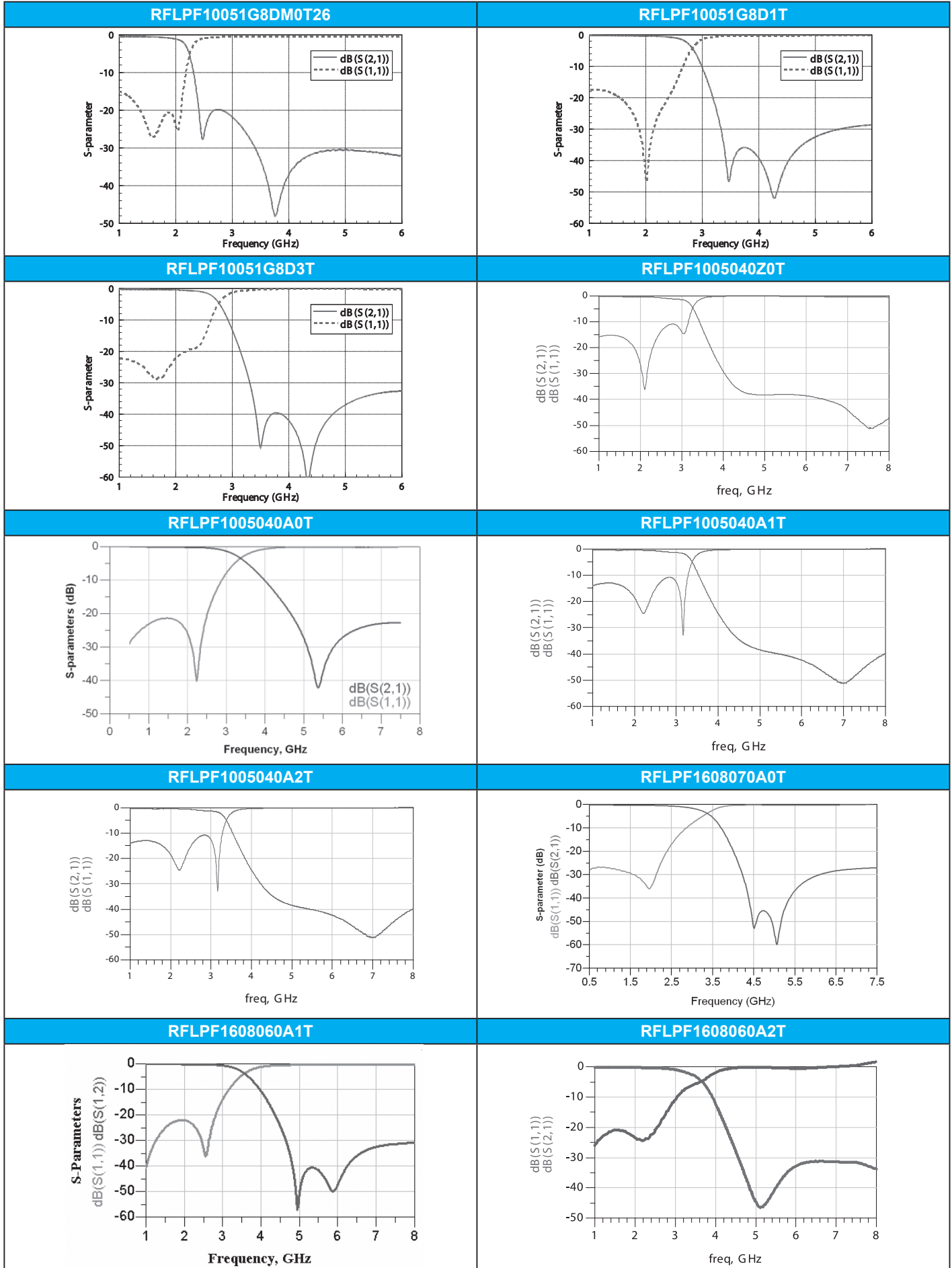

HIGH FREQUENCY MULTILAYER LOW PASS FILTER

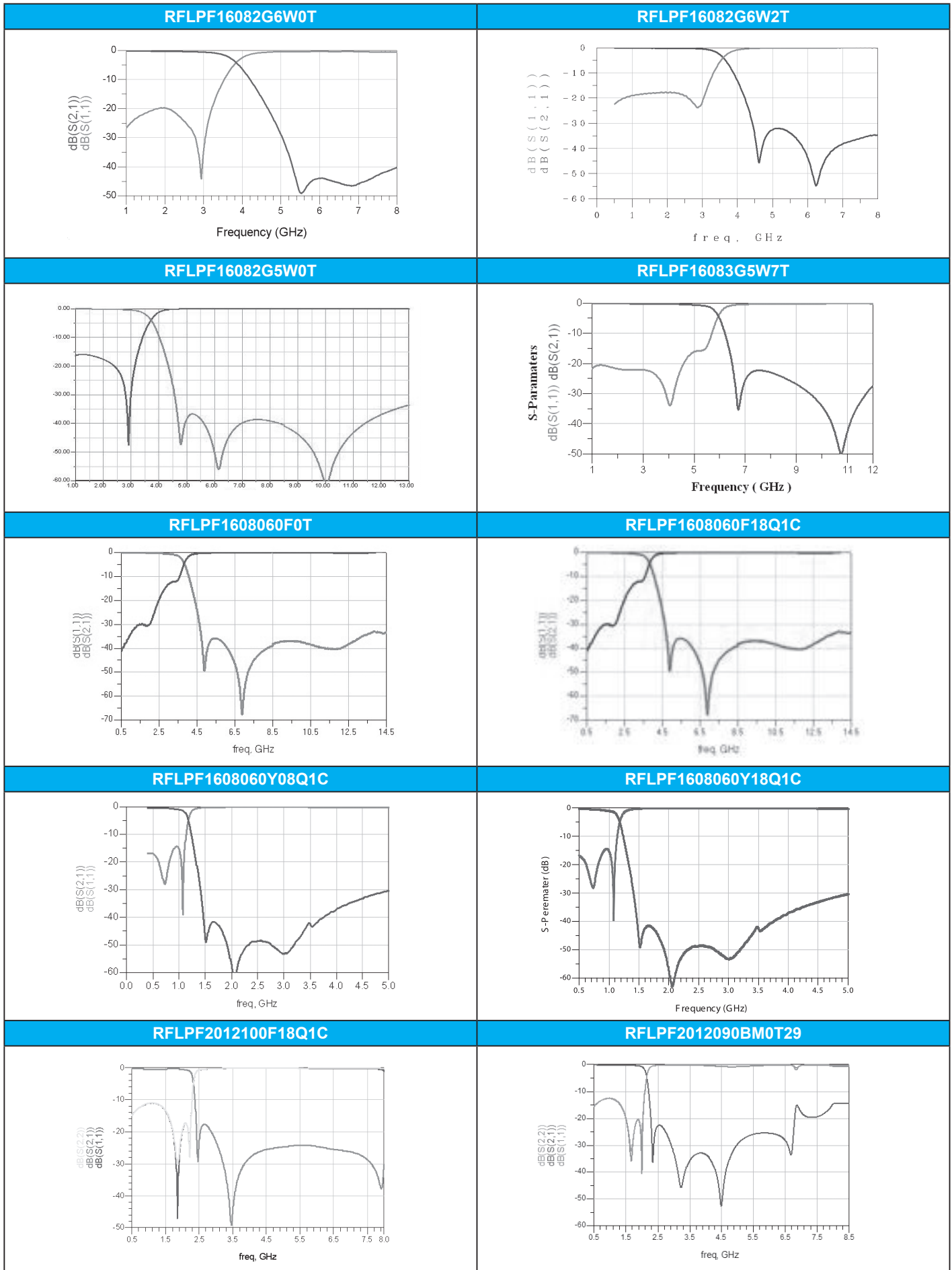

- For more information, please contact with local sales representative
- All specifications are subject to change without notice

HIGH FREQUENCY MULTILAYER HIGH PASS FILTER

■ STRUCTURE AND PIN ASSOCIATED

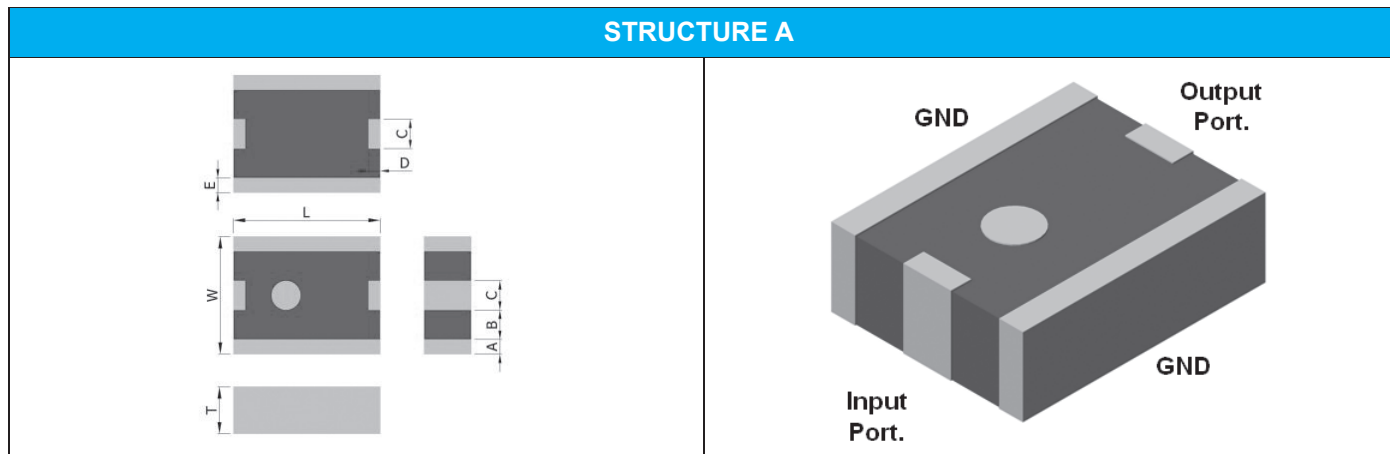

■ STRUCTURE AND DIMENSION

Unit:mm

Structure Dimension	L	W	T	A	B	C	D	E
A	2.50 ± 0.2	2.00 ± 0.2	0.90 ± 0.1.	0.20 ± 0.2	0.55 ± 0.2	0.50 ± 0.2	0.20 ± 0.2	0.20 ± 0.2

■ ELECTRICAL SPECIFICATION

■ ISM 2.4/ 5GHz Band Application

Part Number	Frequency Range (MHz)	Insertion Loss (dB)	Attenuation (dB min.)	VSWR (max.)	Size (mm)	Structure
RFHFPF2520090LOT	2400~2500	2.0max.(25°C) 2.3max.(-40~+85°C)	30(869~960 MHz) 45(1805~1990 MHz)	2	2.50x2.00x0.90	A
	5150~5825	1.3max.(25°C) 1.6max.(-40~+85°C)	30(869~960 MHz) 45(1805~1990 MHz)	2		

■ TYPICAL ELECTRICAL CHARACTERISTICS

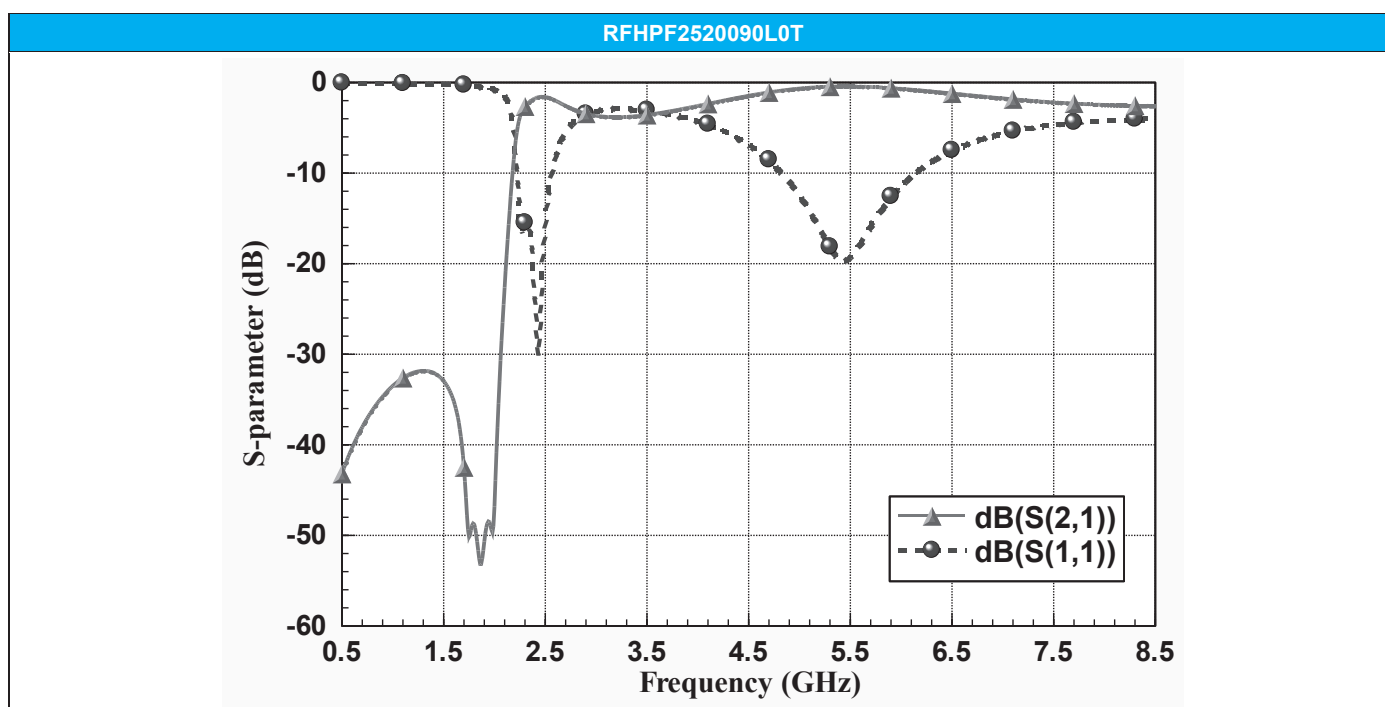

■ STRUCTURE AND PIN ASSOCIATED

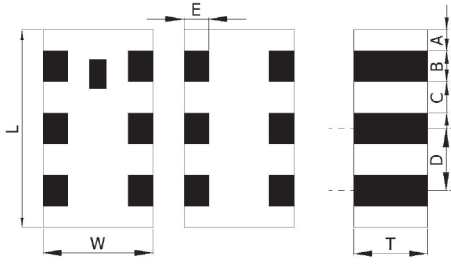
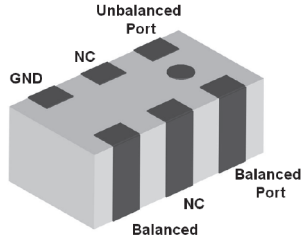
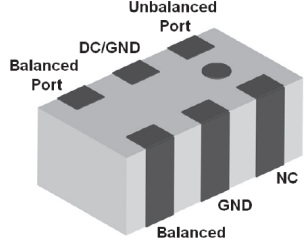
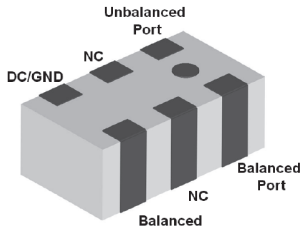
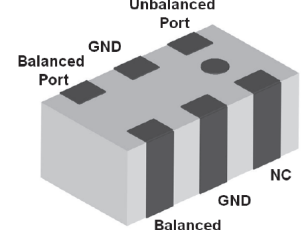
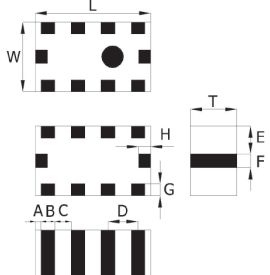
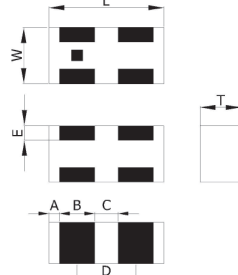
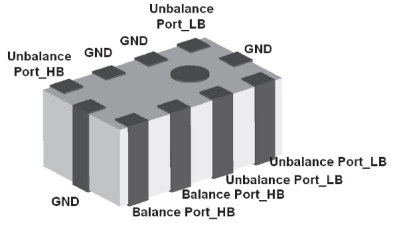
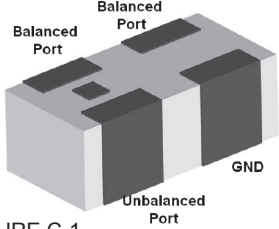
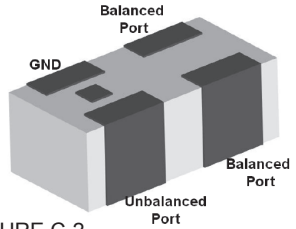
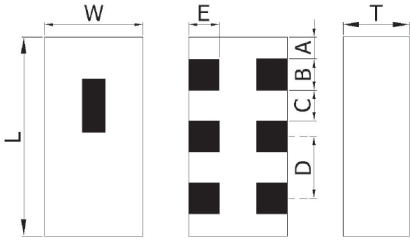
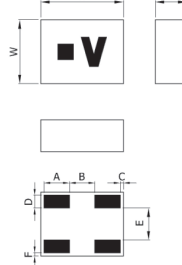
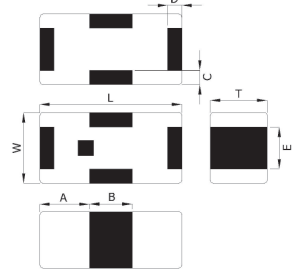
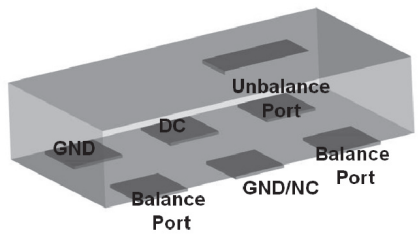
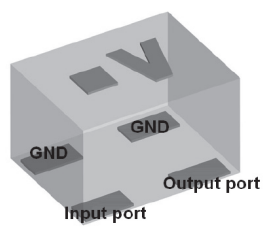
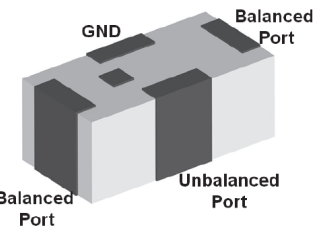
STRUCTURE A					
	 <p>STRUCTURE A-1</p>	 <p>STRUCTURE A-2</p>			
	 <p>STRUCTURE A-3</p>	 <p>STRUCTURE A-4</p>			
	STRUCTURE B		STRUCTURE C		
					
	 <p>STRUCTURE C-1</p>	 <p>STRUCTURE C-2</p>			
STRUCTURE D		STRUCTURE E		STRUCTURE F	
					
					

■ STRUCTURE AND DIMENSION

Unit:mm

Structure\ Dimension	L	W	T	A	B	C	D	E	F	G	H	
A	1.60±0.10	0.85±0.10	0.70±0.10	0.20±0.10	0.20±0.10	0.30±0.10	0.50±0.05	0.50±0.05	-	-	-	
	1.60±0.15	0.80±0.10	0.50±0.10	0.175±0.15	0.25±0.15	0.25±0.15	0.50±0.15	0.20±0.15	-	-	-	
			0.40 max.	0.175±0.15	0.25±0.15	0.25±0.15	0.50±0.15	0.20±0.15	-	-	-	
		0.85±0.10	0.60±0.10	0.175±0.15	0.25±0.15	0.25±0.15	0.50±0.15	0.20±0.15	-	-	-	
	2.00±0.15	1.25±0.15	0.85±0.15	0.70±0.10	0.175±0.15	0.25±0.15	0.25±0.15	0.50±0.15	-	-	-	-
				0.65±0.10					-	-	-	-
			0.80±0.10	0.20±0.20	0.30±0.20	0.35±0.20	0.65±0.20	-	-	-	-	
			0.85±0.10	0.20±0.20	0.30±0.20	0.35±0.20	0.65±0.20	-	-	-	-	
	2.00±0.15	1.25±0.15	0.80±0.10	0.20±0.15	0.30±0.20	0.35±0.20	0.65±0.20	-	-	-	-	
			0.95±0.10	0.20±0.20	0.30±0.20	0.35±0.20	0.65±0.20	-	-	-	-	
B	2.00±0.10	1.25±0.15	0.90±0.10	0.125±0.10	0.25±0.10	0.25±0.10	0.50±0.10	0.475±0.10	0.30±0.10	0.20±0.15	0.20±0.15	
C	1.00±0.10	0.50±0.10	0.37±0.10	0.10±0.10	0.30±0.10	0.20±0.10	0.50±0.10	0.125±0.10	-	-	-	
	1.00±0.10	0.50±0.10	0.40±0.10	0.10±0.10	0.30±0.10	0.20±0.10	0.50±0.10	0.125±0.10	-	-	-	
D	1.60±0.15	0.80±0.15	0.50±0.10	0.175±0.10	0.25±0.10	0.25±0.10	0.50±0.10	0.25±0.10	-	-	-	
E	0.65±0.10	0.50±0.10	0.40±0.10	0.20±0.05	0.20±0.05	0.025±0.025	0.10±0.05	0.25±0.05	0.025±0.025	-	-	
F	1.00±0.10	0.50±0.10	0.5 max.	0.35±0.10	0.30±0.10	0.15±0.10	0.15±0.10	0.30±0.10	-	-	-	

■ ELECTRICAL SPECIFICATION

■ ISM Band 2.4GHz Application

Part Number	Frequency Range (MHz)	Impedance(Ω)		Return Loss (dB)Min.	Insertion Loss (dB)	Amplitude Difference (dB)Max.	Size (mm)	Structure
		Unbalance	Balance					
RFBLN1005040A3T	2450±50	50	Conjugate match to AR6003 chipset	10	1.4	2.0	1.00x0.50x0.40	C-1
RFBLN1608050AAT	2450±50	50	Conjugate match to AR6003 chipset	-	1.2	2.0	1.60x0.80x0.50	D
RFBLN1608060AM1T59	2450±50	50	200	10	1.2	2.0	1.60x0.80x0.65	A-3
RFBLN1608050AM8T62	2450±50	50	50	10	1.2	2.0	1.60x0.80x0.50	A-2
RFBLN1608050AM0T63	2450±50	50	50	10	1.0	1.0	1.60x0.80x0.55	A-2
RGBLN1608070A1T	2450±50	50	100	10	1.5	2.0	1.60x0.85x0.70	A-1
RFBLN1608070A3T	2450±50	50	100	10	1.0	2.0	1.60x0.85x0.70	A-1
RFBLN1608070A4T	2450±50	50	100	10	1.0	2.0	1.60x0.80x0.70	A-1
RGBLN1608070A5T	2450±50	50	100	10	1.2	2.0	1.60x0.80x0.70	A-2
RGBLN2012080A4T	2450±50	50	50	10	1.5	2.0	2.00x1.25x0.80	A-2
RGBLN2012080A5T	2450±50	50	50	12	1.0	1.0	2.00x1.25x0.85	A-2
RGBLN2012080A6T	2450±50	50	100	20	1.0	2.0	2.00x1.25x0.85	A-2
RFBLN2012080A7T	2450±50	50	100	10	1.0	2.0	2.00x1.25x0.80	A-2
RGBLN2012090A0T	2450±50	50	50	10	1.2	2.0	2.00x1.25x0.95	A-2
RFBLN2012090A1T	2.4GHz	50	100	10	1.0	2.0	2.00x1.25x0.95	A-2
RFBLN2012090A2T	2.4GHz	50	200	10	1.0	2.0	2.00x1.25x0.95	A-2

■ ISM Band 5GHz Application

Part Number	Frequency Range (GHz)	Impedance(Ω)		Return Loss (dB)Min.	Insertion Loss (dB)	Amplitude Difference (dB)Max.	Size (mm)	Structure
		Unbalance	Balance					
RFBLN2012090K0T	4.9 / 5.2 / 5.8	50	50	10	1.1	2.0	2.00x1.25x0.95	A-4
RFBLN2012090K1T	4.9 / 5.2 / 5.8	50	100	10	1.2	2.0	2.00x1.25x0.95	A-4

■ LTE BAND APPLICATION

Part Number	Frequency Range (MHz)	Impedance(Ω)		Return Loss (dB)Min.	Insertion Loss (dB)	Amplitude Difference (dB)Max.	Size(mm)	Structure
		Unbalance	Balance					
RFBLN1005040YM1T69	703~803	50	100	10	0.80	2.0	1.00x0.50x0.40	F
RFBLN16080G9D2T	699~960	50	100	10	1.05(25°C) 1.15(-40~+85°C)	2.5	1.60x0.80x0.70	A-4
RFBLN10051G9D0T	1850~2020	50	100	10	0.65(25°C) 0.75(-40~+85°C)	2.0	1.00x0.50x0.40	C-2
RFBLN10051G9D1T	1850~1990	50	100	10	0.60(25°C) 0.70(-40~+85°C)	2.2	1.00x0.50x0.40	C-2
RFBLN06052G5WM9T16	2300~2690	50	100	10	0.55(25°C) 0.65(-40~+85°C)	2.5	0.65x0.50x0.40	E
RFBLN10052G5WM9T16	2300~2690	50	100	10	0.55(25°C) 0.65(-40~+85°C)	2.5	1.00x0.50x0.40	C-1
RFBLN10052G5W37N2T	2300~2690	50	100	10	0.65(25°C) 0.75(-40~+85°C)	2.5	1.00x0.50x0.40	C-2
RFBLN16082G5W0T	2300~2700	50	100	10	1.1	2.0	1.60x0.80x0.70	A-2
RFBLN16082G5W38Q1C	2300~2700	50	100	10	0.55(25°C) 0.65(-40~+85°C)	1.0	1.60x0.80x0.40	A-4

■ GSM 850/ GSM 900/ DCS1800/ PCS1900 Application

Part Number	Frequency Range (MHz)	Unbalance	Balance	Return Loss (dB) Min	Insertion Loss (dB)	Amplitude Difference (dB)Max	Attenuation (dB min.)	Size (mm)	Structure
RFBLN2012090BM3T25	869~960	50	200	10	1.0	2.0	10(1738~1920 MHz) 20(2607~2880 MHz)	2.00x1.25x0.90	B
	1805~1990	50	200	10	1.0	2.0	15(3610~3980 MHz) 15(5415~5970 MHz)		
RFBLN2012090BM5T25	869~960	50	200	10	1.1	2.0	10(1738~1920MHz) 20(2400~2500MHz) 20(2607~2880MHz)	2.00x1.25x0.95	B
	1805~2025	50	200	10	1.8	2.0	15(2400~2500MHz) 20(3610~3980MHz) 20(5415~5970MHz)		
RFBLN2012090BS0T53	869~960	50	200	10	1.1(25°C) 1.3(-40~+85°C)	2.0	10(1738~1920MHz) 20(2400~2500MHz) 20(2607~2880MHz)	2.00x1.25x0.95	B
	1805~1990	50	200	10	1.6(25°C) 1.8(-40~+85°C)	2.0	15(2400~2500MHz) 15(3610~3980MHz) 20(5415~5970MHz)		
RFBLN2012090BS0T62	869~960	50	200	10	1.1(25°C) 1.3(-40~+85°C)	2.0	10(1738~1920MHz) 20(2400~2500MHz) 20(2607~2880MHz)	2.00x1.25x0.95	B
	1805~2025	50	200	10	1.8(25°C) 2.0(-40~+85°C)	2.0	15(2400~2500MHz) 15(3610~3980MHz) 20(5415~5970MHz)		

■ TYPICAL ELECTRICAL CHARACTERISTICS

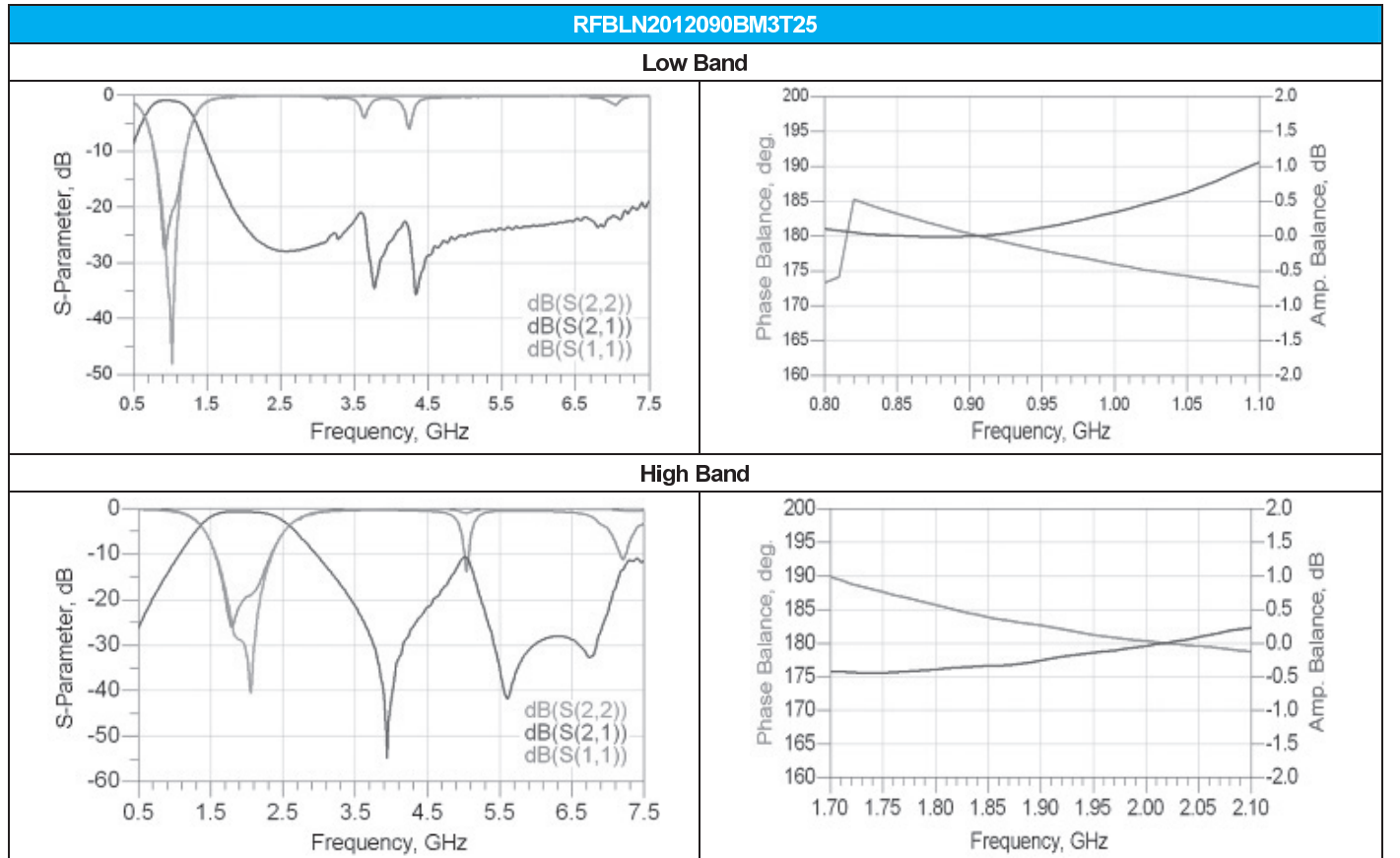

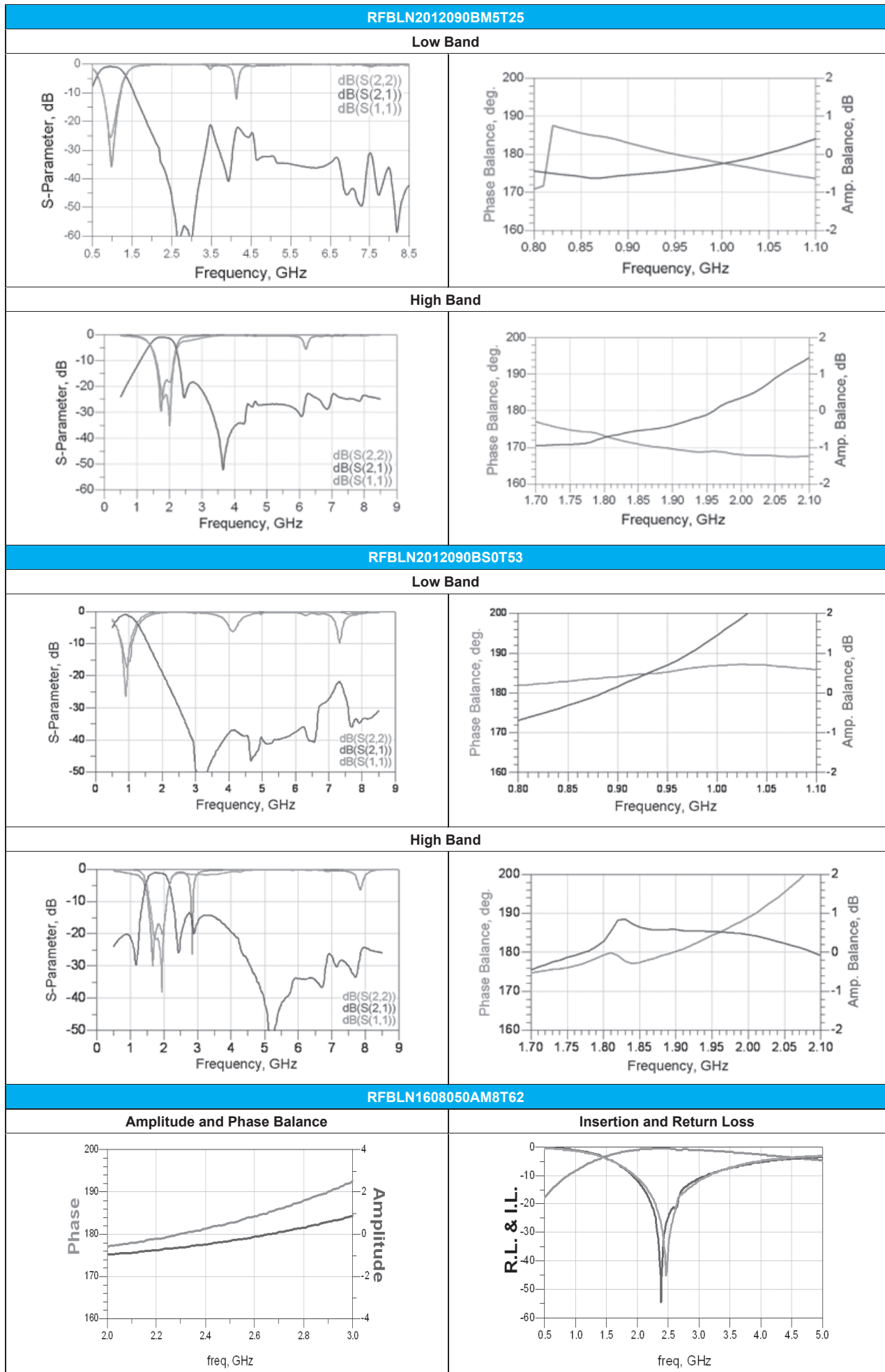

TYPICAL ELECTRICAL CHARACTERISTICS

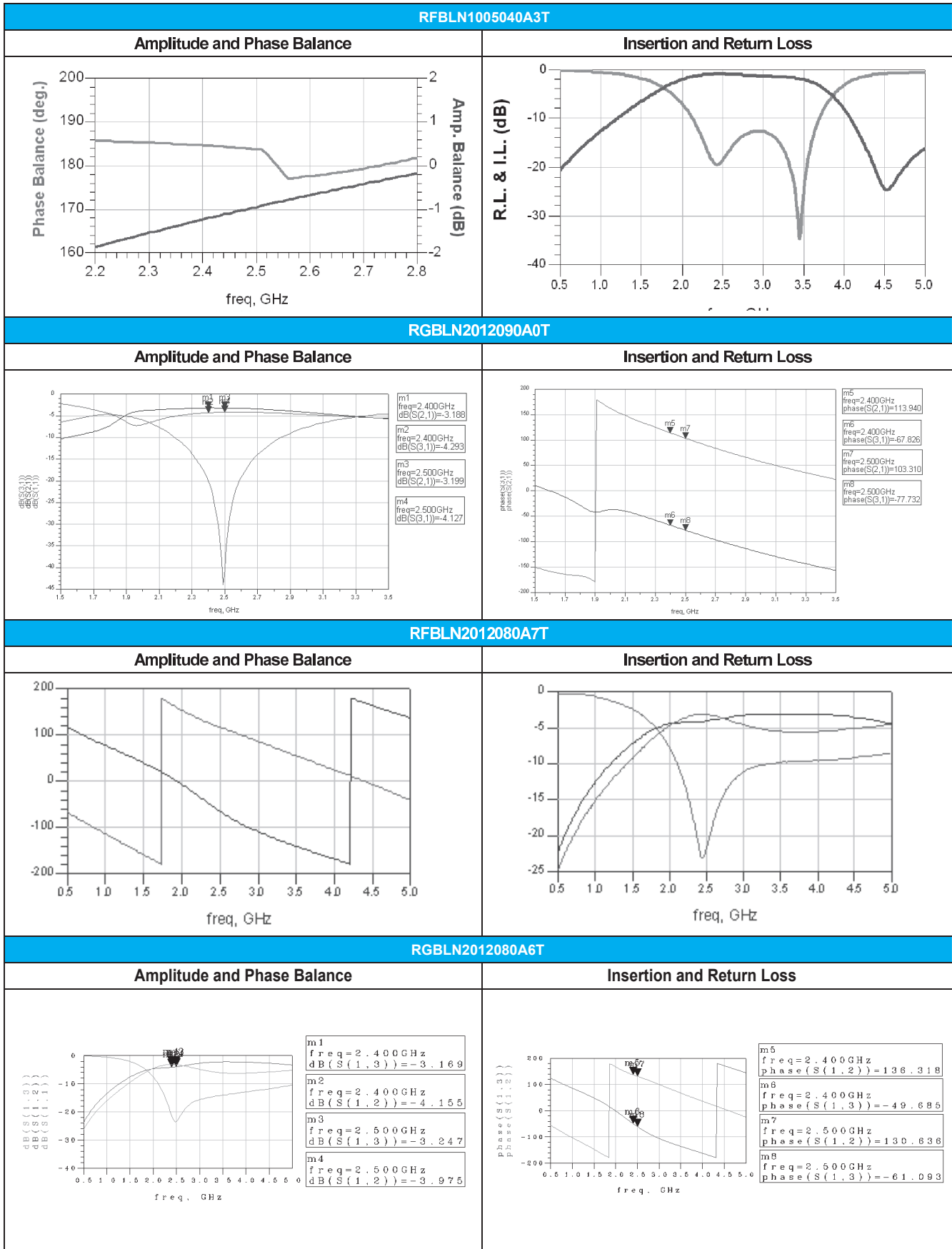

RFBLN1608060AM1T59

Amplitude and Phase Balance

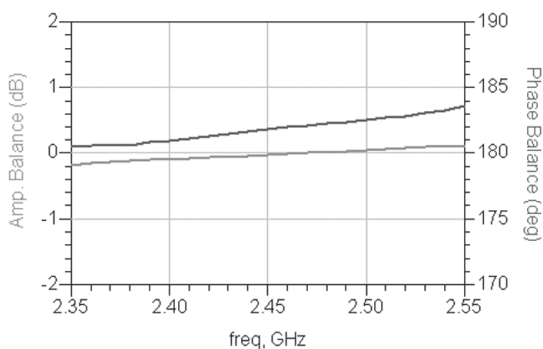

Insertion and Return Loss

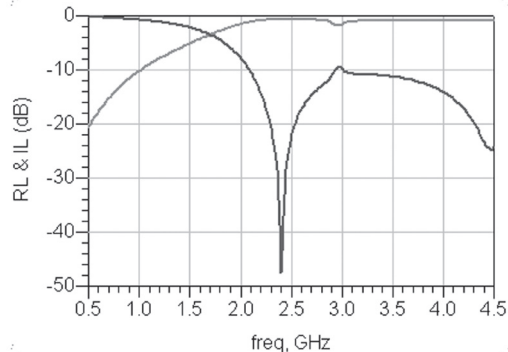

RFBLN1608050AM0T63

Amplitude and Phase Balance

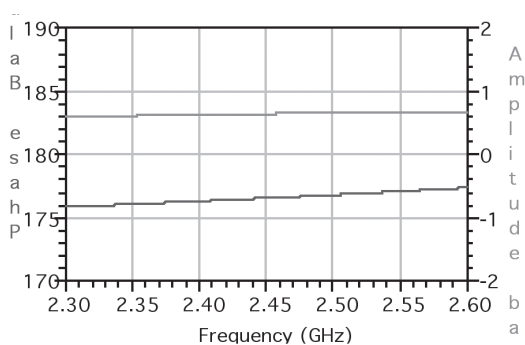

Insertion and Return Loss

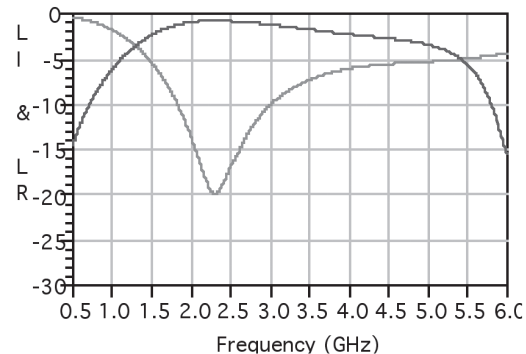

RFBLN1005040YM1T69

Amplitude and Phase Balance

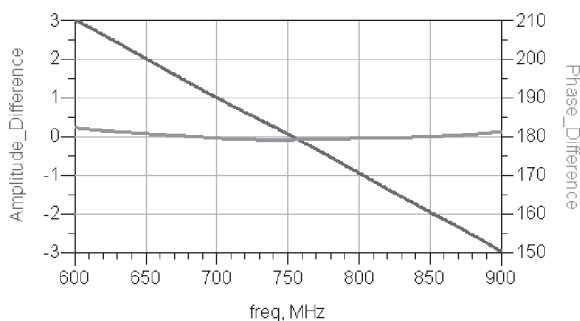

Insertion and Return Loss

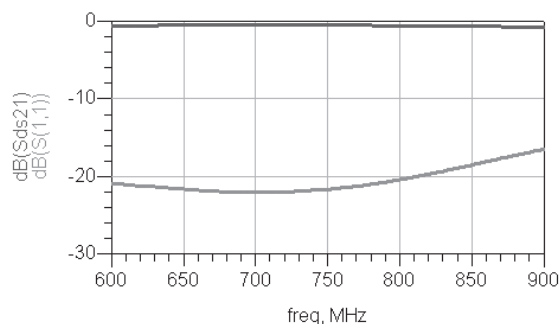

RFBLN16080G9D2T

Amplitude and Phase Balance

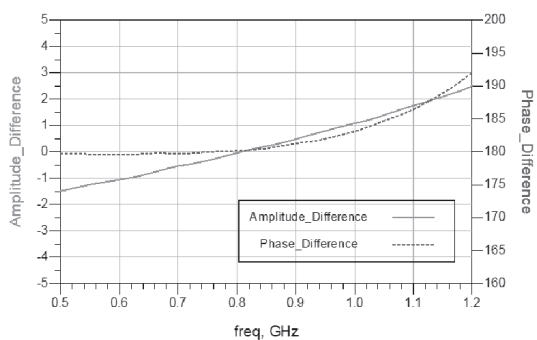

Insertion and Return Loss

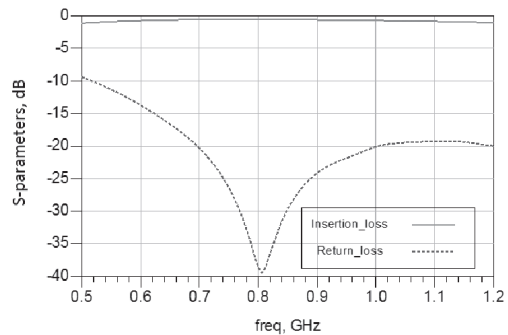

RFBLN10050G9D0T

Amplitude and Phase Balance

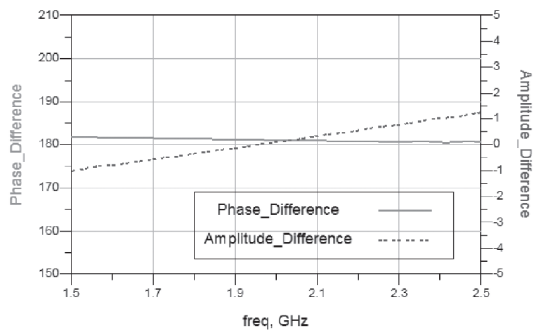

Insertion and Return Loss

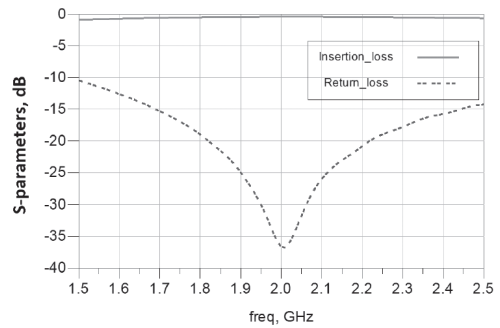

RFBLN10050G9D1T

Amplitude and Phase Balance

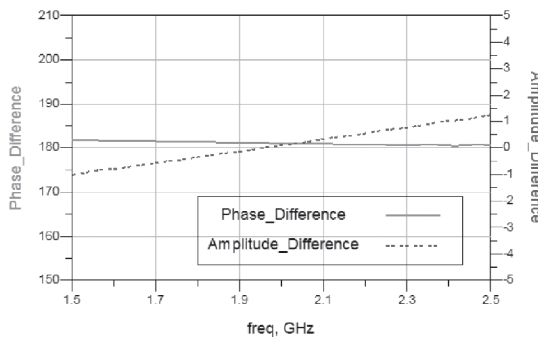

Insertion and Return Loss

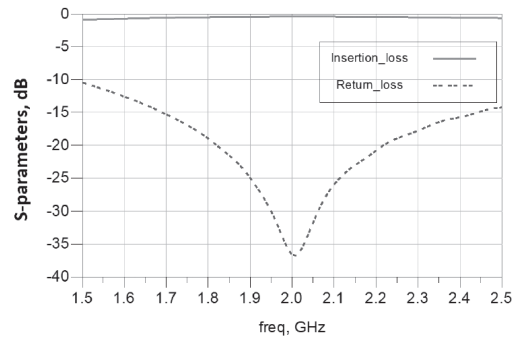

RFBLN06052G5WM9T16

Amplitude and Phase Balance

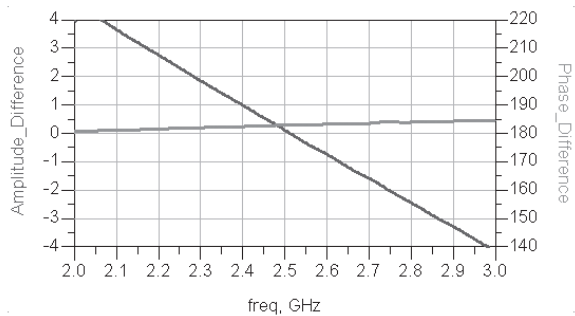

Insertion and Return Loss

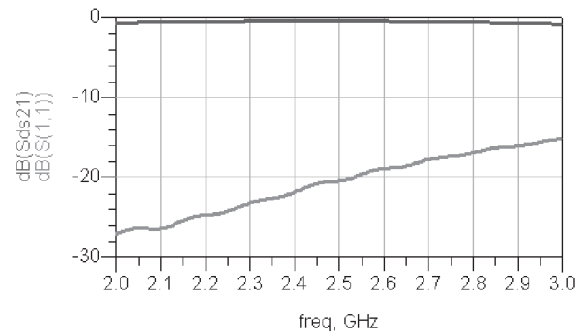

RFBLN10052G5WM9T16

Amplitude and Phase Balance

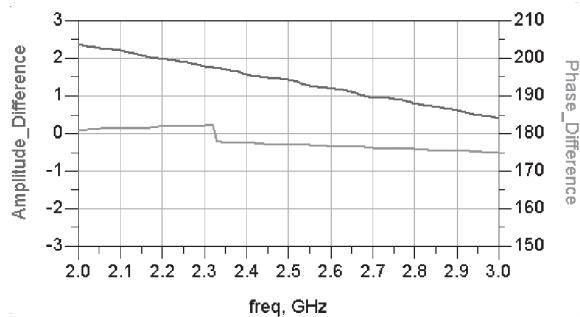

Insertion and Return Loss

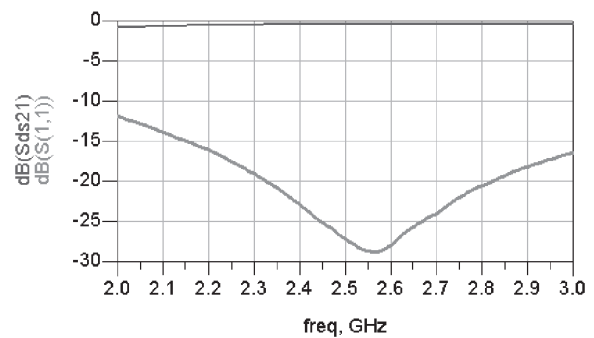

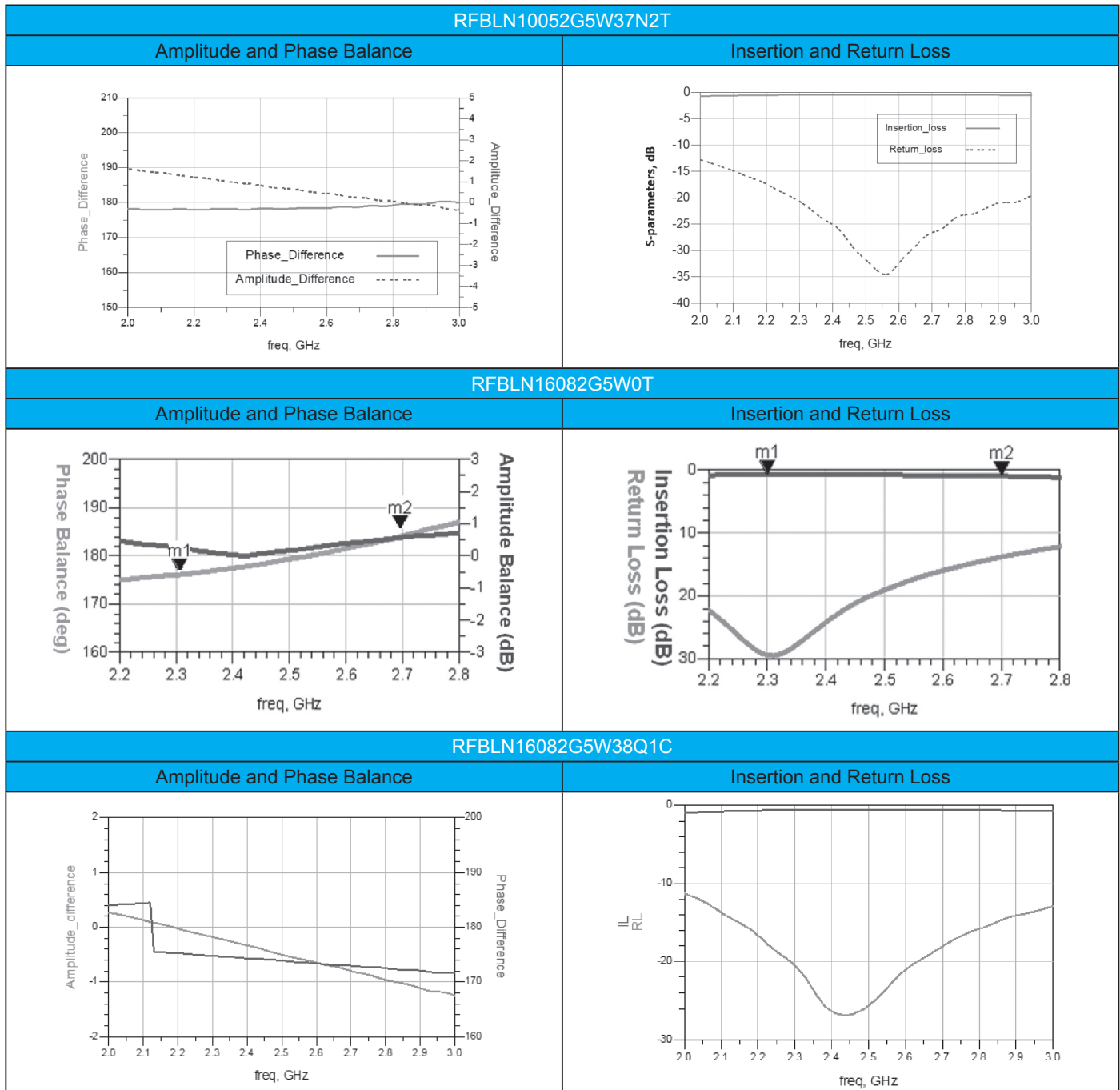

- For more information, please contact with local sales representative
- All specifications are subject to change without notice

■ STRUCTURE AND PIN ASSOCIATED

STRUCTURE A		
STRUCTURE B		
STRUCTURE C		
	<p>STRUCTURE C-1</p>	<p>STRUCTURE C-2</p>
STRUCTURE D		
	<p>STRUCTURE D-1</p>	<p>STRUCTURE D-2</p>
	<p>STRUCTURE D-3</p>	<p>STRUCTURE D-4</p>

■ STRUCTURE AND DIMENSION

Unit:mm

Structure Dimension	L	W	T	A	B	C	D	E	F
A	2.50±0.15	2.00±0.15	0.80±0.10	0.30±0.10	0.40±0.10	0.55±0.10	0.40±0.10	0.90±0.10	0.30±0.10
B	2.00±0.15	1.25±0.15	0.95±0.10	0.20±0.20	0.30±0.20	0.35±0.20	0.65±0.20	0.25±0.20	0.30±0.20
C	1.60±0.15	0.80±0.15	0.60±0.10	0.65±0.15	0.30±0.15	0.20±0.15	0.20±0.15	0.25±0.15	0.30±0.15
D	1.60±0.15	0.80±0.15	0.60±0.10	0.175±0.15	0.25±0.15	0.25±0.15	0.50±0.15	0.20±0.15	-
	2.00±0.10	1.25±0.20	0.55±0.15	0.20±0.15	0.30±0.15	0.35±0.15	0.65±0.15	0.20±0.10	-
	2.00±0.15	1.25±0.15	0.95±0.10	0.20±0.20	0.30±0.20	0.35±0.20	0.65±0.20	-	-

■ ELECTRICAL SPECIFICATION

■ ISM Band 2.4/5GHz Application

Part Number	Frequency (MHz)	Impedance (Ω)	Insertion Loss (dB)	Attenuation (dB)	Return Loss (dB) Min.	Isolation	Size (mm)	Structure
RFDIP1608060LOT	2400~2500	50	0.8	18(4800~5000MHz) 20(7200~7500MHz)	10	-	1.60x0.80x0.60	D-1
	4900~5900	50	1.2	20(3700~3900MHz) 20(1800~2500MHz) 20(9800~11800MHz)				
RFDIP1608060L3T	2400~2500	50	0.8	18(4800~5000MHz) 20(7200~7500MHz)	10	-	1.60x0.80x0.60	D-2
	4900~5900	50	1.2	20(3700~3900MHz) 20(1800~2500MHz) 20(9800~11800MHz)				
RFDIP1608060LBT	2400~2500	50	0.6	20(4800~5000MHz) 20(7200~7500MHz)	10	28(30~2700 MHz) 26(4900~5950 MHz)	1.60x0.80x0.60	D-3
	4900~5900	50	1.4	28(30~2700MHz) 10(9800~11900MHz)				
RFDIP1608060LCT	2400~2500	50	0.6	20(4800~5000MHz) 20(7200~7500MHz)	10	28(30~2700 MHz) 26(4900~5950 MHz)	1.60x0.80x0.60	D-4
	4900~5900	50	1.4	28(30~2700MHz) 10(9800~11900MHz)				
RFDIP1608060LET	2400~2500	50	0.6	18(4800~5000MHz) 18(7200~7500MHz)	10	-	1.60x0.80x0.60	D-1
	4900~5900	50	1.4	20(3700~3900MHz) 20(1800~2500MHz) 10(9800~11800MHz)				
RFDIP1608060LFT	2400~2500	50	0.6	18(4800~5000MHz) 18(7200~7500MHz)	10	-	1.60x0.80x0.60	D-2
	4900~5900	50	1.4	20(3700~3900MHz) 20(1800~2500MHz) 10(9800~11800MHz)				
RFDIP160806ALM6T25	2400~2500	50	0.5	10(3600~3750MHz) 20(4800~5000MHz) 20(5000~5950MHz) 10(7200~7500MHz) 10(9600~10000MHz)	10	-	1.60x0.80x0.60	D-1
	4900~5950	50	0.6	25(860~960MHz) 25(1545~1605MHz) 25(1710~1990MHz) 30(2170 MHz) 10(8100~8800 MHz) 15(8820~9800 MHz) 25(9800~11900 MHz)				
RFDIP160806BLM6T30	2400~2500	50	0.5	10(3600~3750MHz) 20(4800~5000MHz) 20(5000~5950MHz) 10(7200~7500MHz) 10(9600~10000MHz)	10	-	1.60x0.80x0.60	D-2
	4900~5950	50	0.6	25(860~960MHz) 25(1545~1605MHz) 25(1710~1990MHz) 30(2170 MHz) 10(8100~8800 MHz) 15(8820~9800 MHz) 25(9800~11900 MHz)				
RFDIP1608060LVT	2400~2500	50	0.6	-	10	32(30~2700 MHz) 28(4900~5950 MHz)	1.60x0.80x0.60	D-4
	4900~5950	50	0.8	32(30~2700MHz) 15(9800~11900 MHz) 11(14700~17850 MHz)				

■ ISM Band 2.4/5GHz Application

Part Number	Frequency (MHz)	Impedance (Ω)	Insertion Loss (dB)	Attenuation (dB)	Return Loss (dB)Min.	Size (mm)	Structure
RFDIP2012050L5T	2400~2500	50	0.7	18(4800~6000MHz) 18(7200~7500 MHz)	10	2.00x1.25x0.55	D-1
	4900~5900	50	1.0	19(1800~2500MHz) 25(10300~10700MHz)			
RFDIP2012050L7T	2400~2500	50	0.7	18(4800~6000MHz) 18(7200~7500MHz)	10	2.00x1.25x0.55	D-2
	4900~5900	50	1.0	19(1800~2500MHz) 25(10300~10700MHz)			
RFDIP2012050L8T	2300~2500	50	0.65(25°C) 0.8(-40~+85°C)	20(4600~5000MHz) 20(6900~7500MHz)	10	2.00x1.25x0.55	D-3
	4900~5950	50	1.0	19(1800~2500MHz) 25(10300~10700MHz)			
RFDIP2012100L0T	2450 ± 50	50	0.7	20(4900MHz) 25(5200MHz) 25(5800MHz)	10	2.00x1.25x0.95	D-3
	5400 ± 500	50	0.9	25(2450MHz)			
RFDIP2012100L1T	2450 ± 50	50	0.7	20(4900MHz) 20(5200MHz) 20(5800MHz)	10	2.00x1.25x0.95	C-1
	5400 ± 500	50	0.9	20(2450MHz)			
RFDIP2012100L3T	2450 ± 50	50	0.7	20(4900MHz) 25(5200MHz) 25(5800MHz)	10	2.00x1.25x0.95	D-2
	5400 ± 500	50	0.9	25(2450MHz)			
RFDIP2012100L4T	2450 ± 50	50	0.7	20(4900MHz) 20(5200MHz) 20(5800MHz)	10	2.00x1.25x0.95	C-2
	5400 ± 500	50	1.1	20(2450MHz)			
RFDIP2012050LPT	2450 ± 50	50	0.5(25°C) 0.55(-40~+85°C)	23(4800~6000MHz) 20(7200~7500MHz)	10	2.00x1.25x0.55	D-1
	5425 ± 525	50	0.65(25°C) 0.75(-40~+85°C)	20(800~2500MHz) 15(9800~11900MHz)			
RFDIP2012050LQT	2450 ± 50	50	0.5(25°C) 0.55(-40~+85°C)	23(4800~6000MHz) 20(7200~7500MHz)	10	2.00x1.25x0.55	D-2
	5425 ± 525	50	0.65(25°C) 0.75(-40~+85°C)	20(800~2500MHz) 15(9800~11900MHz)			

■ GPS 1.575GHz/ISM 2.4GHz/5GHz Band Application

Part Number	Frequency (MHz)	Impedance (Ω)	Insertion Loss (dB)	Attenuation (dB)	ReturnLoss (dB)Min.	Size (mm)	Structure
RFDIP1608060T1T	1574~1577	50	0.65	20(2400~2500MHz)	10	1.60x0.80x0.60	B
	2400~2500	50	0.8	20(1574~1577MHz)			
RFDIP1608060TM7T62	1570~1610	50	0.6(typ.0.5)	20(2400~2500MHz) 20(4900~5900MHz)	10	1.60x0.80x0.60	D-4
	2400~2500 4900~5900	50	0.65(typ.0.55)	20(1570~1610MHz)			
RFDIP1608060TM8T62	1570~1610	50	0.65(typ.0.55)	20(2400~2500MHz) 20(4900~5900MHz)	10	1.60x0.80x0.60	D-3
	2400~2500 4900~5900	50	0.65(typ.0.55)	20(1570~1610MHz)			
RFDIP1608060T8T	1570~1610	50	0.45(25°C) 0.55(-40~+85°C)	20(2400~2500MHz)	10	1.60x0.80x0.60	D-4
	2400~2500	50	0.5(25°C) 0.6(-40~+85°C)	20(1560~1607MHz)			
RFDIP1608060T9T	1570~1610	50	0.45(25°C) 0.55(-40~+85°C)	20(2400~2500MHz)	10	1.60x0.80x0.60	D-3
	2400~2500	50	0.5(25°C) 0.6(-40~+85°C)	20(1560~1607MHz)			
RFDIP1608060TAT	698~960 1427~1511 1560~1607	50	0.40 max. 0.55 max. 0.65 max.	20(2400~2500MHz) 20(2620~2690MHz) 20(5150~5850MHz)	10	1.60x0.80x0.60	B
	2400~2500 2620~2690 5150~5850	50	0.70 max. 0.60 max. 0.80 max.	20(698~960MHz) 20(1427~1511MHz) 20(1560~1607MHz)			
RFDIP2520080TM0T62	1570~1580	50	0.7	10(2400~2500MHz)	10	2.50x2.00x0.80	A
	2400~2500	50	3.5	42(824 ~ 894MHz) 42(880 ~ 960MHz) 33(1570 ~ 1580MHz) 30(1710 ~ 1785MHz) 33(1850 ~ 1910MHz) 30(2100 ~ 2170MHz) 40(4800 ~ 5000MHz) 20(7200 ~ 7500MHz)			

■ 892 MHz & 1.94GHz Band Working Frequency

Part Number	Frequency (MHz)	Impedance (Ω)	Insertion Loss (dB)	Attenuation (dB)	ReturnLoss (dB)Min.	Size (mm)	Structure
RFDIP2012090G0T	824~960	50	0.6(25°C) 0.65(-40~+85°C)	15(1710~2170MHz)	10	2.00x1.25x0.90	D-3
	1710~2170		0.6(25°C) 0.65(-40~+85°C)	20(824~960MHz)			
RFDIP2012090G3T	824~960	50	0.6(25°C) 0.65(-40~+85°C)	15(1710~2170MHz)	10	2.00x1.25x0.90	D-4
	1710~2170		0.6(25°C) 0.65(-40~+85°C)	20(824~960MHz)			

■ TYPICAL ELECTRICAL CHARACTERISTICS

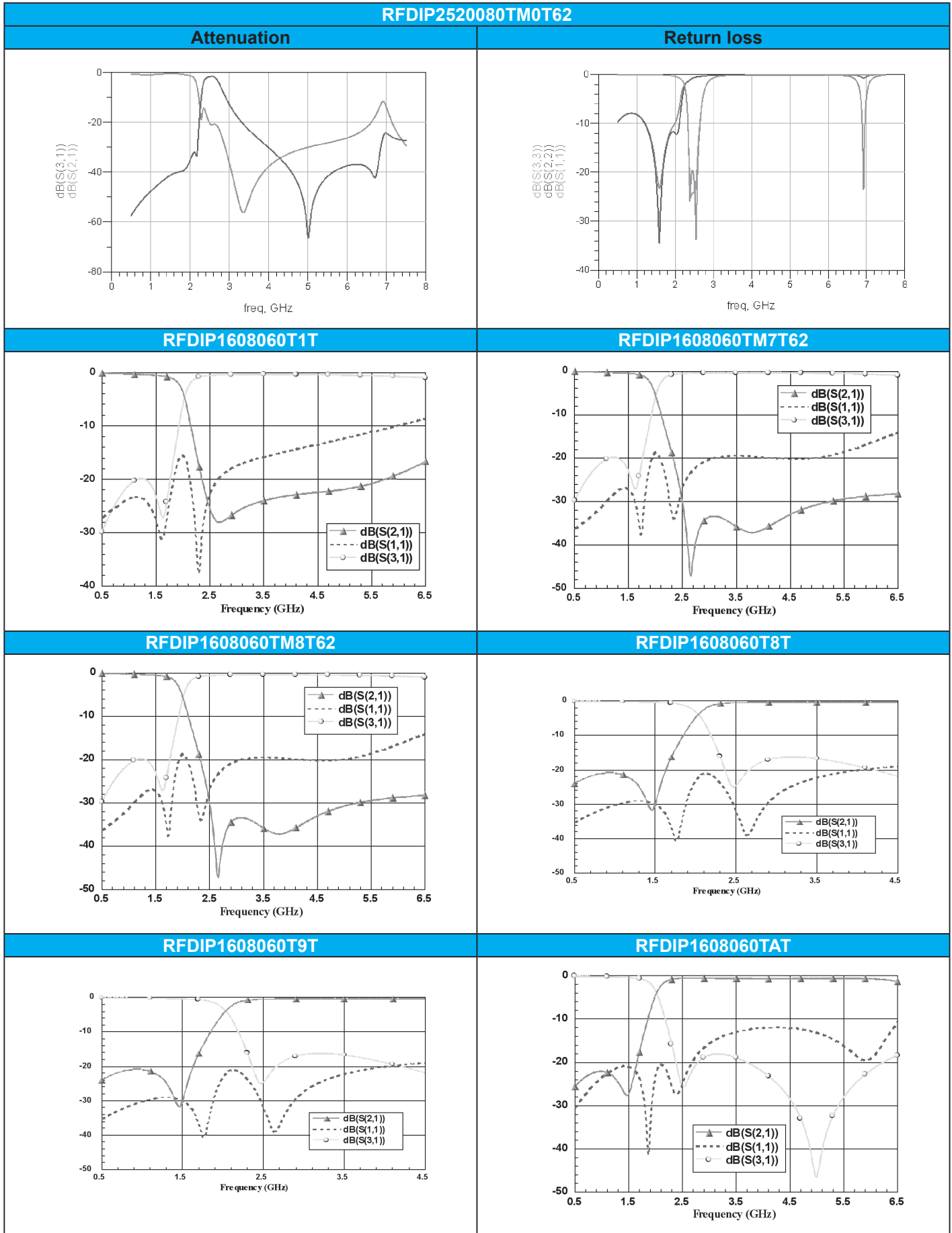

RFDIP1608060LET

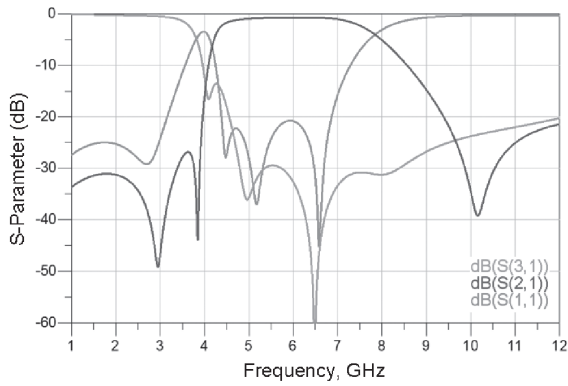

RFDIP1608060LBT

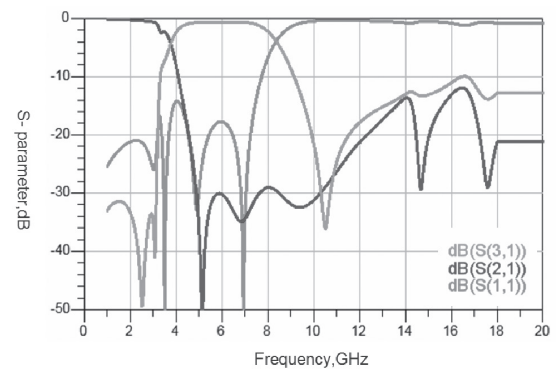

RFDIP1608060LOT

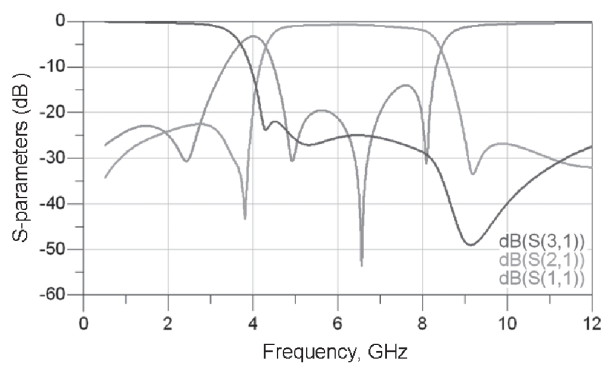

RFDIP1608060L3T

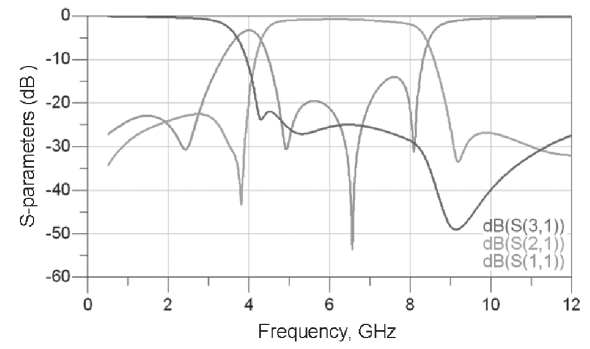

RFDIP160806ALM6T25

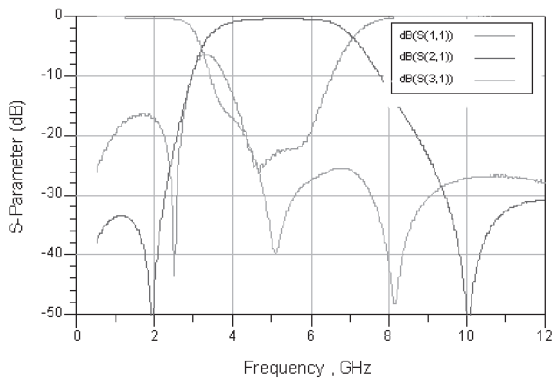

RFDIP1608060LVT

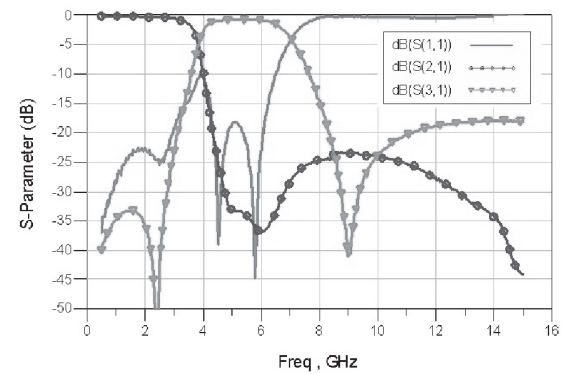

RFDIP2012050LPT

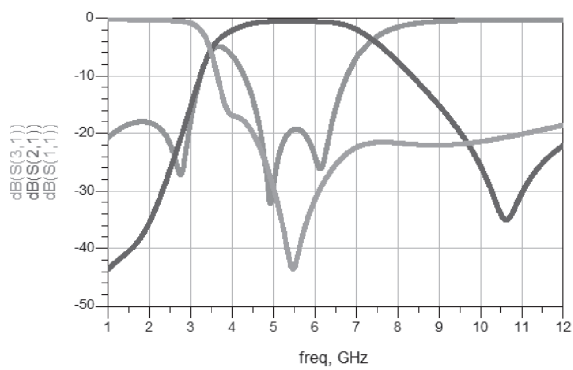

RFDIP2012050LQT

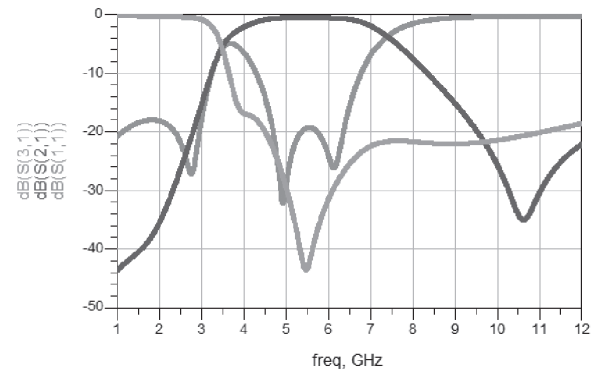

■ TYPICAL ELECTRICAL CHARACTERISTICS

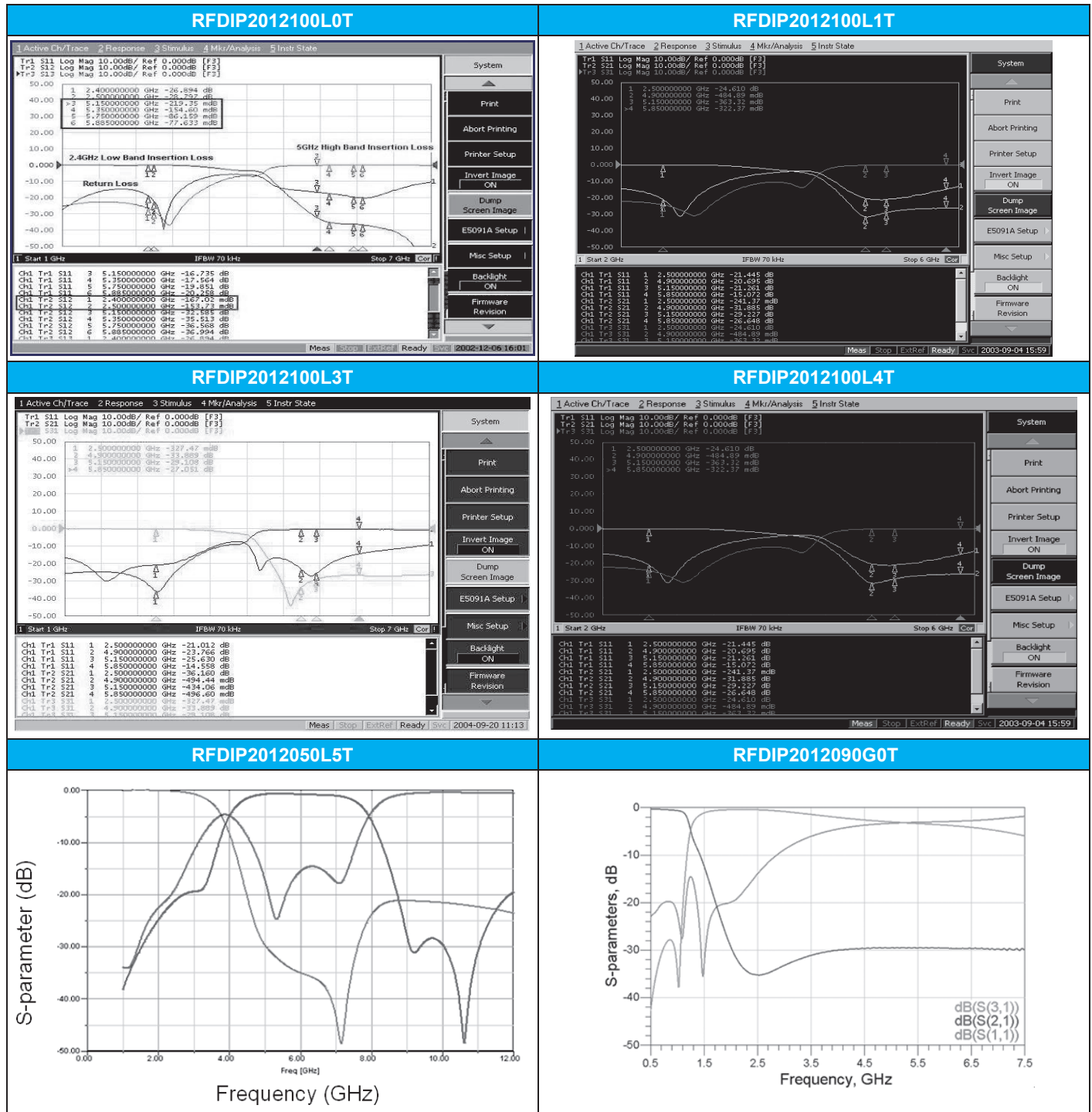

■ For more information, please contact with local sales representative

■ All specifications are subject to change without notice

■ STRUCTURE AND PIN ASSOCIATED

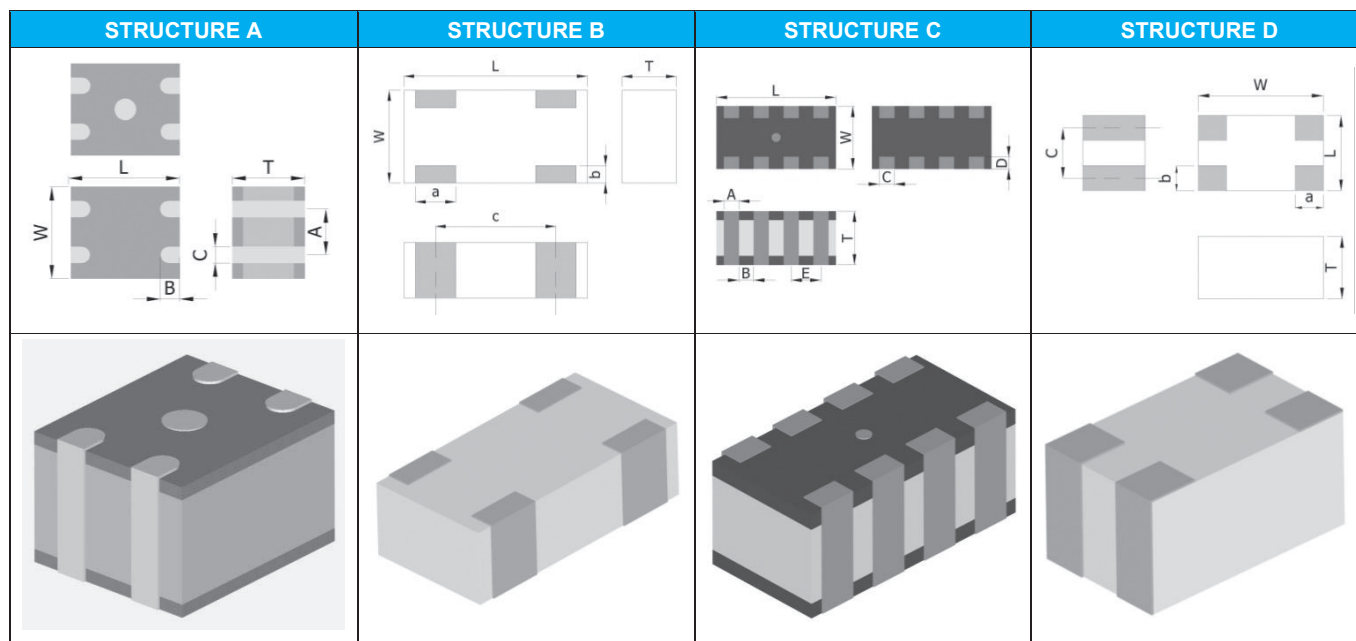

■ STRUCTURE AND DIMENSION

Unit:mm

Structure Dimension	L	W	T	a	b	c	d	e
A	1.25±0.10	1.00±0.10	0.80±0.10	0.55±0.10	0.20±0.15	0.30±0.15	-	-
	2.00±0.10	1.25±0.10	1.00±0.10	0.68±0.15	0.35±0.15	0.35±0.15	-	-
B	3.20±0.20	1.60±0.20	0.95±0.20	0.70±0.20	0.30±0.20	2.10±0.20	-	-
C	2.00±0.15	1.050±0.15	0.90±0.10	0.25±0.15	0.25±0.10	0.35±0.10	0.20±0.15	0.50±0.15
D	1.20+0.40 -0.20	1.20+0.40 -0.20	1.00±0.20	0.45±0.20	0.40±0.20	0.80±0.10	-	-
	1.60±0.20	3.20±0.20	1.00±0.20 1.40±0.20	0.60±0.20 0.60±0.20	0.50±0.20 0.50±0.20	1.10±0.20 1.10±0.20	- -	- -

■ ELECTRICAL SPECIFICATION

■ DISCRETE CMF for HIGH SPEED TRANSMISSION LINES、USB2.0、IEEE1394、LVDS(mini)

Part Number	Characteristic Impedance (Differential)	Impedance (Ω) Common Mode	DC Resistance (Ω) max.	Rated Current (mA)	Size(mm)	Structure
RGCMF1210350X0T	90 ohm	35± 25%(100MHz)	0.7	300	1.25x1.00x0.80	A
RGCMF1210650X1T	90 ohm	65± 20%(100MHz)	0.85	300	1.25x1.00x0.80	A
RGCMF1210101X2T	90 ohm	100± 20%(100MHz)	1.5	300	1.25x1.00x0.80	A
RGCMF1210900X3T	90 ohm	90± 20%(100MHz)	1.5	300	1.25x1.00x0.80	A
RGCMF1210121X4T	90 ohm	120± 20%(100MHz)	1.5	300	1.25x1.00x0.90	A
RGCMF1220121X5T	90 ohm	120± 20%(100MHz)	1.5	400	1.25x2.00x1.00	A

■ DISCRETE CMF for HIGH SPEED TRANSMISSION LINES、USB2.0、IEEE1394、LVDS(mini)

Part Number	Characteristic Impedance (Differential)	Common Mode Attenuation (Min.)	DC Resistance (Ω) max.	Rated Current (mA)	Size(mm)	Structure
RFCMF1220100M3T	90 ohm	9.0(240MHz ~ 1GHz)	1.5	300	1.20x2.00x1.00	D
RFCMF1220100M4T	90 ohm	9.0(130 MHz ~ 1GHz)	2.5	200	1.20x2.00x1.00	D
RFCMF1632100M3T	90 ohm	9.0(240 MHz ~ 1.0 GHz)	1.5	300	1.60x3.20x1.00	D
RFCMF1632140M2T	90 ohm	9.0(140 MHz ~ 1.0 GHz)	2.5	300	1.60x3.20x1.40	D
RGCMF3216090M1T	90 ohm	8(240MHz ~ 1.0GHz)	1.5	200	3.20x1.60x0.95	B

■ DISCRETE CMF for HIGH SPEED TRANSMISSION LINES/ HDMI/MIPI/ mini LVDS/ DVI/ SATA/ PCI-E DVI Display Port

Part Number	Characteristic Impedance (Differential)	Impedance(Ω)	DC Resistance (Ω) max.	Rated Current (mA)	Size (mm)	Structure
RGCMF1210350H0T	100 ohm	35 \pm 25%(100MHz)	0.6	300	1.25x1.00x0.80	A
RGCMF1210650H1T	100 ohm	65 \pm 20%(100MHz)	0.8	300	1.25x1.00x0.80	A
RGCMF1210101H2T	100 ohm	100 \pm 20%(100MHz)	1.0	300	1.25x1.00x0.80	A
RGCMF1210900H3T	100 ohm	90 \pm 20%(100MHz)	1.0	300	1.25x1.00x0.80	A
RGCMF1210121H4T	100 ohm	120 \pm 20%(100MHz)	1.2	300	1.25x1.00x0.80	A
RGCMF1210900H7T	100 ohm	90 \pm 20%(100MHz)	1.0	300	1.25x1.00x0.80	A
RGCMF2012900H1T	100 ohm	90 \pm 20%(100MHz)	1.0	200	2.00x1.25x1.00	A

■ USB3.0

Part Number	Cut-off Frequency	Impedance(Ω)	DC Resistance (Ω) max.	Rated Current (mA)	Size (mm)	Structure
RGCMF1210180U0T	8 GHz (Typical)	18 \pm 25%(100MHz)	0.5	300	1.25x1.00x0.80	A
RGCMF1210350U0T	7 GHz (Typical)	35 \pm 20%(100MHz)	0.8	300	1.25x1.00x0.80	A

■ ARRAY CMF for HIGH SPEED TRANSMISSION LINES/ HDMI/MIPI/ mini LVDS/ DVI/ SATA/ PCI-E DVI Display Port

Part Number	Characteristic Impedance (Differential)	Impedance(Ω)	DC Resistance (Ω) max.	Rated Current (mA)	Size (mm)	Structure
RGCA2010090V2T	100 ohm	100 \pm 25%(100MHz)	1.1	300	2.00x1.05x0.90	C
RGCA2010090V3T	100 ohm	90 \pm 25%(100MHz)	1.0	300	2.00x1.05x0.90	C
RGCA2010090V4T	100 ohm	120 \pm 25%(100MHz)	1.1	300	2.00x1.05x0.90	C

■ For more information, please contact with local sales representative

■ All specifications are subject to change without notice

TYPICAL ELECTRICAL CHARACTERISTICS

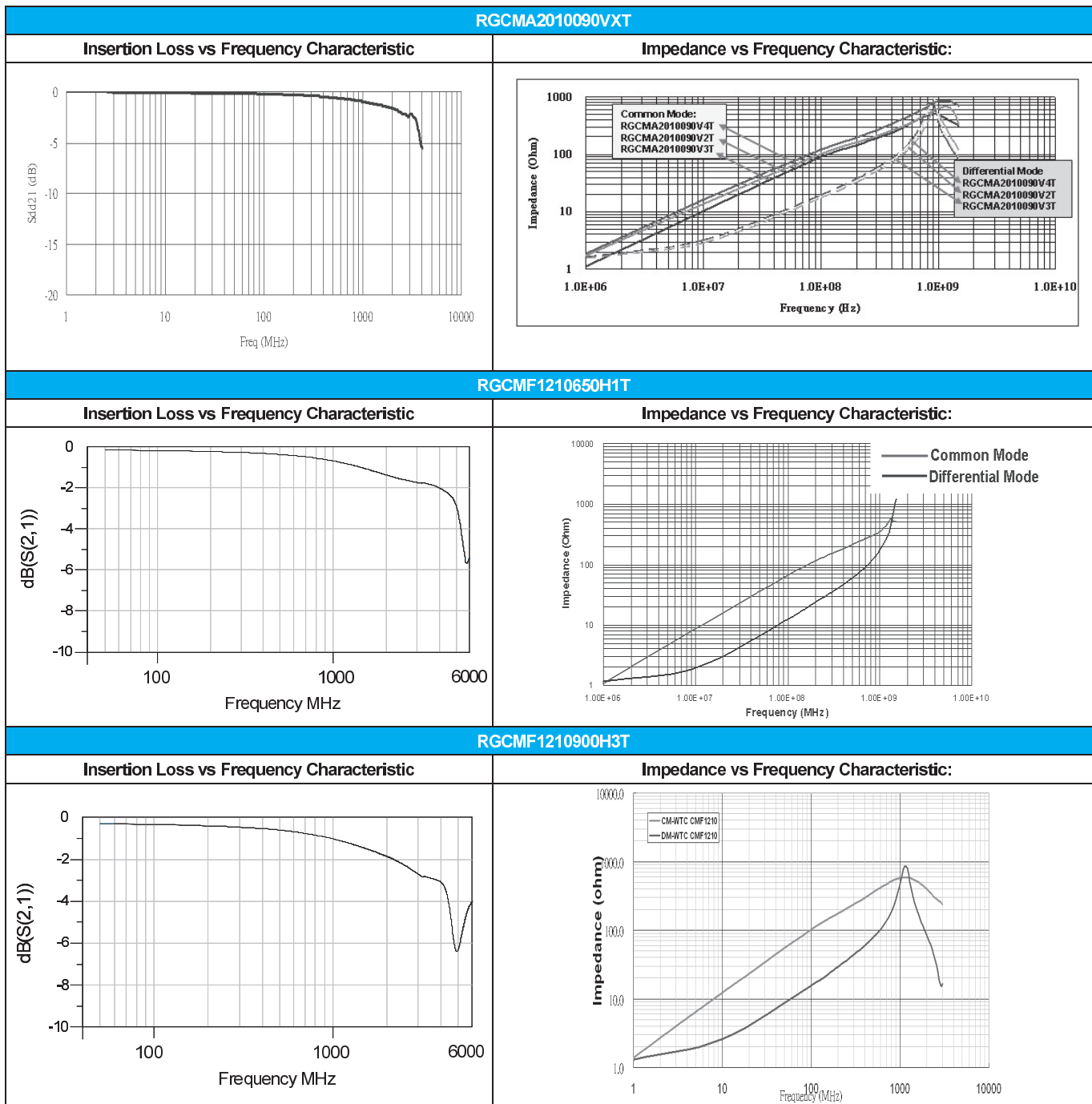

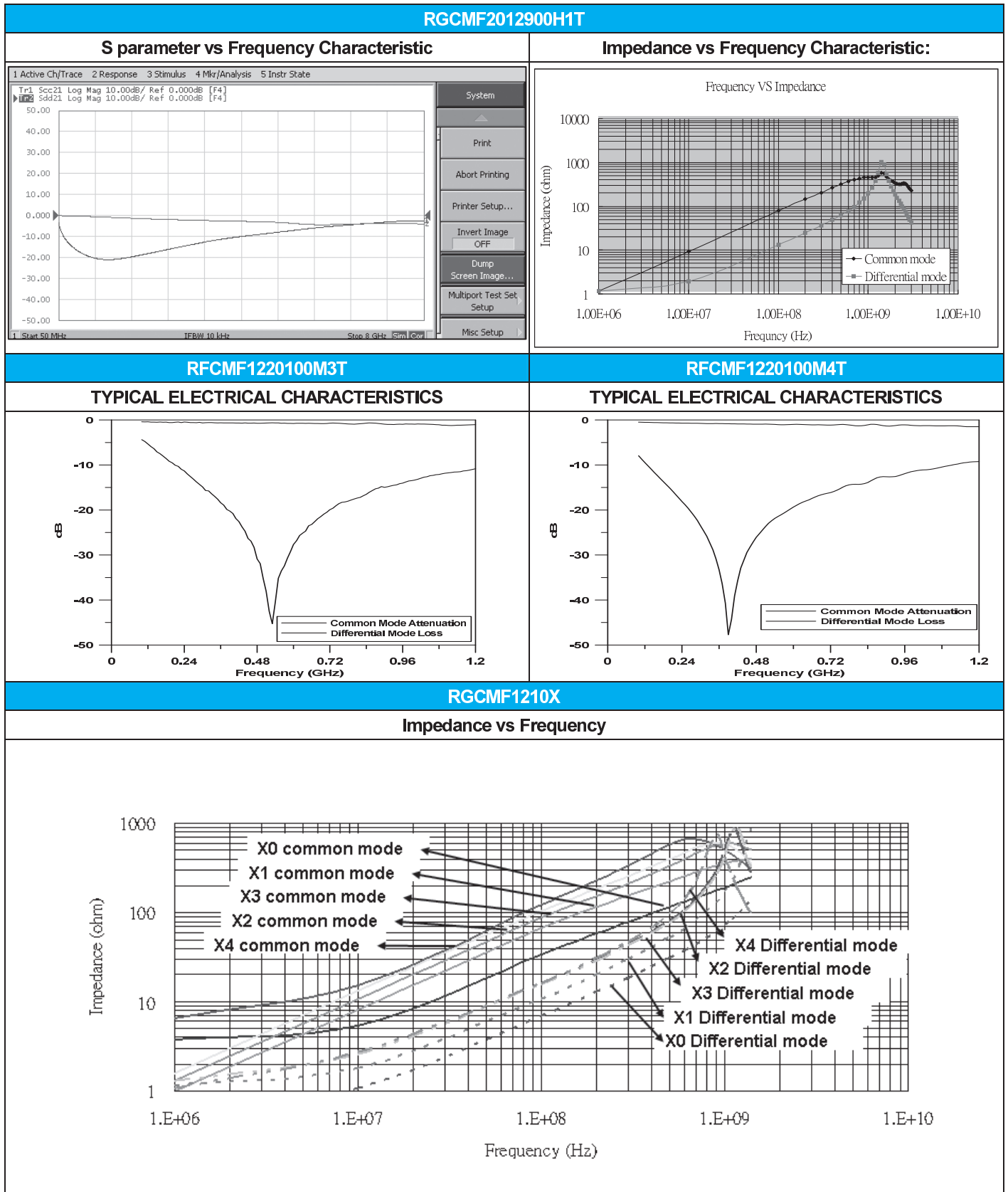

■ For more information, please contact with local sales representative

■ All specifications are subject to change without notice

■ STRUCTURE AND PIN ASSOCIATED

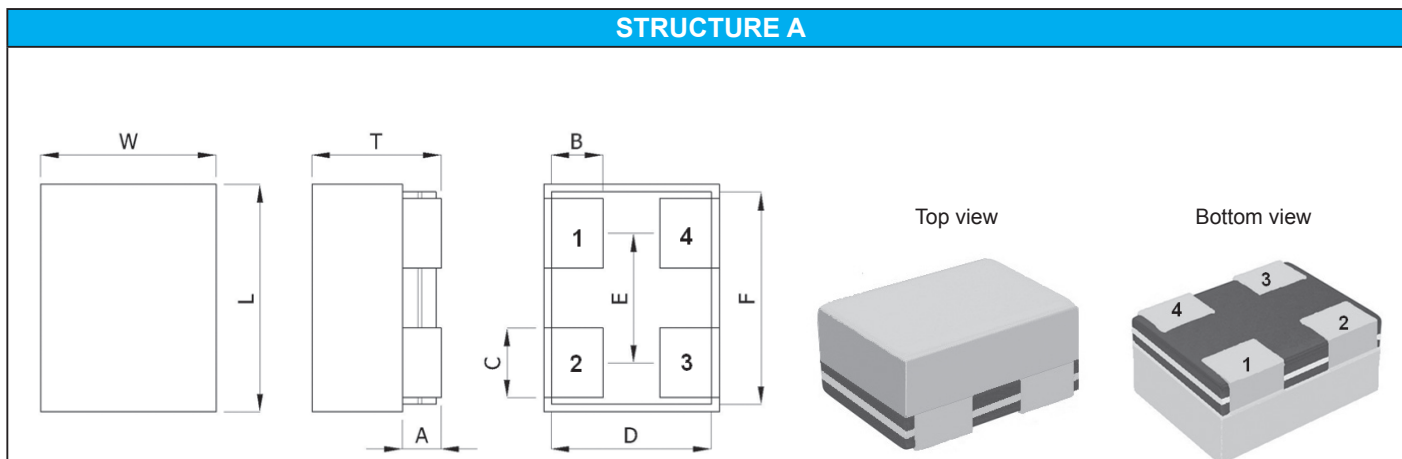

■ STRUCTURE AND DIMENSION

Structure Dimension	L	W	T	A	B	C	D	E	Unit:mm
A	0.88±0.05	0.68±0.05	0.50±0.05	0.15±0.05	0.20±0.05	0.27±0.10	0.62±0.05	0.50±0.05	0.82±0.05

■ ELECTRICAL SPECIFICATION

Type	Common Mode Impedance (Ω)	Max. DC Resistance (Ω)	Rated Current (mA)	Rated Voltage Ed(V)	Cut off Frequency (GHz) typ.	Insulation Resistance (MΩ) min.
RGTCM0806900H0T	90±25%	2.8±30%	100	10	4G	10
RGTCM0806650H0T	65±20%	2.5±30%	100	10	5G	10
RGTCM0806350H0T	35±20%	1.8±30%	100	10	8G	10

■ TYPICAL ELECTRICAL CHARACTERISTICS

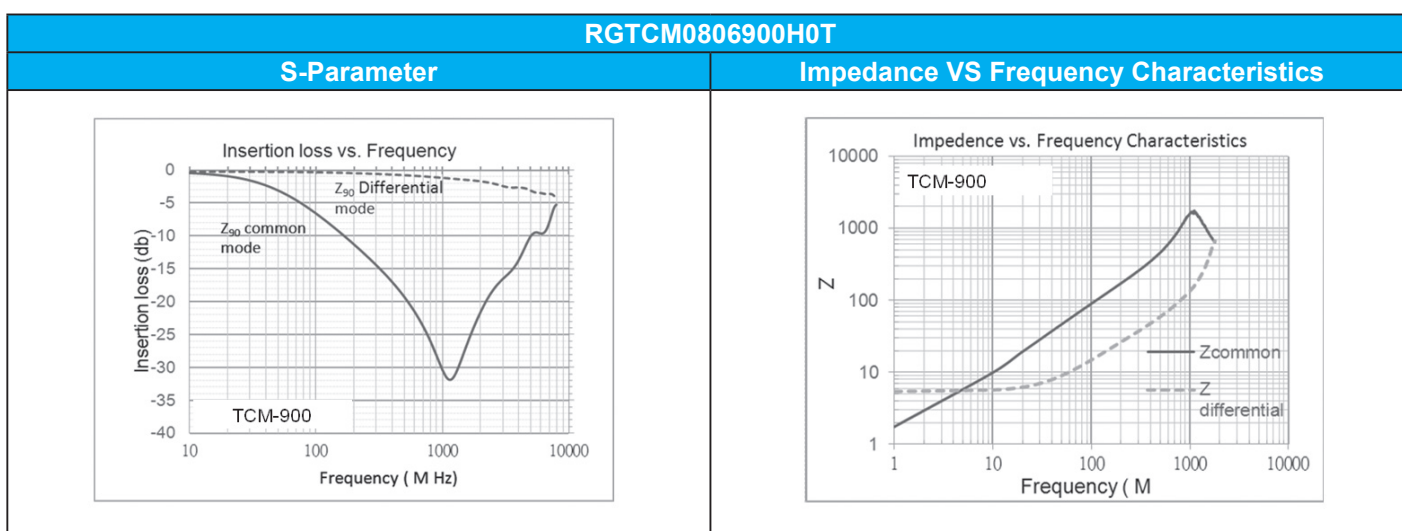

RGTCM0806650H0T

S-Parameter

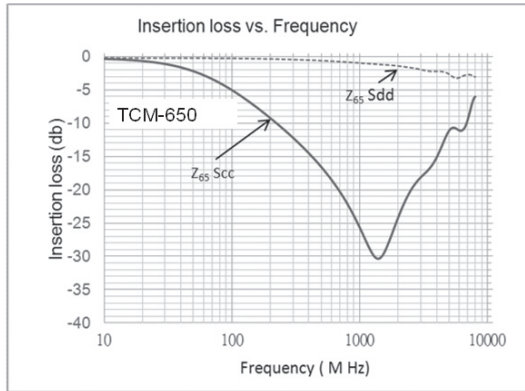

Impedance VS Frequency Characteristics

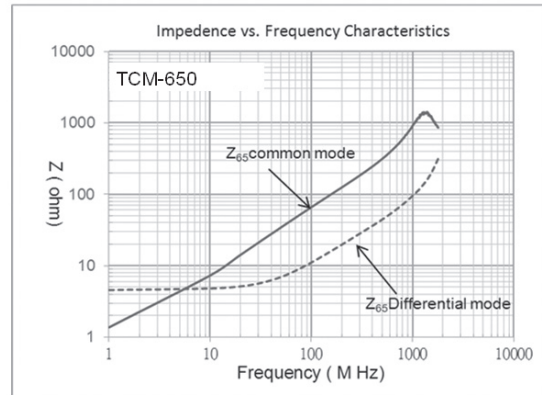

RGTCM0806350H0T

S-Parameter

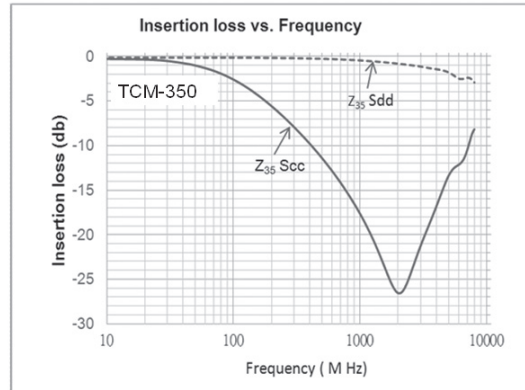

Impedance VS Frequency Characteristics

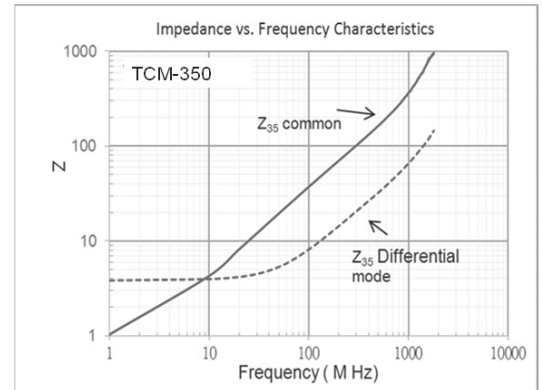

- For more information, please contact with local sales representative
- All specifications are subject to change without notice

■ STRUCTURE AND PIN ASSOCIATED

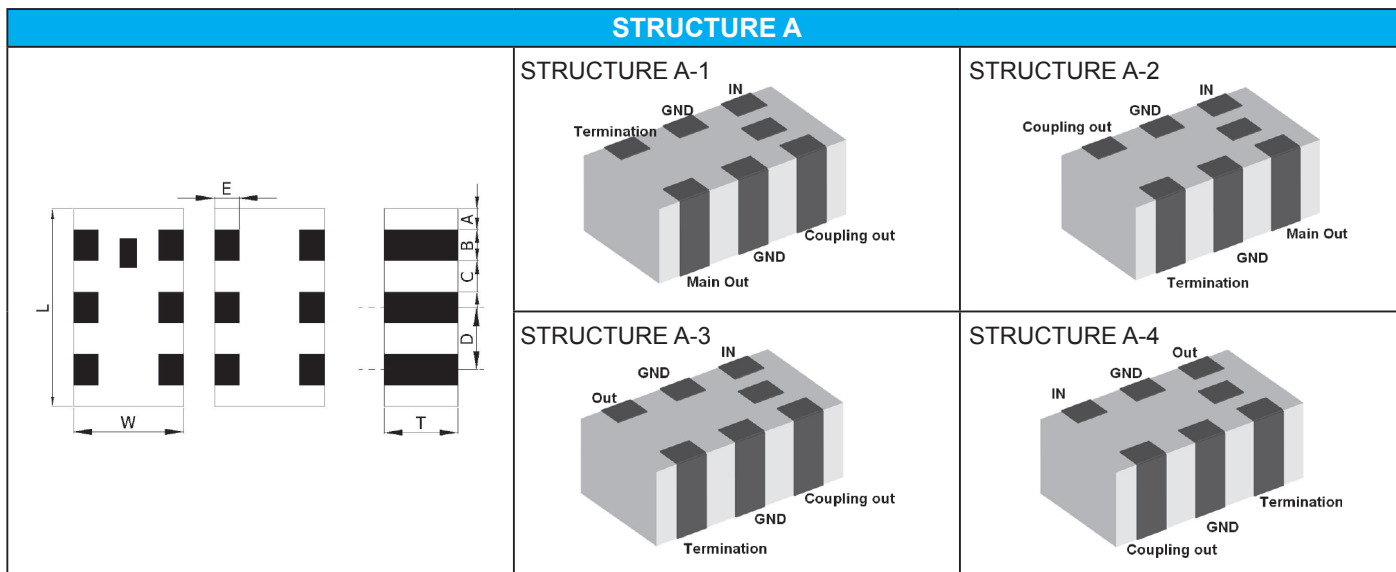

■ STRUCTURE AND DIMENSION

Unit:mm

Structure Dimension	L	W	T	A	B	C	D	E
A	1.60±0.10	0.80±0.10	0.60±0.10	0.10±0.10	0.30±0.10	0.25±0.10	0.55±0.10	0.20±0.10
	1.60±0.10	0.80±0.10	0.60±0.10	0.175±0.10	0.25±0.10	0.25±0.10	0.50±0.10	0.20±0.10

■ ELECTRICAL SPECIFICATION

■ ISM Band 2.4GHz APPLICATION

Part Number	Frequency (MHz)	Insertion Loss (dB)	Coupling in BW	Isolation in BW	VSWR	Dimension (mm ³)	Structure
RFCPL1806B2450T	2450 ± 50	1.83	6.5 ± 1.0 dB	21.0 dB min	1.5	1.60x1.80x0.60	A-2
RFCPL1807B2450T	2450 ± 50	1.30	7.0 ± 1.0 dB	30.0 dB min	2.0	1.60x1.80x0.60	A-1
RFCPL1810B2450T	2450 ± 50	0.74	10.0 ±1.0 dB	22.0 dB min	1.8	1.60x1.80x0.60	A-2

■ LTE BAND APPLICATION

Part Number	Frequency (MHz)	Insertion Loss (dB)	Coupling in BW	Directivity in BW dB (min.)	Isolation in BW dB (min.)	VSWR	Dimension (mm ³)	Structure
RFCPL1608070P08Q1C	698~2690	0.20(698~960MHz) 0.22(1427.9~2170MHz) 0.25(2300~2690MHz)	23.0~27.0(698~915MHz) 21.5~26.5(1427.9~2025MHz) 22.5~27.5(2300~2620MHz)	20.	-	1.5	1.60x1.80x0.60	A-3
RFCPL1608070P18Q1C	698~2690	0.20(698~960MHz) (Typ.0.02) 0.22(1710~2170MHz) (Typ.0.07) 0.25(2300~2690MHz) (Typ.0.10)	23.0~27.0(698~915MHz) 21.5~26.5(1710~2025MHz) 22.5~27.5(2300~2620MHz)	20	-	1.45	1.60x1.80x0.60	A-4
RFCPL1608070P28Q1C	698~2690	0.20(698~960MHz) 0.22(1427.9~2170MHz) 0.25(2300~2690MHz)	23.0~27.0(698~915MHz) 21.5~26.5(1427.9~2025MHz) 22.5~27.5(2300~2620MHz)	20	-	1.5	1.60x1.80x0.60	A-3
RFCPL1608070P38Q1C	698~2690	0.20(698~960MHz) 0.22(1710~2170MHz) 0.25(2300~2690MHz)	23.0~27.0(698~915MHz) 21.5~26.5(1710~2025MHz) 22.5~27.5(2300~2620MHz)	20	-	1.45	1.60x1.80x0.60	A-4
RFCPL1608070PM9T16	700~2700	0.2(700~790MHz) (Typ.0.07) 0.2(820~900MHz) (Typ.0.07) 0.3(1701~2100MHz) (Typ.0.15) 0.3(2300~2700MHz) (Typ.0.15)	24~27(700~790MHz) 24~27(820~900MHz) 20~23(1701~2100MHz) 20~23(2300~2700MHz)	-	40(700~790MHz) 40(820~900MHz) 35(1701~2100MHz) 35(2300~2700MHz)	1.45	1.60x1.80x0.60	A-2

■ TYPICAL ELECTRICAL CHARACTERISTICS

RFCPL1806B2450T

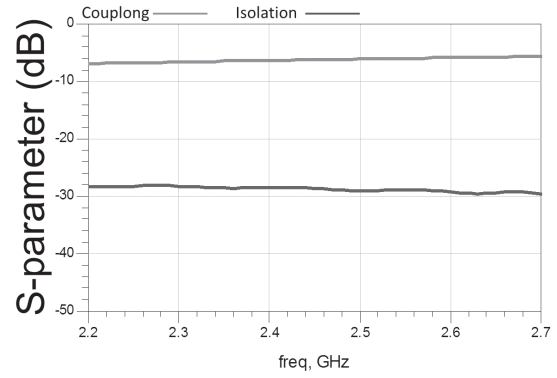
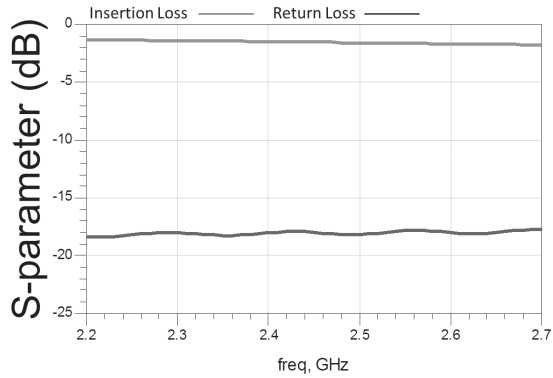

RFCPL1807B2450T

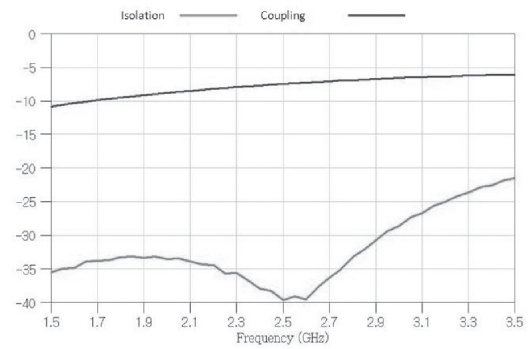
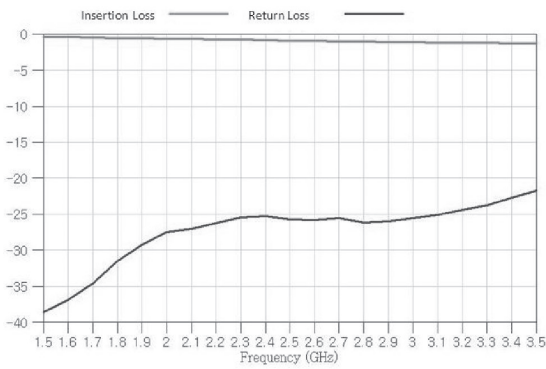

RFCPL1810B2450T

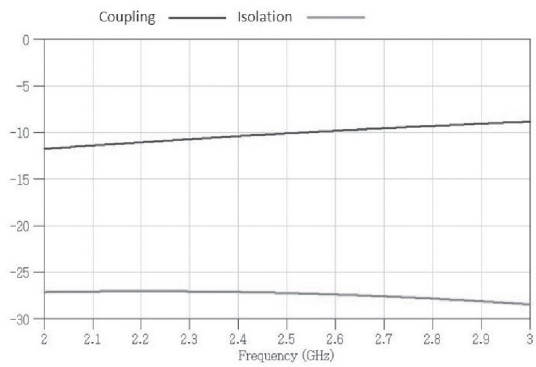
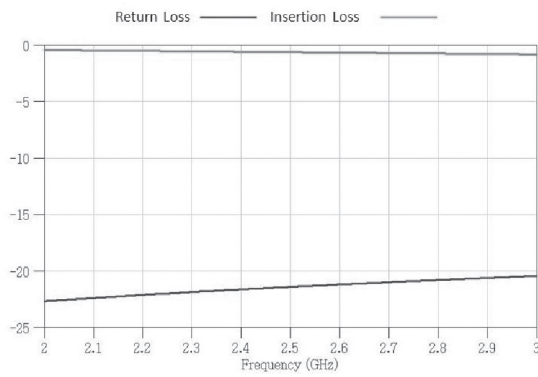

RFCPL1608070P08Q1C

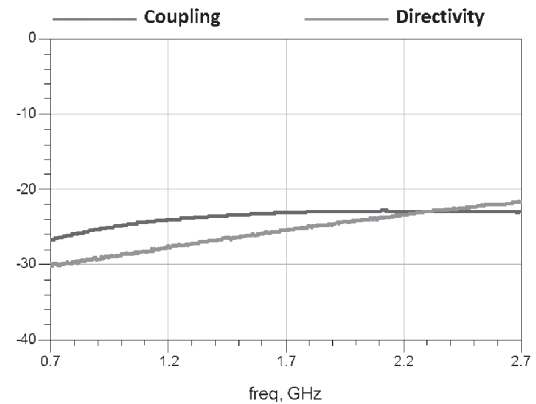
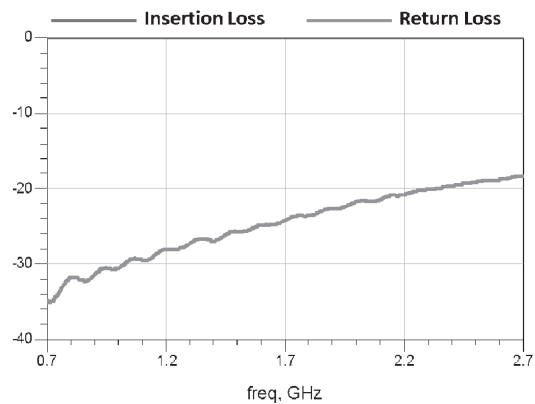

RFCPL1608070P18Q1C

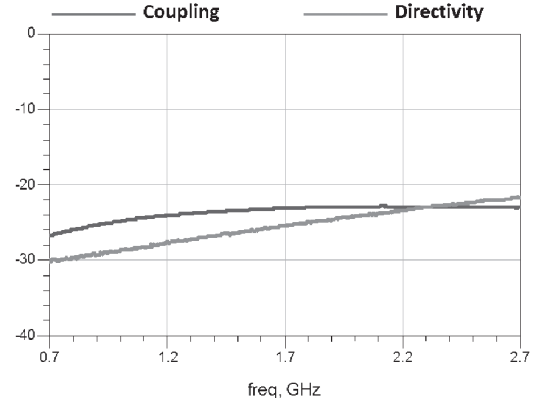
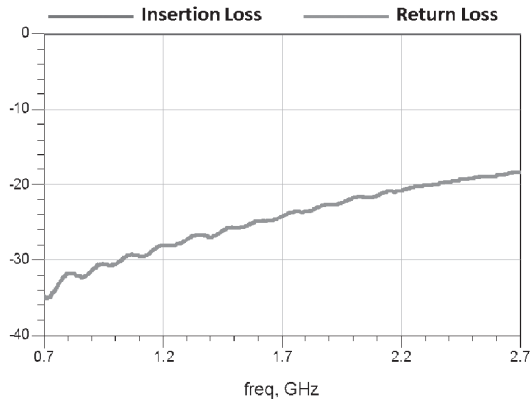

RFCPL1608070P28Q1C

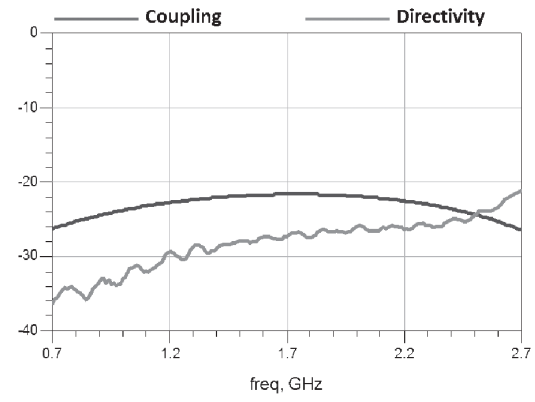
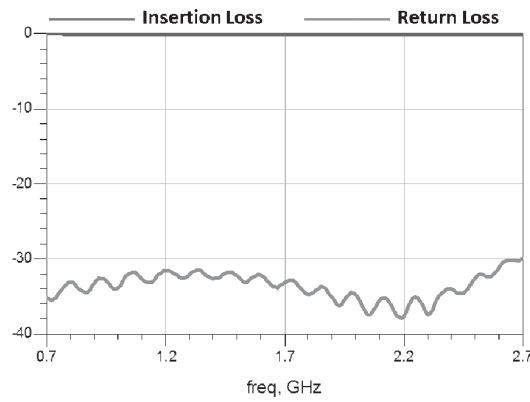

RFCPL1608070P38Q1C

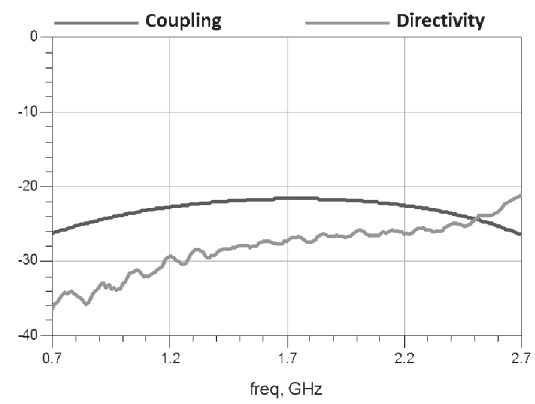
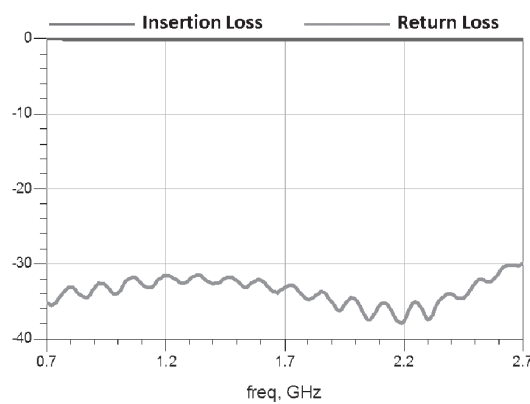

RFCPL1608070PM9T16

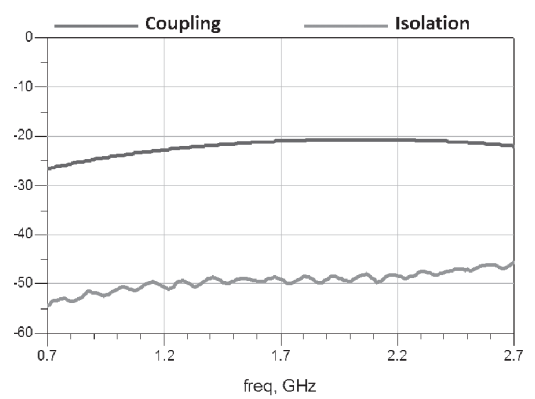
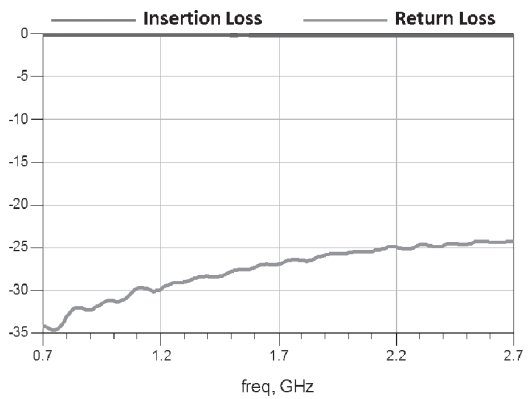

■ For more information, please contact with local sales representative

■ All specifications are subject to change without notice

■ STRUCTURE AND PIN ASSOCIATED

STRUCTURE A

Pin Assignment	
Channel	I/O
Channel 1	PIN 1/9
Channel 2	PIN 2/8
Channel 3	PIN 3/7
Channel 4	PIN 4/6
1, 2, 3, 4	IN
9, 8, 7, 6	OUT
5, 10	Ground

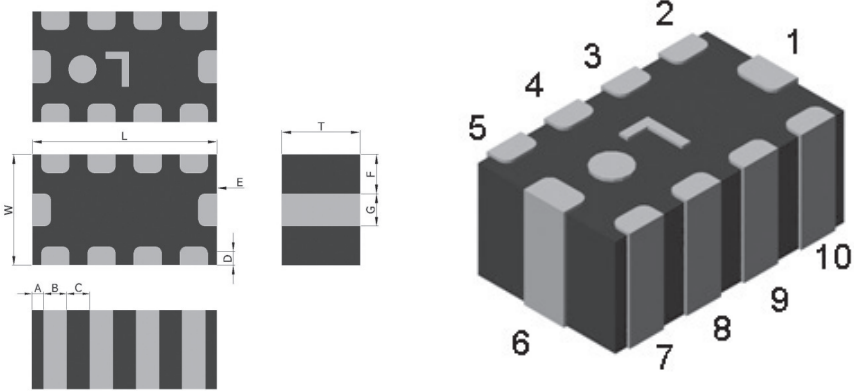

■ STRUCTURE AND DIMENSION

Unit:mm

Structure Dimension	L	W	T	A	B	C	D	E	F	G
A	2.05 ± 0.20	1.25 ± 0.20	0.70 ± 0.10	0.15 ± 0.10	0.25 ± 0.10	0.25 ± 0.10	0.20 ± 0.15	0.20 ± 0.15	0.45 ± 0.10	0.35 ± 0.10

■ ELECTRICAL SPECIFICATION

Part Number	-3dB Cut-off Frequency (20MHz)	Attenuation (min.)	Size(mm)	Structure
RFEMA2012070R18T1U	0-6dB @ 20 MHz	15(100 MHz) 32(800 MHz) 35(1500 MHz) 23(2400 MHz)	2.05x1.25x0.70	A

■ TYPICAL ELECTRICAL CHARACTERISTICS

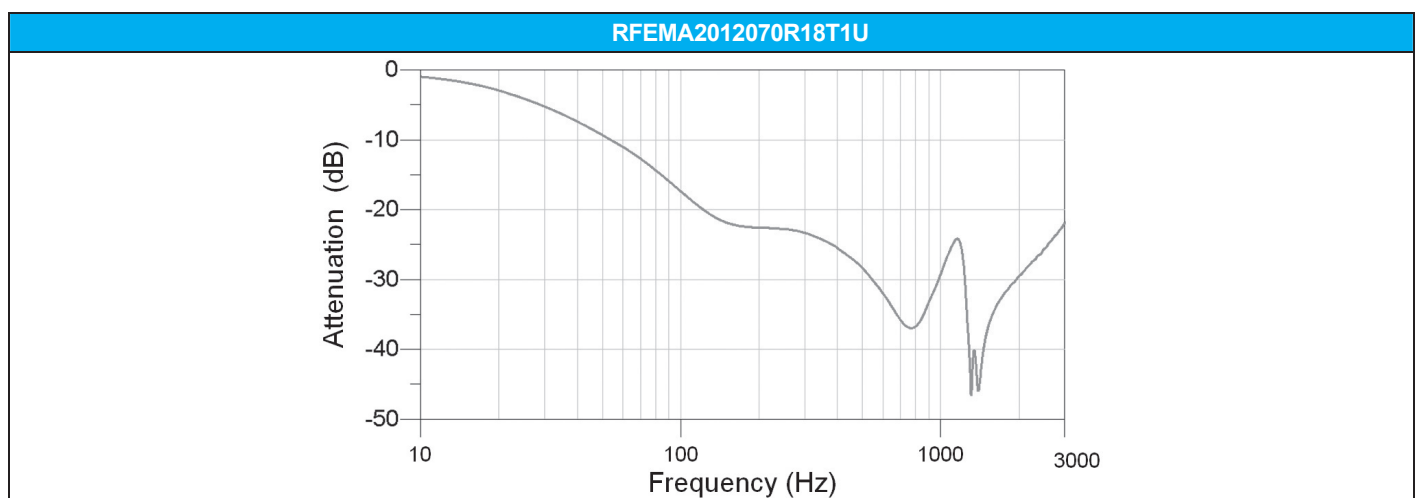

■ For more information, please contact with local sales representative

■ All specifications are subject to change without notice

■ ELECTRICAL SPECIFICATION

Series	Size(mm)		Working Frequency Range	Gain	VSWR	Return Loss
	L	W				
8709	87	9.95	2.4~2.5 GHz	2dBi	<2	<-10dB
			2.4~2.5/5.x GHz	2.4~2.5 GHz:2dBi 5.15~5.85 GHz:3dBi	<2	<-10dB
1313	137.5	13	2.4~2.5 GHz	3dBi	<2	<-10dB
			2.4~2.5/5.x GHz	2.4~2.5 GHz:3dBi 5.15~5.85 GHz:3dBi	<2	<-10dB
1513	157.5	13	2.4~2.5 GHz	3dBi	<2	<-10dB
			2.4~2.5/5.x GHz	2.4~2.5 GHz:3dBi 5.15~5.85 GHz:3dBi	<2	<-10dB
1713	172.5	13	2.4~2.5 GHz	3dBi	<2	<-10dB
			2.4~2.5/5.x GHz	2.4~2.5 GHz:4dBi 5.15~5.85 GHz:5dBi	<2	<-10dB
3913	392	12.5	2.4~2.5 GHz	9dBi	<2	<-10dB
1310	135.7	10	2.4~2.5 GHz	5dBi	<2	<-10dB
			5.x GHz	5dBi	<2	<-10dB
			2.4~2.5/5.x GHz	3dBi~4dBi	<2	<-10dB
			LTE	3dBi	<2	<-10dB
1413	148.5	13	2.4~2.5 GHz	3dBi	<2	<-10dB
			5.x GHz	3dBi	<2	<-10dB
			2.4~2.5/5.x GHz	3dBi	<2	<-10dB
			LTE	3dBi	<2	<-10dB
2213	217.1	13	2.4~2.5 GHz	6dBi	<2	<-10dB
			2.4~2.5/5.x GHz	7dBi	<2	<-10dB
			5.x GHz	7dBi	<2	<-10dB
			LTE	5dBi	<2	<-10dB
2220	220	20	2.4 GHz	5dBi	<2	<-10dB
			5.x GHz	5dBi	<2	<-10dB
			2.4~2.5 GHz	7dBi	<2	<-10dB
2520	25	20	2.4 GHz	5~7dBi	<2	<-10dB
			5.x GHz	7dBi	<2	<-10dB
			2.4~2.5 GHz(High Gain)	7dBi	<2	<-10dB

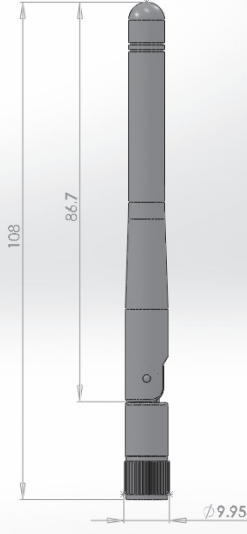
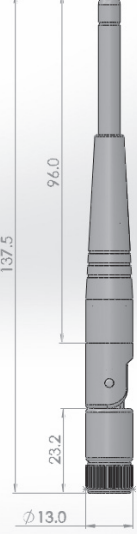
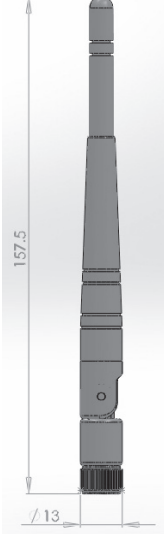
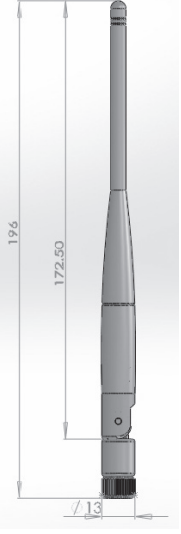
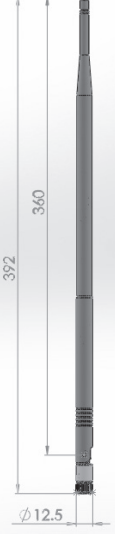
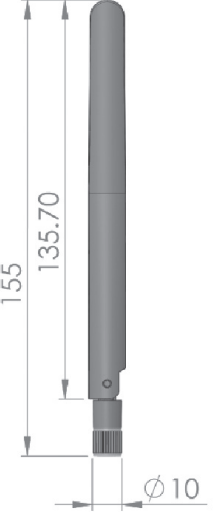
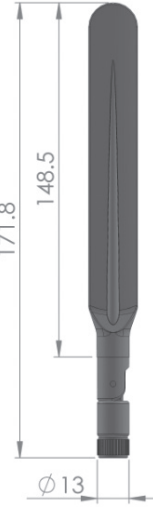
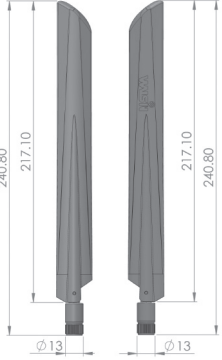
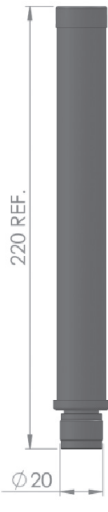
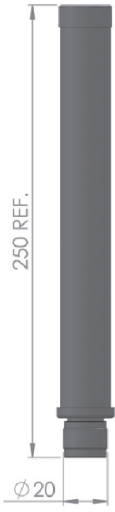
8709	1313	1513	1713	3913
 <p>108 86.7 Ø9.95</p>	 <p>137.5 96.0 23.2 Ø13.0</p>	 <p>157.5 /13</p>	 <p>194 172.50 /13</p>	 <p>392 360 Ø12.5</p>
1310	1413	2213	2220	2520
 <p>155 135.70 Ø10</p>	 <p>171.8 148.5 Ø13</p>	 <p>240.80 217.10 Ø13 217.10 240.80 Ø13</p>	 <p>220 REF. Ø20</p>	 <p>250 REF. Ø20</p>

■ ELECTRICAL SPECIFICATION

Series	Size(mm)		Working Frequency Range	Gain	VSWR	Return Loss
	L	W				
8709	87	9.95	2.4~2.5 GHz	2dBi	<2	<-10dB
			2.4~2.5/5.x GHz	2.4~2.5 GHz:2dBi 5.15~5.85 GHz:3dBi	<2	<-10dB
1313	137.5	13	2.4~2.5 GHz	3dBi	<2	<-10dB
			2.4~2.5/5.x GHz	2.4~2.5 GHz:3dBi 5.15~5.85 GHz:3dBi	<2	<-10dB
1513	157.5	13	2.4~2.5 GHz	3dBi	<2	<-10dB
			2.4~2.5/5.x GHz	2.4~2.5 GHz:3dBi 5.15~5.85 GHz:3dBi	<2	<-10dB
1713	172.5	13	2.4~2.5 GHz	3dBi	<2	<-10dB
			2.4~2.5/5.x GHz	2.4~2.5 GHz:4dBi 5.15~5.85 GHz:5dBi	<2	<-10dB
1310	135.7	10	2.4~2.5 GHz	5dBi	<2	<-10dB
			5.x GHz	5dBi	<2	<-10dB
			2.4~2.5/5.x GHz	3dBi~4dBi	<2	<-10dB
			LTE	3dBi	<2	<-10dB

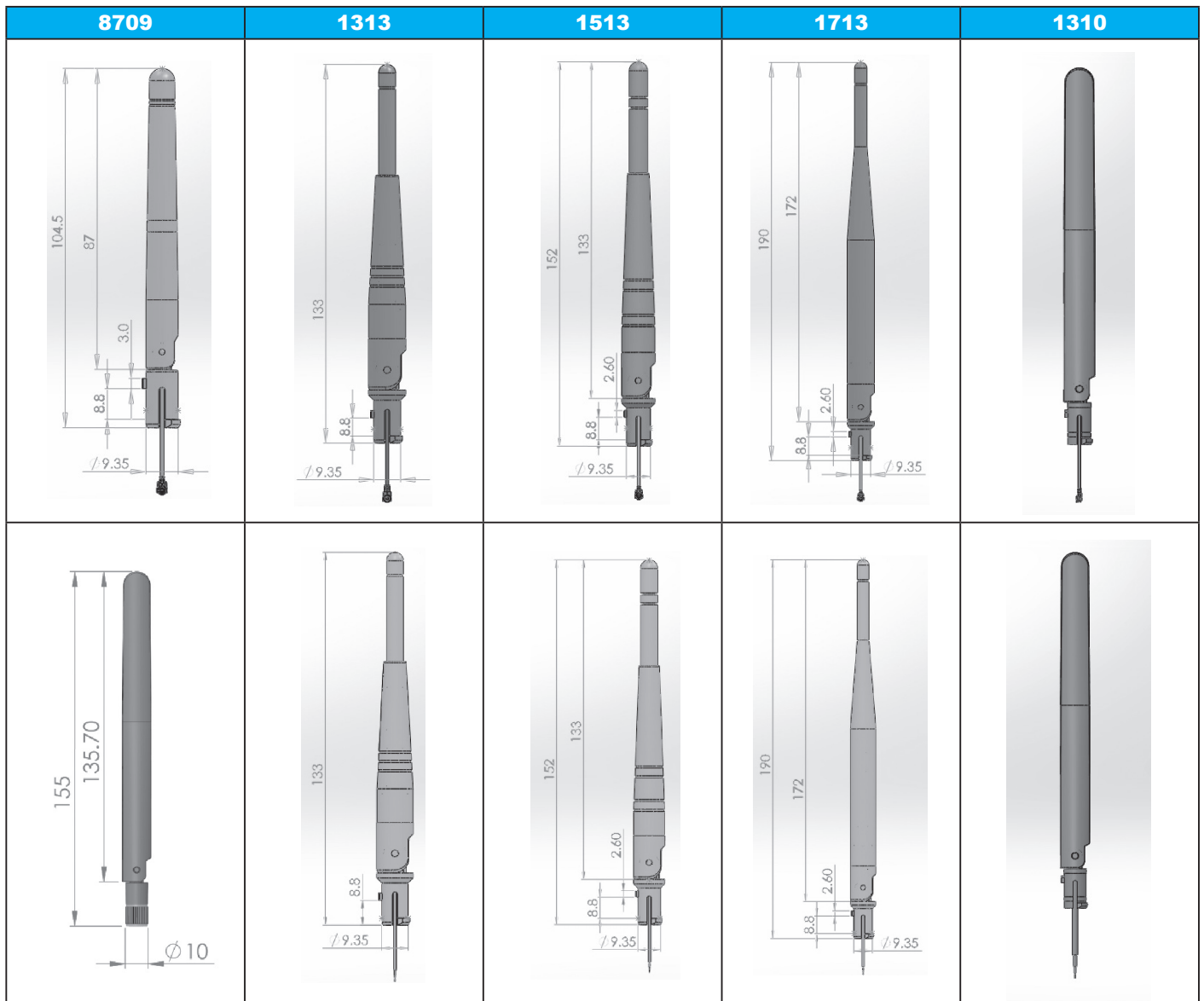

■ ELECTRICAL SPECIFICATION

Series	Connector 1	Connector 2	Wire Diameter	Color	L	Working Frequency Range	VSWR
1006	Straight Reverse SMA Jack	IPEX(or Strip & Tin)	Ø1.13/Ø1.37/RG178	Option	Option	DC ~ 6 GHz	2.0
1106	Straight Reverse SMA Jack	IPEX(or Strip & Tin)	Ø1.13/Ø1.37/RG178	Option	Option	DC ~ 6 GHz	2.0
1613	R/A Reverse SMA Jack	IPEX(or Strip & Tin)	Ø1.13/Ø1.37/RG178	Option	Option	DC ~ 6 GHz	2.0
0403	IPEX	IPEX(or Strip & Tin)	Ø0.81/Ø1.13/Ø1.37/RG178	Option	Option	DC ~ 6 GHz	2.0
0202	IPEX III	IPEX(or Strip & Tin)	Ø0.81	Option	Option	DC ~ 6 GHz	2.0
xxxx	Strip & Tin	Strip & Tin	Ø0.81/Ø1.13/Ø1.37/RG178	Option	Option	DC ~ 6 GHz	2.0
1015	N Jack	MMCX(or Strip & Tin)	RG316	Option	Option	DC ~ 6 GHz	2.0

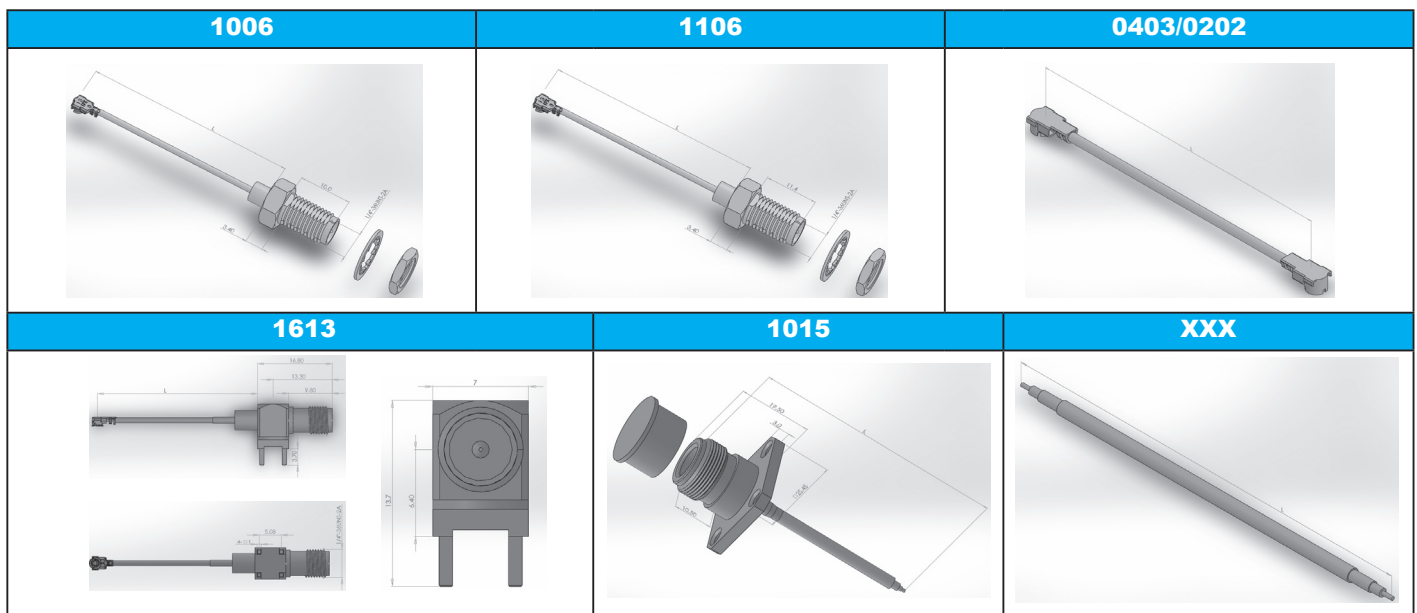

PCB Antenna

■ ELECTRICAL SPECIFICATION

Series	PCB Size(mm)		Cable Length(mm) L	Working Frequency Range	Gain	VSWR	Return Loss
	L	w					
2313	23	13	Option	5 GHz	3dBi	<2	<-10dB
4305	43	5	Option	2.4~2.5 GHz	2dBi	<2	<-10dB
2010	20.1	10	Option	5 GHz	3dBi	<2	<-10dB
5010	50	10	Option	2.4~2.5 GHz	3dBi	<2	<-10dB
4308	43	8.3	Option	2.4~2.5/5.x GHz	2.4~2.5 GHz:2dBi 5.x GHz:3dBi	<2	<-10dB
4606	46.5	6	Option	2.4~2.5 GHz	2dBi	<2	<-10dB

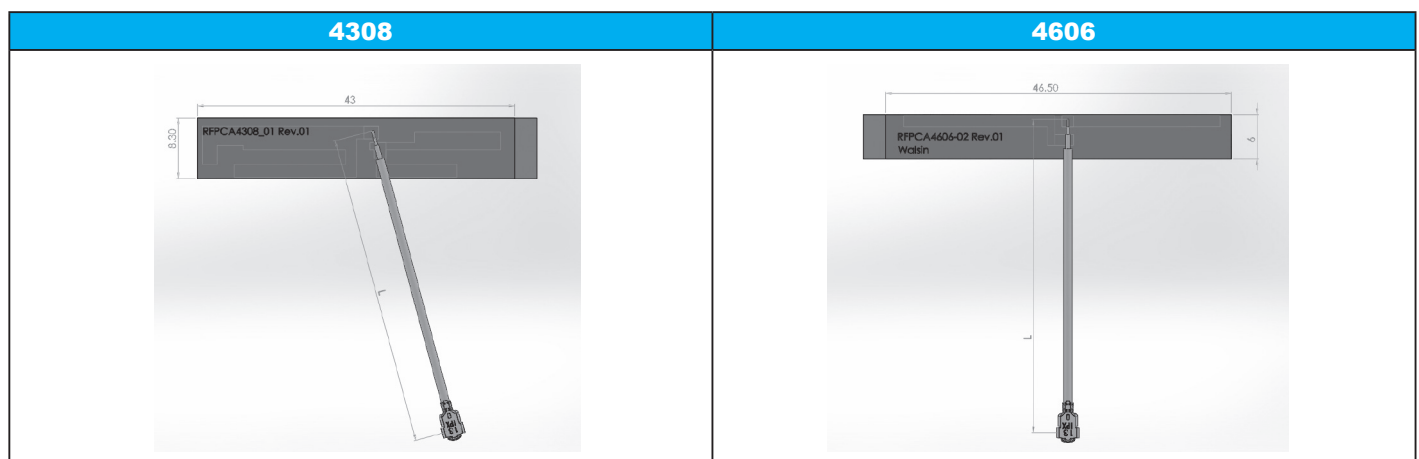
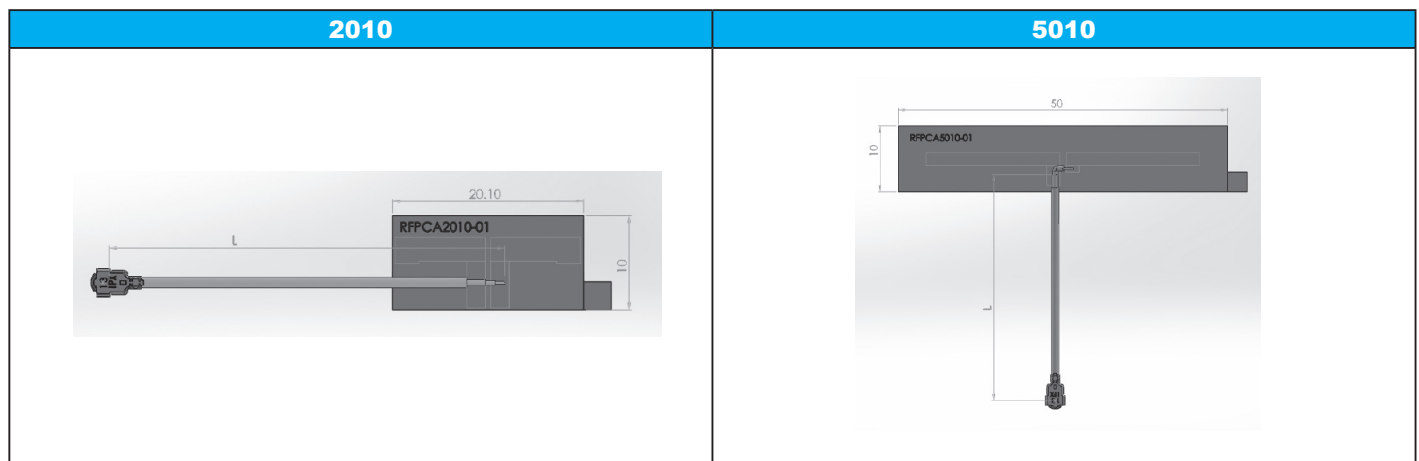
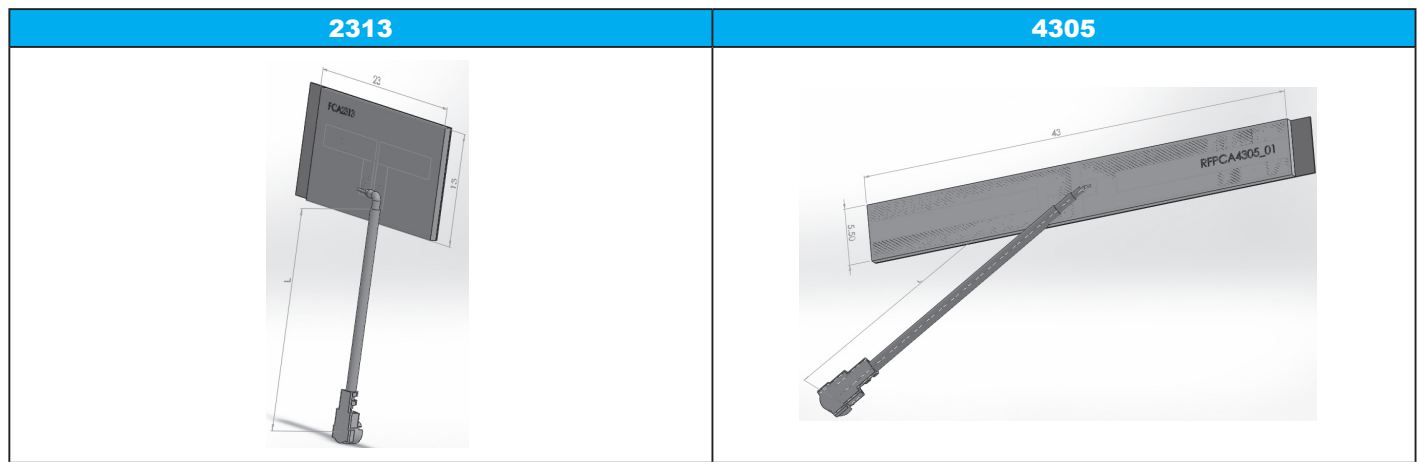

FPA Antenna

■ ELECTRICAL SPECIFICATION

Series	PCB Size(mm)		Cable Length(mm) L	Working Frequency Range	Gain	VSWR	Return Loss
	L	w					
3025	30.3	25.3	Option	2.4~2.5 GHz	3dBi	<2	<-10dB
3225	32.6	25	Option	2.4~2.5 GHz	2dBi	<2	<-10dB
3226	32.35	26	Option	2.4~2.5 / 5.x GHz	3dBi	<2	<-10dB
4305	43	5.5	Option	2.4~2.5 GHz	3dBi	<2	<-10dB

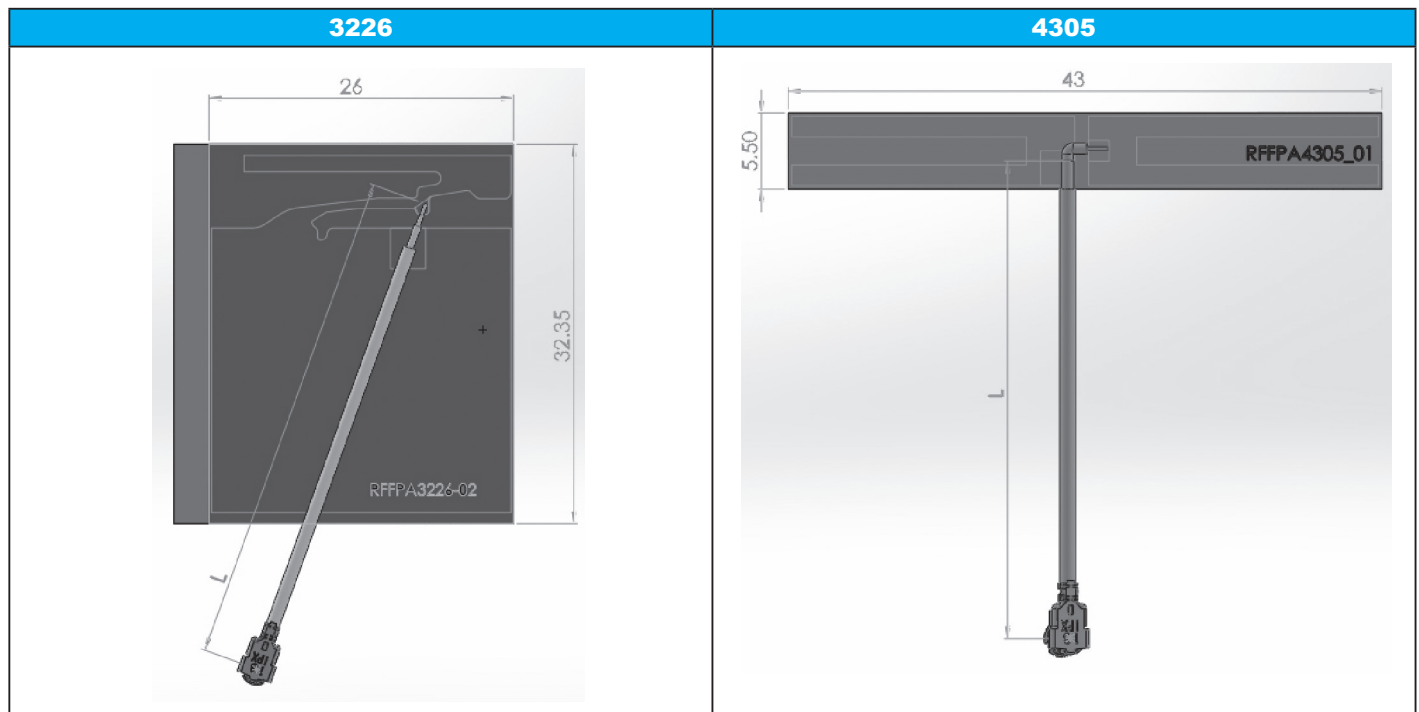
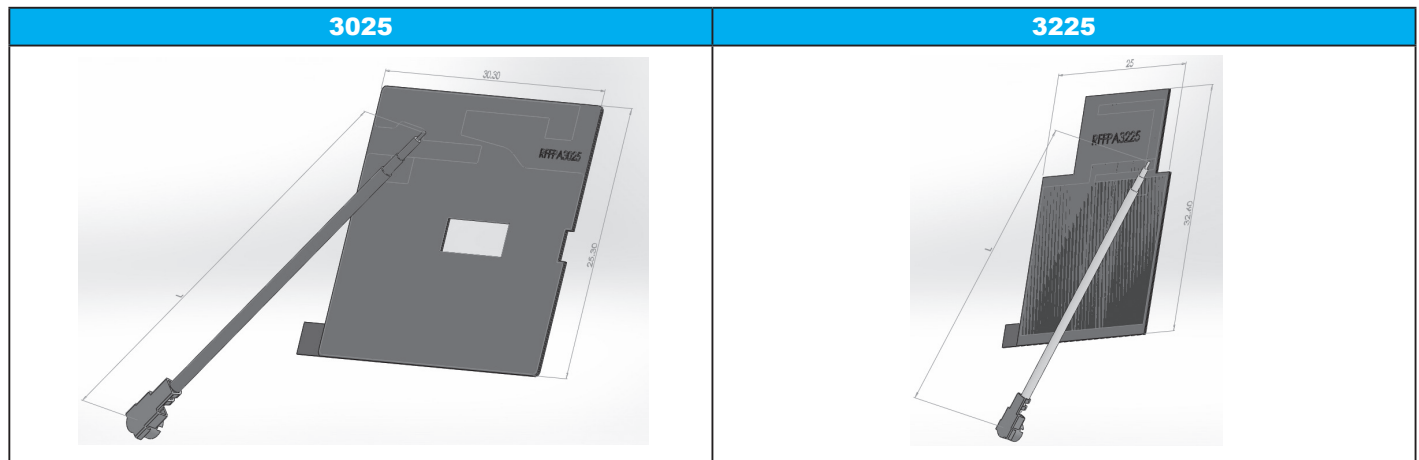

Metal Antenna

■ ELECTRICAL SPECIFICATION

Series	PCB Size(mm)		Cable Length(mm) L	Working Frequency Range	Gain	VSWR	Return Loss
	L	w					
3109	31	9	Option	2.4~2.5/5.x GHz	2.4~2.5 GHz:2 dBi 5.x GHz:2 dBi	<2	<-10dB
2107	21.5	7.1	None	2.4~2.5 GHz	3 dBi	<2	<-10dB
2807	28.6	7.9	Option	2.4~2.5 GHz	3 dBi	<2	<-10dB
3407	34	7.5	Option	2.4~2.5 GHz	3 dBi	<2	<-10dB

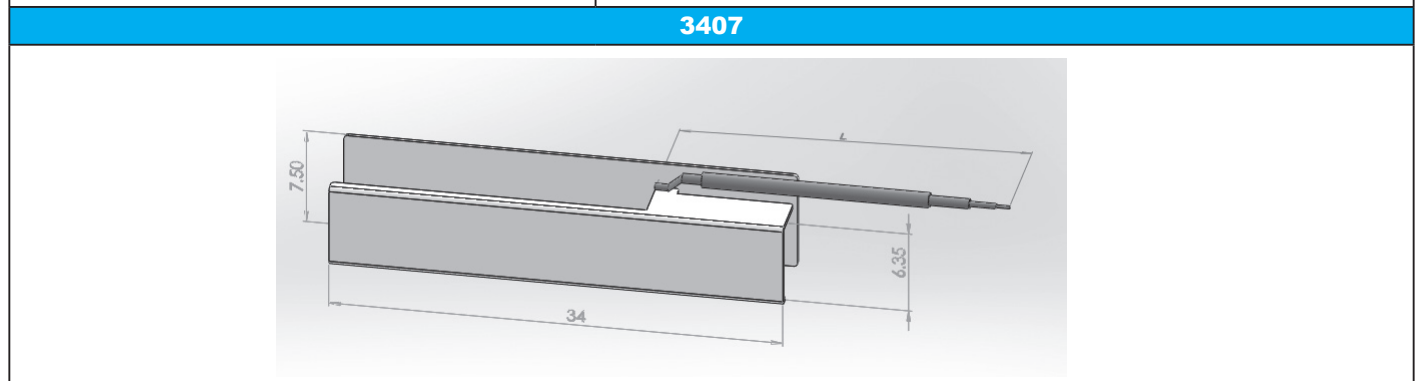
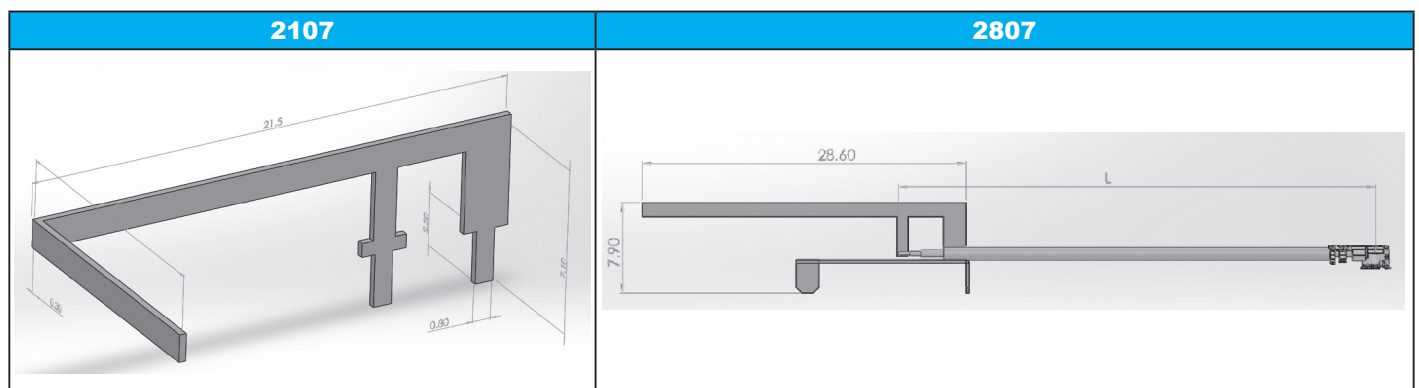
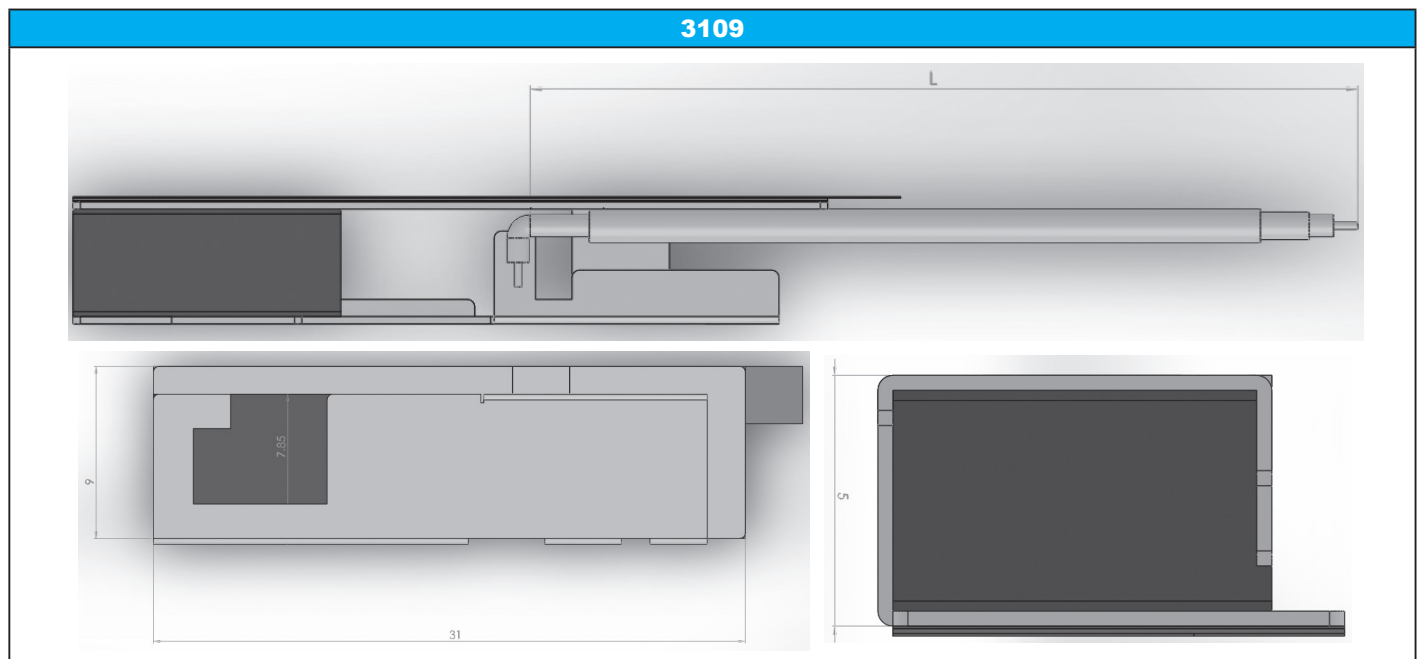

NFC

■ ELECTRICAL SPECIFICATION

Series	Size(mm)		Ls	Rs	Q
	L	w			
5030	50	30	1.62±0.1μH	0.66±0.15Ω	15.42±2.5(1MHz)
5040	50	40	1.89±0.1μH	0.76±0.15Ω	15.62±2.5(1MHz)
6040	60	40	2.37±0.1μH	0.85±0.15Ω	17.5±2.5(1MHz)

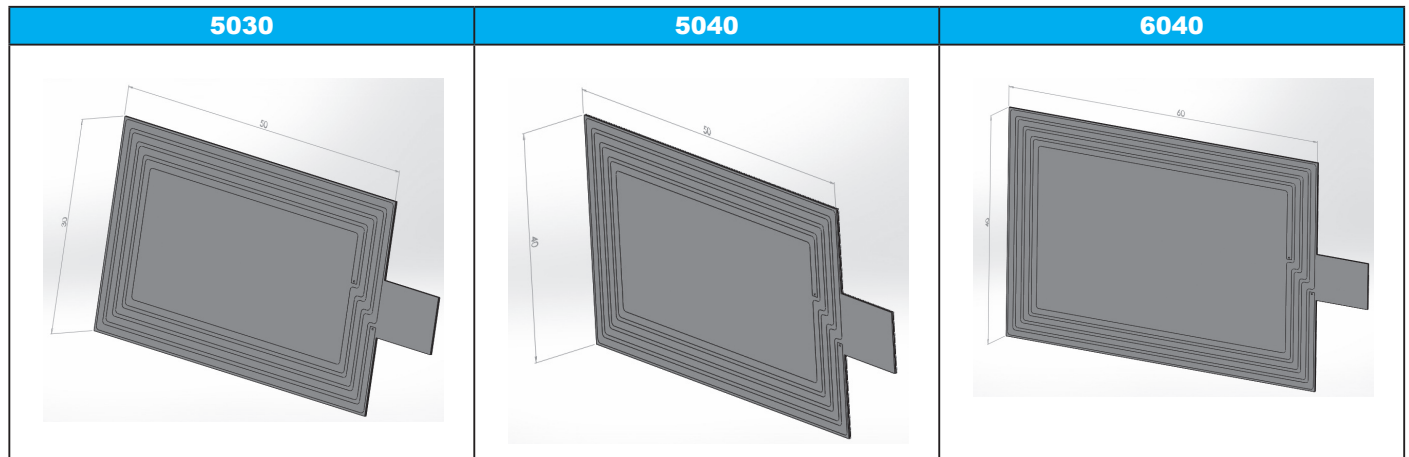

WPC & WNC

TYPE	Series	Size(mm)		Ls		Rs		Q	
		L	w	NFC	WPC	NFC	WPC	NFC	WPC
WPC	4832	48	32	1.35±0.1μH		0.3±0.15Ω		28.3±2.5(1MHz)	
WNC	6060	60	60	NFC	2.11±0.1μH	NFC	0.572±0.15Ω	NFC	37.2±2.5(1MHz)
				WPC	18.69±0.1μH	WPC	0.837±0.15Ω	WPC	14.03±2.5(1MHz)

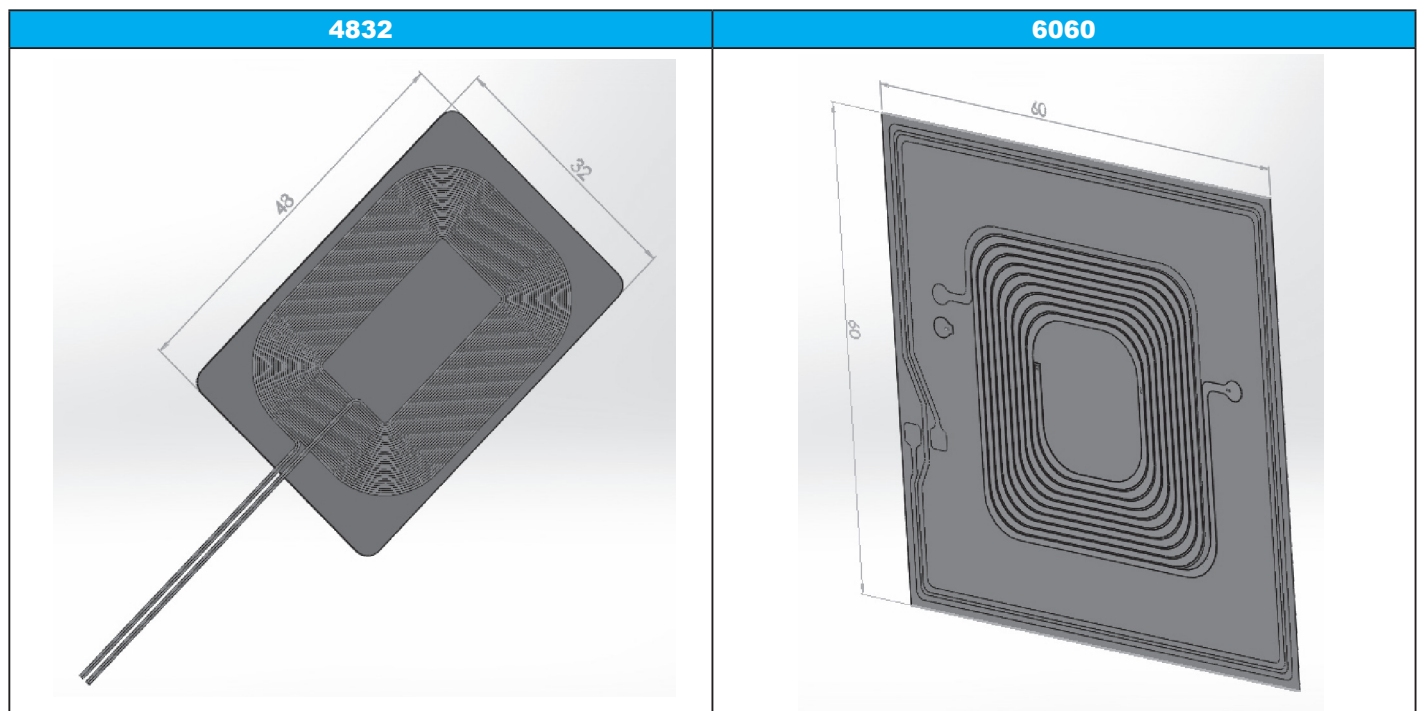

Connector

■ ELECTRICAL SPECIFICATION

Series	Size(mm)		Ls	Rs
	L	w		
1612	16.8	12.3	DC ~ 6 GHz	2.0
0703	7.5	3.3	DC ~ 6 GHz	2.0
1308	13.3	8	DC ~ 6 GHz	2.0

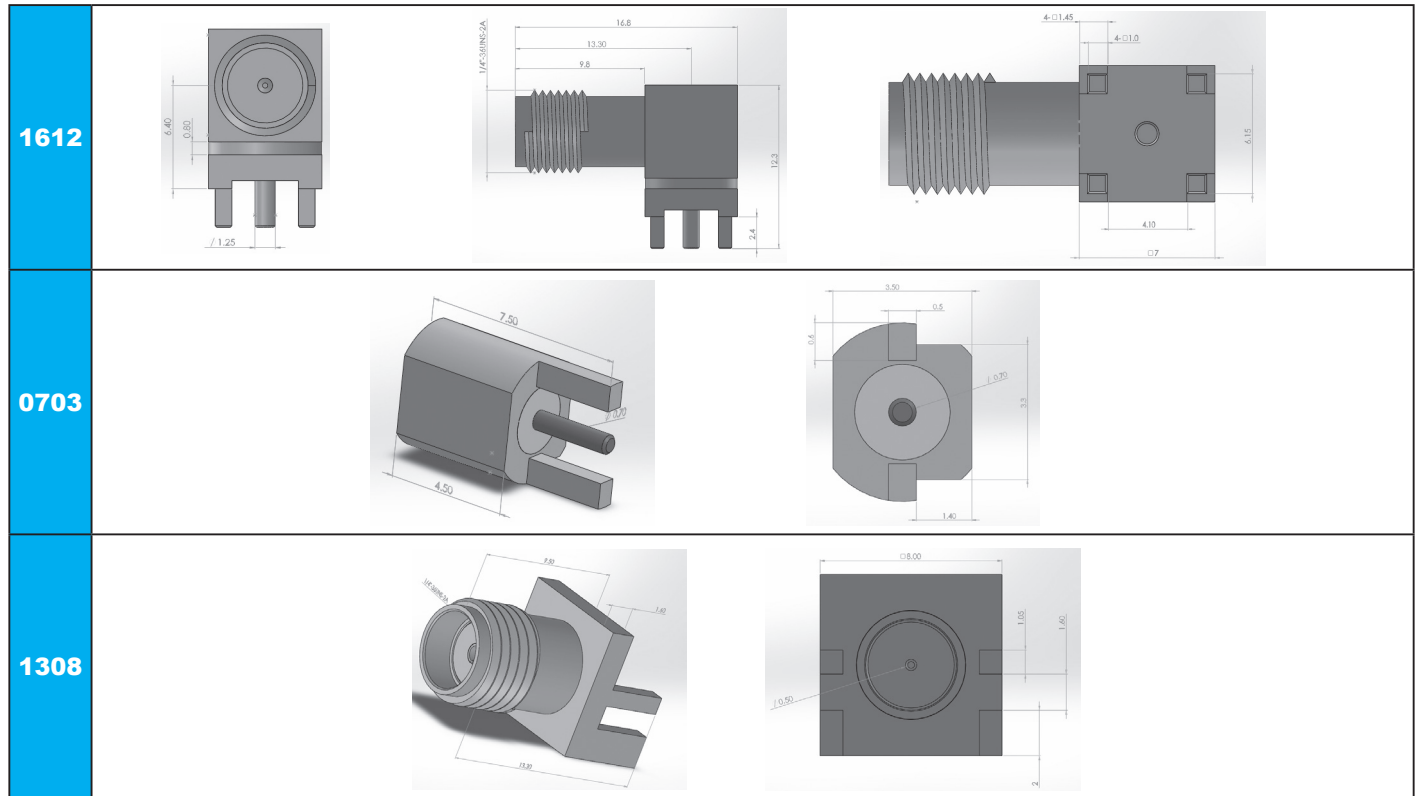

- Antenna Passive Measurement: Efficiency / 3D Pattern @400MHz ~ 6GHz
- Active Measurement: TRP & TIS Measurement for GSM/WCDMA/
TD-CDMA/TDD-LTE/FDD-LTE

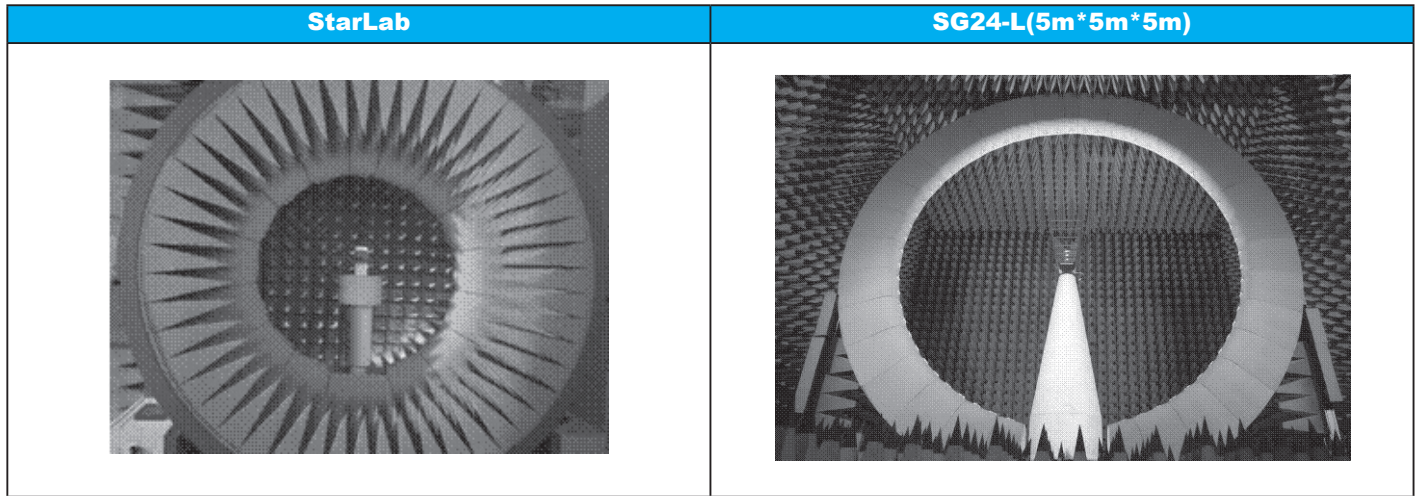

■ 2D Antenna Lab (Throughput Test)

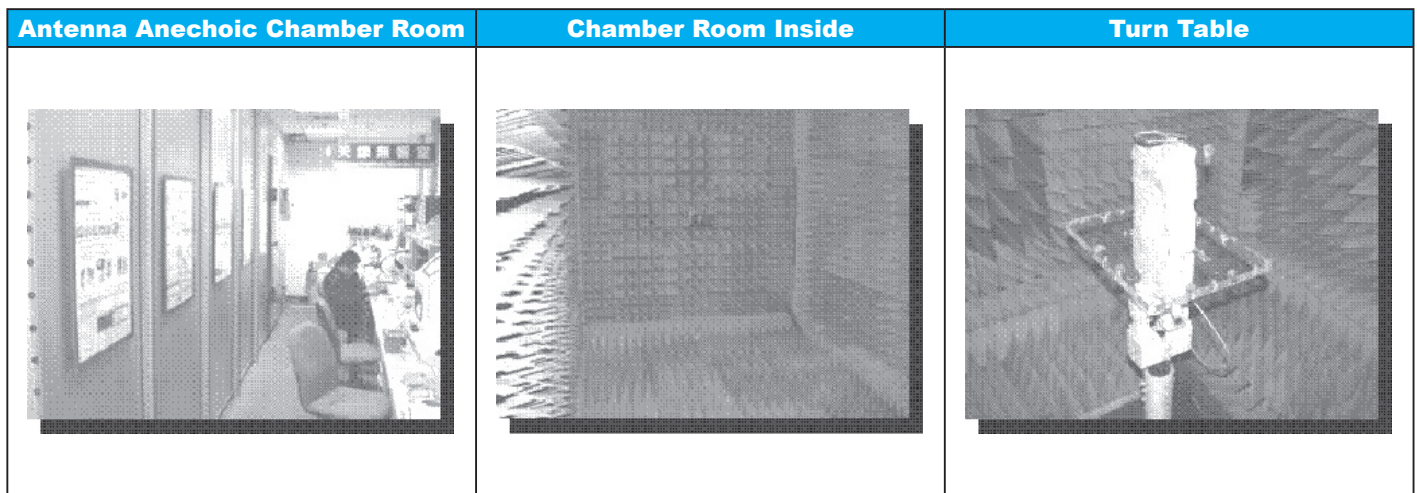

■ FIME EMVCo/ISO10373-6 / NFC Forum

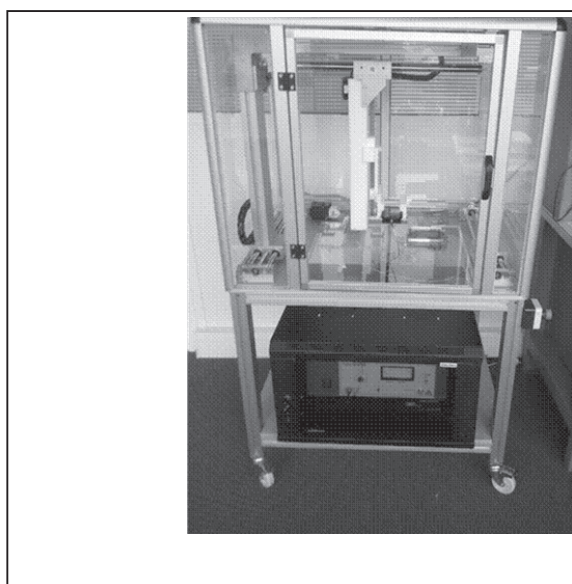

■ Comprion (NFC Forum)



Taiwan - Yang-Mei Plant / Sales Office

Walsin Technology Corporation
566-1, Kao-Shi Road, Yang-Mei,
Tao-Yuan, Taiwan
Tel: +886-3-475-8711
Fax: +886-3-475-7130
Email: info@passivecomponent.com

Germany - Munich Sales Office

Walsin Technology Corporation Europe
Stefan-George-Ring 29,
81929 Munich, Germany
Tel: +49-(0)89-9308-6475
Fax: +49-(0)89-9308-6464
Email: aw@passivecomponent.com

China - Dalang Plant / Sales Office

Dongguan Walsin Tech. Electronics CO., Ltd.
Xiniupo Administrative Zone,
Dalang Town, Dongguan City,
Guangdong Province 523799
Tel: +86-769-831-15168
Fax: +86-769-831-15188
Email: rederschang@passivecomponent.com

Singapore - Sales Office

WTC Singapore Sales Office, Singapore
8 Ubi View #04-01
Serial System Building
Singapore 408554
Tel: +65-6896-3877
Fax: +65-6861-3381
Email: michaelchee@sg.passivecomponent.com

China - Suzhou Plant / Sales Office

Suzhou Walsin Technology Electronics Co., Ltd.
No. 369, Changyan Street,
Suzhou Industrial Park,
Jiangsu Province 215126
Tel: +86-512-628-36888
Fax: +86-512-628-37888
Email: rederschang@passivecomponent.com

United States - West Coast Sales Office

Walsin Technology Corporation, USA
Contact: FC Tseng
Tel: +1-214-708-5182
E-mail: fctseng@passivecomponent.com

China - Guangzhou Plant / Sales Office

Pan Overseas (Guangzhou) Electronic Co., Ltd.
No. 277, Hong Ming Road, Eastern Section,
Guangzhou Economic and Technology
Development Zone, China
Tel: +86-20-8223-7476
Fax: +86-20-8223-7475
Email: rederschang@passivecomponent.com

JAPAN - Sales Office

WTC Japan Sales Office, Japan
8-4-17, Fukayanaka,
Ayase-shi, Kanagawa,
252-1107, Japan.
Tel: +81-467-71-0884
Fax: +81-467-71-0910
Email: tsakano@kamaya.co.jp



Walsin Technology Corporation

TAIWAN - WTC Yang-Mei Plant / Sales Office

Walsin Technology Corporation

566-1, Kao-Shi Road, Yang-Mei, Tao-Yuan, Taiwan

Tel: +886-3-475-8711

Fax: +886-3-475-7130

Email: info@passivecomponent.com



February 2015