

6000 Series Buccaneer – circular connectors that combine the ease of use of a push/pull coupling mechanism with proven environmental sealing. Available with metal or plastic bodies, the range supports both data (USB and Ethernet), signal and mains power. Designed and independently tested to IP66, IP68 & IP69K standards, they are ideal for applications where ingress of dust and water must be avoided and where ease of connection, space and appearance are important considerations.

- Secure, quick connector mating and release
- 30° twist locking
Tamperproof lock prevents accidental un-mating
- IP66, IP68 and IP69K when mated
Suitable for a wide range of dust and water borne environments
- All plastic body version; UL94-V0 rated, UV stable, halogen free
Light-weight, self-extinguishing material suitable for long-term outdoor use
- Flex, flex in-line & panel mount body styles, with sealing caps
Complete family of products maintain sealing integrity in all styles
- Polarisation and visual alignment features
Aids the correct mating of connectors
- 2 to 22 poles – up to 16A, 277V rated
Suitable for mains power to signal applications
- ‘Scoop proof’ contacts
Prevents damage through mis-mating – ideal for ‘blind mating’ applications
- cULus, UL, VDE
Internationally recognised certification
- Screw, Crimp and Solder terminations available



BUCCANEER FOR POWER
6000 Series Buccaneer

Thermo Plastic



Flex Cable Connector



PXP6010

- Mates with In-Line Flex or Panel Mounting versions PXP6011 & PXP6012
- Push/pull locking ring with 30° twist locking
- Pin or socket versions
- Leading earth on 3 pole connectors
- 2, 3, 8, 16 & 22 pole
- Screw, solder and crimp termination

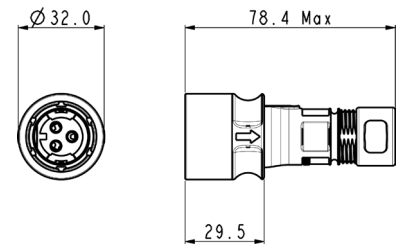

Poles	Termination	Pin Contacts	Socket Contacts	Contacts
2	Screw	PXP6010/02P/ST	PXP6010/02S/ST	Supplied Fitted
2	Crimp / Solder	PXP6010/02P/CR	PXP6010/02S/CR	Contacts Required
3	Screw	PXP6010/03P/ST	PXP6010/03S/ST	Supplied Fitted
3	Crimp / Solder	PXP6010/03P/CR	PXP6010/03S/CR	Contacts Required
8	Crimp / Solder	PXP6010/08P/CR	PXP6010/08S/CR	Contacts Required
16	Crimp / Solder	PXP6010/16P/CR	PXP6010/16S/CR	Contacts Required
22	Crimp / Solder	PXP6010/22P/CR	PXP6010/22S/CR	Contacts Required

In-line Flex Cable Connector



PXP6011

- Mates with Flex Cable connector PXP6010
- For in-line cable connection
- Pin or socket versions
- Leading earth on 3 pole connectors
- 2, 3, 8, 16 and 22 pole
- Screw, solder and crimp termination

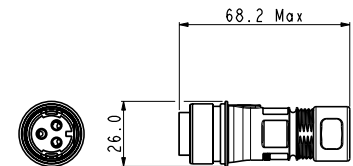

Poles	Termination	Pin Contacts	Socket Contacts	Contacts
2	Screw	PXP6011/02P/ST	PXP6011/02S/ST	Supplied Fitted
2	Crimp / Solder	PXP6011/02P/CR	PXP6011/02S/CR	Contacts Required
3	Screw	PXP6011/03P/ST	PXP6011/03S/ST	Supplied Fitted
3	Crimp / Solder	PXP6011/03P/CR	PXP6011/03S/CR	Contacts Required
8	Crimp / Solder	PXP6011/08P/CR	PXP6011/08S/CR	Contacts Required
16	Crimp / Solder	PXP6011/16P/CR	PXP6011/16S/CR	Contacts Required
22	Crimp / Solder	PXP6011/22P/CR	PXP6011/22S/CR	Contacts Required

Front Panel Mounting Connector



PXP6012

- Mates with Flex Cable connectors PXP6010
- Front panel mounting
- Single hole fixing
- Pin or socket versions
- Leading earth on 3 pole connectors
- 2, 3, 8, 16 and 22 pole
- Screw, solder and crimp termination

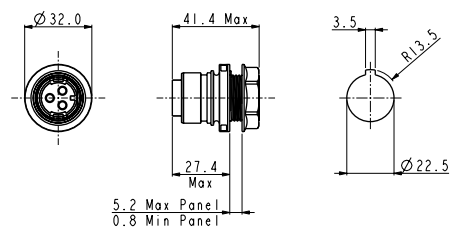

Poles	Termination	Pin Contacts	Socket Contacts	Contacts
2	Screw	PXP6012/02P/ST	PXP6012/02S/ST	Supplied Fitted
2	Crimp / Solder	PXP6012/02P/CR	PXP6012/02S/CR	Contacts Required
3	Screw	PXP6012/03P/ST	PXP6012/03S/ST	Supplied Fitted
3	Crimp / Solder	PXP6012/03P/CR	PXP6012/03S/CR	Contacts Required
8	Crimp / Solder	PXP6012/08P/CR	PXP6012/08S/CR	Contacts Required
16	Crimp / Solder	PXP6012/16P/CR	PXP6012/16S/CR	Contacts Required
22	Crimp / Solder	PXP6012/22P/CR	PXP6012/22S/CR	Contacts Required

BUCCANEER FOR POWER
6000 Series Buccaneer

Metal Version



Flex Cable Connector



PXM6010

- Mates with In-Line Flex or Panel Mounting versions PXM6011 and PXM6012
- Push/pull locking ring with 30° twist locking
- Pin or socket versions
- Leading earth on 3 pole connectors
- 2, 3, 8, 16 and 22 pole
- Screw, solder and crimp termination
- Cable braid termination accessory option, add /SNSuffix

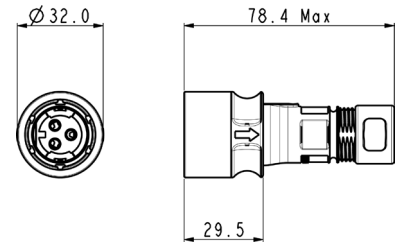

Poles	Termination	Pin Contacts	Socket Contacts	Contacts
2	Screw	PXM6010/02P/ST	PXM6010/02S/ST	Supplied Fitted
2	Crimp / Solder	PXM6010/02P/CR	PXM6010/02S/CR	Contacts Required
3	Screw	PXM6010/03P/ST	PXM6010/03S/ST	Supplied Fitted
3	Crimp / Solder	PXM6010/03P/CR	PXM6010/03S/CR	Contacts Required
8	Crimp / Solder	PXM6010/08P/CR	PXM6010/08S/CR	Contacts Required
16	Crimp / Solder	PXM6010/16P/CR	PXM6010/16S/CR	Contacts Required
22	Crimp / Solder	PXM6010/22P/CR	PXM6010/22S/CR	Contacts Required

In-line Flex Cable Connector



PXM6011

- Mates with Flex Cable connector PXM6010
- For in-line cable connection
- Pin or socket versions
- Leading earth on 3 pole connectors
- 2, 3, 8, 16 and 22 pole
- Screw, solder and crimp termination
- Cable braid termination accessory option, add /SNSuffix

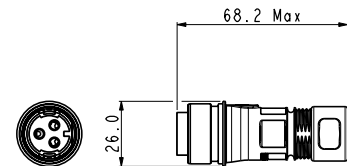

Poles	Termination	Pin Contacts	Socket Contacts	Contacts
2	Screw	PXM6011/02P/ST	PXM6011/02S/ST	Supplied Fitted
2	Crimp / Solder	PXM6011/02P/CR	PXM6011/02S/CR	Contacts Required
3	Screw	PXM6011/03P/ST	PXM6011/03S/ST	Supplied Fitted
3	Crimp / Solder	PXM6011/03P/CR	PXM6011/03S/CR	Contacts Required
8	Crimp / Solder	PXM6011/08P/CR	PXM6011/08S/CR	Contacts Required
16	Crimp / Solder	PXM6011/16P/CR	PXM6011/16S/CR	Contacts Required
22	Crimp / Solder	PXM6011/22P/CR	PXM6011/22S/CR	Contacts Required

Front Panel Mounting Connector



PXM6012

- Mates with Flex Cable connectors PXM6010
- Front panel mounting
- Single hole fixing
- Pin or socket versions
- Leading earth on 3 pole connectors
- 2, 3, 8, 16 and 22 pole
- Screw, solder and crimp termination

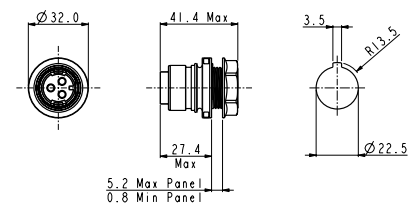

Poles	Termination	Pin Contacts	Socket Contacts	Contacts
2	Screw	PXM6012/02P/ST	PXM6012/02S/ST	Supplied Fitted
2	Crimp / Solder	PXM6012/02P/CR	PXM6012/02S/CR	Contacts Required
3	Screw	PXM6012/03P/ST	PXM6012/03S/ST	Supplied Fitted
3	Crimp / Solder	PXM6012/03P/CR	PXM6012/03S/CR	Contacts Required
8	Crimp / Solder	PXM6012/08P/CR	PXM6012/08S/CR	Contacts Required
16	Crimp / Solder	PXM6012/16P/CR	PXM6012/16S/CR	Contacts Required
22	Crimp / Solder	PXM6012/22P/CR	PXM6012/22S/CR	Contacts Required

Crimp / Solder Contacts			Contacts (for 2 & 3 pole) (Supplied in packs of 10)	Crimp	Solder
 <p>2, 3, 8, 16 & 22 pole contacts</p>	<ul style="list-style-type: none"> ○ Gold Plated ○ Current ratings: 2 & 3 pole : 16A 8 pole : 10A 16 pole : 3A 22 pole : 2A 		Pins	SA3545/P	SA3624/P
			Sockets	SA3545/S	SA3624/S
			Contacts (for 8 pole) (Supplied in packs of 10)	Crimp	Solder
			Pins	SA3544/P	SA3623/P
			Sockets	SA3544/S	SA3623/S
			Contacts (for 16 & 22 pole) (Supplied in packs of 10)	Crimp	Solder
			Pins	SA3542/P	SA3622/P
			Sockets	SA3542/S	SA3622/S

Crimp Tooling			Crimp Tooling	
 <p>PNo 14232</p>	<ul style="list-style-type: none"> ○ Crimp Tools for 2, 3, 8, 16 and 22 pole crimp contacts 		Crimp Tool (2 & 3 pole)	PNo.14232
			Positioner (2 & 3 pole)	PNo.14232/2/SP
			Crimp Tool (8, 16 & 22 pole)	PNo.14025
			Positioner (8 pole)	PNo.15021/SP
			Positioner (16 & 22 pole)	PNo.15019/SP

Extraction Tool			Extraction Tools	
	<ul style="list-style-type: none"> ○ Extraction Tool for 2, 3, 8, 16 and 22 pole contacts 		Extraction Tool (2 & 3 pole)	PNo.14946/SP
			Extraction Tool (8 pole)	PNo.14945/SP
			Extraction Tool (16 & 22 pole)	PNo.14944/SP

Contact Carrier Removal Tool			Tools	
 <p>PNo 14917</p>	<ul style="list-style-type: none"> ○ For removal of all contact carriers 		Contact carrier removal tool (all poles)	PNo. 14917/SP

BUCCANEER FOR POWER
6000 Series Buccaneer

Accessories



Sealing Caps



PXM6083 PXM6082 PXM6081

- Maintains IP Rating of Unmated Connectors
- PXM6081: Fits PXM6010 (Flex Connector)
- PXM6082: Fits PXM6011 (Flex In-Line Connector)
- PXM6083: Fits PXM6012 (Panel Connector)

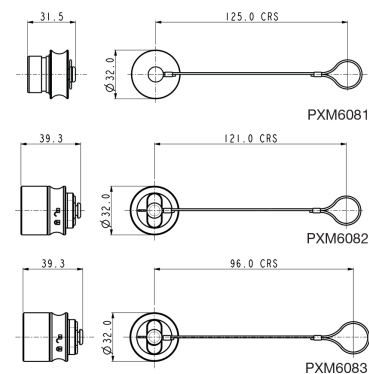

Cable Gland Pack



PXP6088

- Pack of all cable glands to suit cable ranges from 4.0 to 10.0mm diameter

Cable Braid Termination Option



PXM6090

- For cable braid termination
- Supplied with ty-rap

BUCCANEER FOR POWER
6000 Series Buccaneer

Part No System



PXX	6XXX	/	XX	/	X	/	XX	/	XXXX	/	XX
Series Designation	Series / Body Style	No. of Contacts	Contacts Type	Terminations	Cable Entry Size	Cable Brand Termination Accessory					
PXM= Metal Series PXP= Plastic Series	Body Styles 6010 = Flex 6011 = Flex In-Line 6012 = Panel	No. of Contacts 02 = 2 Pole 03 = 3 Pole 08 = 8 Pole 16 = 16 Pole 22 = 22 Pole	Contacts Type P = Pin S = Socket	Contacts Termination CR = Contacts Required ST = Screw (2 and 3 pole only)	Cable Entry Size (for Flex and Flex In-Line connectors only) 0405 = 4-5mm (Dark Grey) 0507 = 5-7mm (White) 0709 = 7-9mm (Yellow) 0910 = 9-10mm (Light Grey)	Cable Braid Termination Accessory (for Flex and Flex In-Line connectors only) SN if required Blank if not required					

Examples

PXM6010/03P/CR/0507= Flex cable connector, 3 pole, pin contacts with 5 to 7mm cable glands
 PXM6012/03/S/ST= Front panel mounting connector, 3 pole, socket with screw termination

BUCCANEER FOR POWER

6000 Series Buccaneer

Specifications



Electrical:

No. Poles:	2	3	8	16	22
Current Rating: See de-rating curves for further information					
VDE	16A	16A	10A	3A	2A
UL	16A	16A	7A	3A	3A
cUL	11A	11A	4A	1.5A	1.5A
CCC					
Voltage	277V	277V	277V	60V	60V
Rated cable	18 AWG	18 AWG	18 AWG	22 AWG	26 AWG
Contact Resistance:	<10mΩ				
Insulation Resistance:	>10 ⁶ MΩ @500V dc				
AC Breakdown voltage:					
2 pole	>10kV				
3 pole	>8kV				
8 to 22 pole	>5kV				
Operating Temp. Range:	-40°C to +120°C				
Approvals:					
UL (E214972)	UL1977				
cULus (E214972)	C22.2 No.182.3-M1987 (R2009)				
VDE (40039281)	IEC 61984:2009				
CCC (Pending)					

Mechanical:

Locking mechanism	Push/pull with 30° locking Patent applied for
Sealing:	IP66 to En60529:1992+A2:2013 IP68 to En60529:1992+A2:2013 (10m depth for 2 weeks) IP69k to DIN 40050-9
Salt Mist (plastic) :	EN60068-2-52 Test Kb Salt Mist (Cyclic) Marine Severity Level 1
Salt Mist (metal) :	EN60068-2-11 Test Ka Salt Mist
Contact Accommodation:	
2 & 3 pole crimp / solder	14 to 18AWG
2 & 3 pole screw terminals	1.5mm ² max
8 pole crimp / solder	18 to 20AWG
16 pole crimp / solder	22 to 26AWG
22 pole crimp / solder	22 to 26AWG
Cable Acceptance:	4-10mm dia.
Cable retention force (to BS EN61984):	
4 - 9mm dia cable	80N
9 - 10mm dia cable	100N
Terminations:	
2 Pole:	Screw Terminals
3 Pole:	Screw, crimp or solder terminals
8 Pole:	Crimp / Solder Contacts
16 Pole:	Crimp / Solder Contacts
22 Pole:	Crimp / Solder Contacts
Tightening Torques:	
Gland Nut:	1.13Nm (10lb.in)
Panel Nut:	1.7Nm (15lb.in.)
Panel Nut Thread:	M22 x 1.5-6g
Dimensions:	
Diameter: (over coupling ring)	32mm
Diameter: (panel hole cut-out)	22.5mm

Materials:

	Plastic	Metal
Body:	PC/ PBT	Brass
Colour:	Grey	Matt silver
Contacts:	Brass, Nickel Plate (Screw and Crimp) Brass, (3A – Gold plated)	Brass, Nickel Plate (Screw and Crimp) Brass, (3A – Gold plated)
O Rings & Gaskets:	Silicone	Silicone
Flammability Rating:	UL94 V-0	-
Halogen free	Yes	-
UV Resistance:	ISO 4892 part 3 cycle 1 (QUV)	-
RoHS	Compliant	Compliant

The thermal properties of the materials used in the construction of a connector limit the current carrying capacity. There are a number of factors that determine the amount of current that can be handled: contact spacing, size of cable, ambient temperature and the heat that is generated by the current passing through the connector.

The maximum current varies with different contact layouts, and because of these factors it is necessary to produce de-rating curves for each pole variant. This de-rating curve is specified in the standard IEC 60512 part 3. De-rating curves are plotted for each contact carrier combination with the current being carried simultaneously by all contacts. These graphs show the heat rise generated as the current is increased.

The red line indicates the direct correlation between current applied and the measured temperature rise within the connector. The dotted blue line shows rated current and the green line is derived by applying a factor of 0.8 to the original plot data to give a de-rating curve. The dashed blue line shows the rated current.

The shaded area under the 0.8 curve shows the permitted operating area, and allows safe current vs ambient temperature characteristics to be determined.

- = tested operating limits
- = de-rated operating limits
- - - = rated current

2 Pole, Metal Body, Crimp Terminal, 18 AWG wire
 current applied through all pins simultaneously

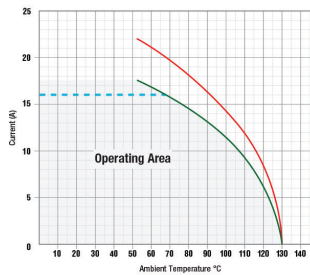

3 Pole, Metal Body, Screw Terminal, 18 AWG wire
 current applied through all pins simultaneously

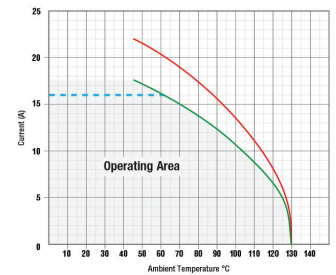

8 Pole, Metal Body, Crimp Terminal, 18 AWG wire
 current applied through all pins simultaneously

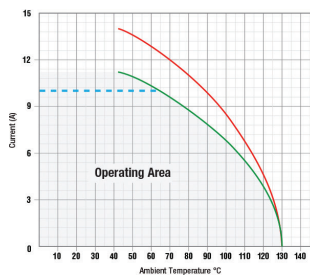

8 Pole, Metal Body, Crimp Terminal, 20 AWG wire
 current applied through all pins simultaneously

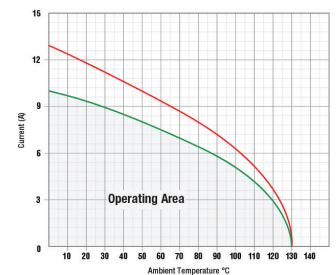

16 Pole, Metal Body, Crimp Terminal, 22 AWG wire
 current applied through all pins simultaneously

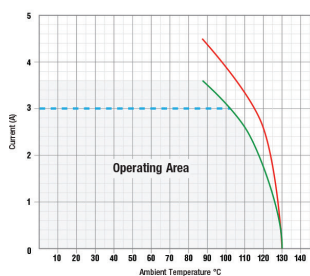

16 Pole, Metal Body, Crimp Terminal, 26 AWG wire
 current applied through all pins simultaneously

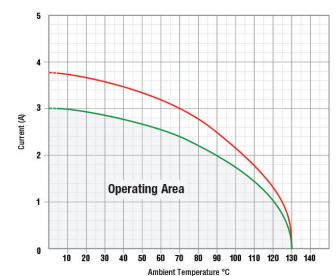

22 Pole, Metal Body, Crimp Terminal, 26 AWG wire
 current applied through all pins simultaneously

