

RECOMMENDED P.C.B HOLE LAYOUT

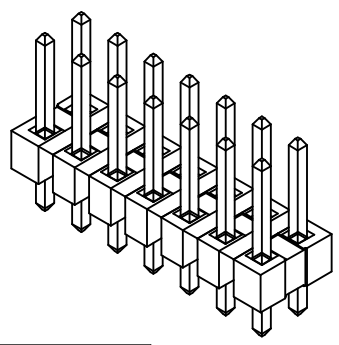
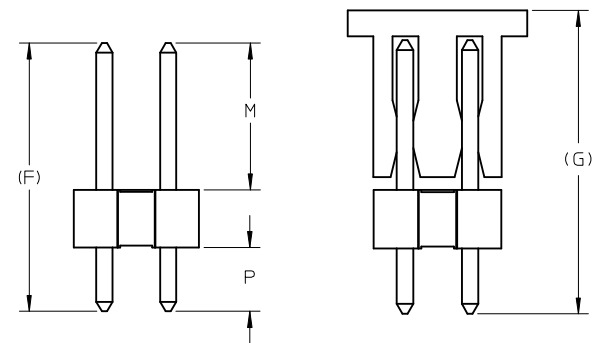
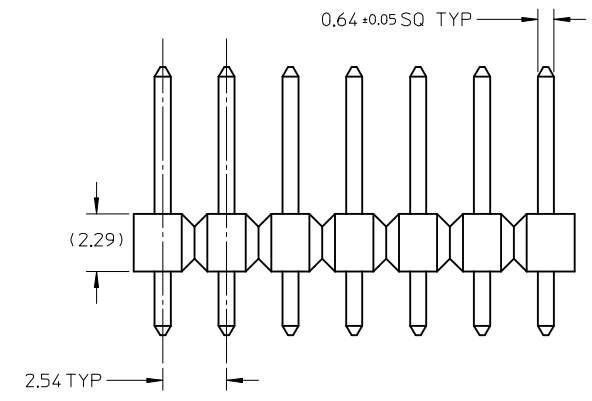

REVISION OF DRAWING MAY BE CHANGED DURING FINAL RELEASED FOR PRODUCTION.

NOTES:

1. MATERIAL:
HSG: LCP, GLASS-FILLED, UL94V-0,
COLOR: BLACK
PIN: 0.64MM SQ PIN, COPPER ALLOY
2. PLATING TYPE:
(1) : 0.0254 μm GOLD FLASH OVER
1.25 μm MIN. NICKEL OVERALL.
(2) : 0.025 μm MIN. GOLD PLATE ON CONTACT AND
1.88 μm MIN. TIN ON SOLDERTAIL OVER
1.25 μm MIN. NICKEL OVERALL.
(3) : 0.25 μm MIN. GOLD PLATE ON CONTACT AND
1.88 μm MIN. TIN ON SOLDERTAIL OVER
1.25 μm MIN. NICKEL OVERALL.
(4) : 0.38 μm MIN. GOLD PLATE ON CONTACT AND
1.88 μm MIN. TIN ON SOLDERTAIL OVER
1.25 μm MIN. NICKEL OVERALL.
(5) : 0.75 μm MIN. GOLD PLATE ON CONTACT AND
1.88 μm MIN. TIN ON SOLDERTAIL OVER
1.25 μm MIN. NICKEL OVERALL.
(6) : 2.50 μm MIN. TIN OVER 1.25 μm MIN. NICKEL OVERALL.
(7) : 0.38 μm MIN. GOLD PLATE ON CONTACT AND
2.50 μm MIN. TIN ON SOLDERTAIL OVER
1.25 μm MIN. NICKEL OVERALL.
(8) : 0.38 μm MIN. GOLD PLATE ON CONTACT AND
0.05 μm MIN. GOLD FLASH ON SOLDERTAIL OVER
1.25 μm MIN. NICKEL OVERALL.
(9) : 0.05 - 0.25 μm MIN. GOLD FLASH OVER
1.25 μm MIN. NICKEL OVERALL.
3. PIN PUSHOUT FORCE: 1KG MIN IN EITHER DIRECTION
4. THE ABOVE 14 CKT IS FOR ILLUSTRATION PURPOSE ONLY.
5. FOR PACKAGING OPTION PLEASE REFER TO THE TABLE.
6. RECOMMENDED PCB THICKNESS 1.60MM.
7. PRODUCT SPECIFICATION: PS-87920-019
8. WAFER TO BE FLAT WITHIN 0.003mm/mm
9. IRREGULAR CIRCUIT CUTOFF WITHIN BREAKAWAY SECTION IS PERMISSIBLE. CUTTING OR CHIPPING OF THE MAIN BODY IS NOT ACCEPTABLE.
10. PARTS ARE NOT STACKABLE ON 2.54 CENTER
11. CAP TO BE PLACED AS CENTRAL OF PART AS POSSIBLE WITH THE TOP SURFACE FLAT FOR PICK AND PLACE.
12. PACKAGING SPECIFICATION:
TRAY: PK-89990-489
BULK: PK-89990-491
TUBE: PK-87914-300 **(D16)**

ADD TUBE PK SPEC EC NO: S2017-0192 DRW:NFC500 CHKD:CGOH APPR:KHLIM	2016/09/28 2016/10/17 2016/10/18	DESCRIPTION REV	QUALITY SYMBOLS	GENERAL TOLERANCES (UNLESS SPECIFIED)		DIMENSION STYLE MM ONLY		SCALE NTS	DESIGN UNITS METRIC	THIRD ANGLE PROJECTION		
			$F_A=0$	mm	INCH	DRAWN BY KCHO	DATE 2004/11/05	2.54MM PITCH DUAL ROW HEADER SINGLE WAFER, T/H molex DOCUMENT NO. SD-87914-013 SHEET NO. 1 OF 45				
			$F_G=0$	4 PLACES ± ---	± ---	CHECKED BY PTLIM	DATE 2004/12/08					
			$F_P=0$	3 PLACES ± ---	± ---	APPROVED BY	DATE					
	2 PLACES ± 0.20	± ---	MLONG	2010/09/06								
		1 PLACE ± ---	± ---	MATERIAL NO.		SEE TABLE						
		0 PLACE ±	±	ANGULAR ± 3°								
DRAFT WHERE APPLICABLE MUST REMAIN WITHIN DIMENSIONS												

	10	9	8	7	6	5	4	3	2	1			
	PART NO. FOR TRAY PACKAGING	PART NO. FOR TUBE WITHOUT CAP PACKAGING	PART NO. FOR TUBE WITH CAP PACKAGING	PART NO. FOR TAPE & REEL WITHOUT CAP PACKAGING	PART NO. FOR TAPE & REEL WITH CAP PACKAGING	CKT SIZE	VOID POSITION	PLATING TYPE	DIMENSION				
								A	B	F	M	P	
F	87914-0211	-----	-----	-----	-----	2	----	1	2.54	----	10.92	5.84	2.79
	87914-0221	-----	-----	-----	-----	2	----	1	2.54	----	12.25	7.00	2.96
	87914-0231	-----	-----	-----	-----	2	----	1	2.54	----	13.38	6.09	5.00
	87914-0212	-----	-----	-----	-----	2	----	2	2.54	----	10.92	5.84	2.79
	87914-0222	-----	-----	-----	-----	2	----	2	2.54	----	12.25	7.00	2.96
	87914-0232	-----	-----	-----	-----	2	----	2	2.54	----	13.38	6.09	5.00
E	87914-0213	-----	-----	-----	-----	2	----	3	2.54	----	10.92	5.84	2.79
	87914-0223	-----	-----	-----	-----	2	----	3	2.54	----	12.25	7.00	2.96
	87914-0233	-----	-----	-----	-----	2	----	3	2.54	----	13.38	6.09	5.00
	87914-0214	-----	-----	-----	-----	2	----	4	2.54	----	10.92	5.84	2.79
	87914-0224	-----	-----	-----	-----	2	----	4	2.54	----	12.25	7.00	2.96
	87914-0234	-----	-----	-----	-----	2	----	4	2.54	----	13.38	6.09	5.00
D	87914-0215	-----	-----	-----	-----	2	----	5	2.54	----	10.92	5.84	2.79
	87914-0225	-----	-----	-----	-----	2	----	5	2.54	----	12.25	7.00	2.96
	87914-0235	-----	-----	-----	-----	2	----	5	2.54	----	13.38	6.09	5.00
	87914-0216	-----	-----	-----	-----	2	----	6	2.54	----	10.92	5.84	2.79
	87914-0226	-----	-----	-----	-----	2	----	6	2.54	----	12.25	7.00	2.96
	87914-0236	-----	-----	-----	-----	2	----	6	2.54	----	13.38	6.09	5.00
C													
B													

ADD TUBE PK SPEC IEC NO: S2017-0192 DRW: FCS00 CHKD: CG0H APPR: KHLIM	2016/09/28 2016/10/17 2016/10/18	DESCRIPTION REV	QUALITY SYMBOLS	GENERAL TOLERANCES (UNLESS SPECIFIED)	DIMENSION STYLE	SCALE	DESIGN UNITS	THIRD ANGLE PROJECTION																																				
					MM ONLY	NTS	METRIC																																					
			$\nabla = 0$ $\nabla = 0$ $\nabla = 0$	<table border="1"> <tr><th colspan="2">mm</th><th>INCH</th></tr> <tr><td>4 PLACES</td><td>± ---</td><td>± ---</td></tr> <tr><td>3 PLACES</td><td>± ---</td><td>± ---</td></tr> <tr><td>2 PLACES</td><td>± 0.20</td><td>± ---</td></tr> <tr><td>1 PLACE</td><td>± ---</td><td>± ---</td></tr> <tr><td>0 PLACE</td><td>±</td><td>±</td></tr> </table>	mm		INCH	4 PLACES	± ---	± ---	3 PLACES	± ---	± ---	2 PLACES	± 0.20	± ---	1 PLACE	± ---	± ---	0 PLACE	±	±	<table border="1"> <tr><th colspan="2">DRAWN BY</th><th>DATE</th></tr> <tr><td>KCHO</td><td></td><td>2004/11/05</td></tr> <tr><th colspan="2">CHECKED BY</th><th>DATE</th></tr> <tr><td>PTLIM</td><td></td><td>2004/12/08</td></tr> <tr><th colspan="2">APPROVED BY</th><th>DATE</th></tr> <tr><td>MLONG</td><td></td><td>2010/09/06</td></tr> </table>	DRAWN BY		DATE	KCHO		2004/11/05	CHECKED BY		DATE	PTLIM		2004/12/08	APPROVED BY		DATE	MLONG		2010/09/06	TITLE 2.54MM PITCH DUAL ROW HEADER SINGLE WAFER, T/H		
mm		INCH																																										
4 PLACES	± ---	± ---																																										
3 PLACES	± ---	± ---																																										
2 PLACES	± 0.20	± ---																																										
1 PLACE	± ---	± ---																																										
0 PLACE	±	±																																										
DRAWN BY		DATE																																										
KCHO		2004/11/05																																										
CHECKED BY		DATE																																										
PTLIM		2004/12/08																																										
APPROVED BY		DATE																																										
MLONG		2010/09/06																																										
			ANGULAR ± 3 °	DRAFT WHERE APPLICABLE MUST REMAIN WITHIN DIMENSIONS	SEE TABLE	molex DOCUMENT NO. SD-87914-013		SHEET NO. 2 OF 45																																				
					THIS DRAWING CONTAINS INFORMATION THAT IS PROPRIETARY TO MOLEX INCORPORATED AND SHOULD NOT BE USED WITHOUT WRITTEN PERMISSION																																							

	10	9	8	7	6	5	4	3	2	1				
	PART NO FOR TRAY PACKAGING	PART NO. FOR TUBE WITHOUT CAP PACKAGING	PART NO. FOR TUBE WITH CAP PACKAGING	PART NO. FOR TAPE & REEL WITHOUT CAP PACKAGING	PART NO. FOR TAPE & REEL WITH CAP PACKAGING	CKT SIZE	VOID POSITION	PLATING TYPE	DIMENSION					
								A	B	F	M	P	G	
F	87914-0611	-----	-----	-----	-----	6	----	1	7.62	5.08	10.92	5.84	2.79	----
	87914-0621	-----	-----	-----	-----	6	----	1	7.62	5.08	12.25	7.00	2.96	----
	87914-0631	-----	-----	-----	-----	6	----	1	7.62	5.08	13.38	6.09	5.00	----
	87914-0612	-----	-----	-----	-----	6	----	2	7.62	5.08	10.92	5.84	2.79	----
	87914-0622	-----	-----	-----	-----	6	----	2	7.62	5.08	12.25	7.00	2.96	----
	87914-0632	-----	-----	-----	-----	6	----	2	7.62	5.08	13.38	6.09	5.00	----
E	87914-0613	-----	-----	-----	-----	6	----	3	7.62	5.08	10.92	5.84	2.79	----
	87914-0623	-----	-----	-----	-----	6	----	3	7.62	5.08	12.25	7.00	2.96	----
	87914-0633	-----	-----	-----	-----	6	----	3	7.62	5.08	13.38	6.09	5.00	----
	87914-0614	-----	-----	-----	-----	6	----	4	7.62	5.08	10.92	5.84	2.79	----
	87914-0624	-----	-----	-----	-----	6	----	4	7.62	5.08	12.25	7.00	2.96	----
	87914-0634	-----	-----	-----	-----	6	----	4	7.62	5.08	13.38	6.09	5.00	----
D	87914-0615	-----	-----	-----	-----	6	----	5	7.62	5.08	10.92	5.84	2.79	----
	87914-0625	-----	-----	-----	-----	6	----	5	7.62	5.08	12.25	7.00	2.96	----
	87914-0635	-----	-----	-----	-----	6	----	5	7.62	5.08	13.38	6.09	5.00	----
	87914-0616	-----	-----	-----	-----	6	----	6	7.62	5.08	10.92	5.84	2.79	----
	87914-0626	-----	-----	-----	-----	6	----	6	7.62	5.08	12.25	7.00	2.96	----
	87914-0636	-----	-----	-----	-----	6	----	6	7.62	5.08	13.38	6.09	5.00	----
C														

ADD TUBE PK SPEC EC NO: S2017-0192 DRWN:FCS00 2016/09/28 CHKD:CG0H 2016/10/17 APPR:KHLIM 2016/10/18	DESCRIPTION REV	QUALITY SYMBOLS	GENERAL TOLERANCES (UNLESS SPECIFIED)	DIMENSION STYLE	SCALE	DESIGN UNITS	THIRD ANGLE PROJECTION		
		$\nabla=0$ $\nabla=0$ $\nabla=0$	mm INCH 4 PLACES ± --- ± --- 3 PLACES ± --- ± --- 2 PLACES ± 0.20 ± --- 1 PLACE ± --- ± --- 0 PLACE ± ±	MM ONLY	NTS	METRIC	DRAWN BY: KCHO DATE: 2004/11/05 CHECKED BY: DATE: PTL IM DATE: 2004/12/08 APPROVED BY: DATE: MLONG DATE: 2010/09/06	TITLE	2.54MM PITCH DUAL ROW HEADER SINGLE WAFER, T/H
			ANGULAR ± 3 °	SEE TABLE			molex DOCUMENT NO. SD-87914-013	SHEET NO. 4 OF 45	
		D16	DRAFT WHERE APPLICABLE MUST REMAIN WITHIN DIMENSIONS	THIS DRAWING CONTAINS INFORMATION THAT IS PROPRIETARY TO MOLEX INCORPORATED AND SHOULD NOT BE USED WITHOUT WRITTEN PERMISSION					

	10	9	8	7	6	5	4	3	2	1					
	PART NO FOR TRAY PACKAGING	PART NO. FOR TUBE WITHOUT CAP PACKAGING	PART NO. FOR TUBE WITH CAP PACKAGING	PART NO. FOR TAPE & REEL WITHOUT CAP PACKAGING	PART NO. FOR TAPE & REEL WITH CAP PACKAGING	CKT SIZE	VOID POSITION	PLATING TYPE	DIMENSION						
								A	B	F	M	P	G		
F	87914-0811	-----	-----	-----	-----	8	-----	1	10.16	7.62	10.92	5.84	2.79	----	F
	87914-0821	-----	-----	-----	-----	8	-----	1	10.16	7.62	12.25	7.00	2.96	----	
	87914-0831	-----	-----	-----	-----	8	-----	1	10.16	7.62	13.38	6.09	5.00	----	
	87914-0812	-----	-----	-----	-----	8	-----	2	10.16	7.62	10.92	5.84	2.79	----	
	87914-0822	-----	-----	-----	-----	8	-----	2	10.16	7.62	12.25	7.00	2.96	----	
	87914-0832	-----	-----	-----	-----	8	-----	2	10.16	7.62	13.38	6.09	5.00	----	
E	87914-0813	-----	-----	-----	-----	8	-----	3	10.16	7.62	10.92	5.84	2.79	----	E
	87914-0823	-----	-----	-----	-----	8	-----	3	10.16	7.62	12.25	7.00	2.96	----	
	87914-0833	-----	-----	-----	-----	8	-----	4	10.16	7.62	13.38	6.09	5.00	----	
	87914-0814	-----	-----	-----	-----	8	-----	4	10.16	7.62	10.92	5.84	2.79	----	
	87914-0824	-----	-----	-----	-----	8	-----	4	10.16	7.62	12.25	7.00	2.96	----	
	87914-0834	-----	-----	-----	-----	8	-----	4	10.16	7.62	13.38	6.09	5.00	----	
D	87914-0815	-----	-----	-----	-----	8	-----	5	10.16	7.62	10.92	5.84	2.79	----	D
	87914-0825	-----	-----	-----	-----	8	-----	5	10.16	7.62	12.25	7.00	2.96	----	
	87914-0835	-----	-----	-----	-----	8	-----	5	10.16	7.62	13.38	6.09	5.00	----	
	87914-0816	-----	-----	-----	-----	8	-----	6	10.16	7.62	10.92	5.84	2.79	----	
	87914-0826	-----	-----	-----	-----	8	-----	6	10.16	7.62	12.25	7.00	2.96	----	
	87914-0836	-----	-----	-----	-----	8	-----	6	10.16	7.62	13.38	6.09	5.00	----	
C	87914-0807	-----	-----	-----	-----	8	2.3,4,5,6,8	6	10.16	7.62	21.75	16.51	2.95	----	C

B															B
---	--	--	--	--	--	--	--	--	--	--	--	--	--	--	---

ADD TUBE PK SPEC IEC NO: S2017-0192 DRWN:FC500 2016/09/28 CH'KD:CG0H 2016/10/17 APPR:KHLIM 2016/10/18	QUALITY SYMBOLS $\nabla = 0$ $\nabla = 0$ $\nabla = 0$	GENERAL TOLERANCES (UNLESS SPECIFIED)		DIMENSION STYLE MM ONLY		SCALE NTS	DESIGN UNITS METRIC	THIRD ANGLE PROJECTION	
		4 PLACES \pm --- \pm --- 3 PLACES \pm --- \pm --- 2 PLACES \pm 0.20 \pm --- 1 PLACE \pm --- \pm --- 0 PLACE \pm --- \pm ---	mm INCH	DRAWN BY KCHO	DATE 2004/11/05	TITLE 2.54MM PITCH DUAL ROW HEADER SINGLE WAFER, T/H			
		ANGULAR \pm 3 °		CHECKED BY PTLIM	DATE 2004/12/08				
		DRAFT WHERE APPLICABLE MUST REMAIN WITHIN DIMENSIONS		APPROVED BY MLONG	DATE 2010/09/06				

PART NO FOR TRAY PACKAGING	PART NO. FOR TUBE WITHOUT CAP PACKAGING	PART NO. FOR TUBE WITH CAP PACKAGING	PART NO. FOR TAPE & REEL WITHOUT CAP PACKAGING	PART NO. FOR TAPE & REEL WITH CAP PACKAGING	PART NO. FOR BULK PACKAGING	CKT SIZE	VOID POSITION	PLATING TYPE	DIMENSION					
									A	B	F	M	P	G
87914-1011	-----	-----	-----	-----	-----	10	----	1	12.70	10.16	10.92	5.84	2.79	----
87914-1021	-----	-----	-----	-----	-----	10	----	1	12.70	10.16	12.25	7.00	2.96	----
87914-1031	-----	-----	-----	-----	-----	10	----	1	12.70	10.16	13.38	6.09	5.00	----
87914-1012	-----	-----	-----	-----	-----	10	----	2	12.70	10.16	10.92	5.84	2.79	----
87914-1022	-----	-----	-----	-----	-----	10	----	2	12.70	10.16	12.25	7.00	2.96	----
87914-1032	-----	-----	-----	-----	-----	10	----	2	12.70	10.16	13.38	6.09	5.00	----
87914-1013	-----	-----	-----	-----	-----	10	----	3	12.70	10.16	10.92	5.84	2.79	----
87914-1023	-----	-----	-----	-----	-----	10	----	3	12.70	10.16	12.25	7.00	2.96	----
87914-1033	-----	-----	-----	-----	-----	10	----	3	12.70	10.16	13.38	6.09	5.00	----
87914-1014	-----	-----	-----	-----	-----	10	----	4	12.70	10.16	10.92	5.84	2.79	----
87914-1024	-----	-----	-----	-----	-----	10	----	4	12.70	10.16	12.25	7.00	2.96	----
87914-1034	-----	-----	-----	-----	-----	10	----	4	12.70	10.16	13.38	6.09	5.00	----
87914-1015	-----	-----	-----	-----	-----	10	----	5	12.70	10.16	10.92	5.84	2.79	----
87914-1025	-----	-----	-----	-----	-----	10	----	5	12.70	10.16	12.25	7.00	2.96	----
87914-1035	-----	-----	-----	-----	-----	10	----	5	12.70	10.16	13.38	6.09	5.00	----
87914-1016	-----	-----	-----	-----	-----	10	----	6	12.70	10.16	10.92	5.84	2.79	----
87914-1026	-----	-----	-----	-----	-----	10	----	6	12.70	10.16	12.25	7.00	2.96	----
87914-1036	-----	-----	-----	-----	-----	10	----	6	12.70	10.16	13.38	6.09	5.00	----
87914-0001	-----	-----	-----	-----	-----	10	----	7	12.70	10.16	12.07	5.97	3.81	----
-----	-----	-----	-----	-----	87914-1037	10	9	4	12.70	10.16	10.92	5.84	2.79	----

ADD TUBE PK SPEC EC NO: S2017-0192 DRWN:FCS00 2016/09/28 CHKD:G0H 2016/10/17 APPR:KHLIM 2016/10/18	QUALITY SYMBOLS 	GENERAL TOLERANCES (UNLESS SPECIFIED)		DIMENSION STYLE MM ONLY		SCALE NTS	DESIGN UNITS METRIC	THIRD ANGLE PROJECTION	
				mm	INCH	DRAWN BY KCHO	DATE 2004/11/05		TITLE
				4 PLACES ± --- ± ---	3 PLACES ± --- ± ---	CHECKED BY PTLIM	DATE 2004/12/08	2.54MM PITCH DUAL ROW HEADER SINGLE WAFER, T/H 	
				2 PLACES ± 0.20 ± ---	1 PLACE ± --- ± ---	APPROVED BY MLONG	DATE 2010/09/06		
		0 PLACE ± ±	ANGULAR ± 3 °		MATERIAL NO.	DOCUMENT NO.	SHEET NO.		
		DRAFT WHERE APPLICABLE MUST REMAIN WITHIN DIMENSIONS		SEE TABLE		SD-87914-013		8 OF 45	
				THIS DRAWING CONTAINS INFORMATION THAT IS PROPRIETARY TO MOLEX INCORPORATED AND SHOULD NOT BE USED WITHOUT WRITTEN PERMISSION					

10 9 8 7 6 5 4 3 2 1

	PART NO. FOR TRAY PACKAGING	PART NO. FOR TUBE WITHOUT CAP PACKAGING	PART NO. FOR TUBE WITH CAP PACKAGING	PART NO. FOR TAPE & REEL WITHOUT CAP PACKAGING	PART NO. FOR TAPE & REEL WITH CAP PACKAGING	CKT SIZE	VOID POSITION	PLATING TYPE	DIMENSION				
									A	B	F	M	P
F	87914-1211	-----	-----	-----	-----	12	----	1	15.24	12.70	10.92	5.84	2.79
	-----	87914-1291	-----	-----	-----	12	----	9	15.24	12.70	10.92	5.84	2.79
	87914-1221	-----	-----	-----	-----	12	----	1	15.24	12.70	12.25	7.00	2.96
	87914-1231	-----	-----	-----	-----	12	----	1	15.24	12.70	13.38	6.09	5.00
	87914-1212	-----	-----	-----	-----	12	----	2	15.24	12.70	10.92	5.84	2.79
	87914-1222	-----	-----	-----	-----	12	----	2	15.24	12.70	12.25	7.00	2.96
E	87914-1232	-----	-----	-----	-----	12	----	2	15.24	12.70	13.38	6.09	5.00
	87914-1213	-----	-----	-----	-----	12	----	3	15.24	12.70	10.92	5.84	2.79
	87914-1223	-----	-----	-----	-----	12	----	3	15.24	12.70	12.25	7.00	2.96
	87914-1233	-----	-----	-----	-----	12	----	3	15.24	12.70	13.38	6.09	5.00
	87914-1214	-----	-----	-----	-----	12	----	4	15.24	12.70	10.92	5.84	2.79
	87914-1224	-----	-----	-----	-----	12	----	4	15.24	12.70	12.25	7.00	2.96
D	87914-1234	-----	-----	-----	-----	12	----	4	15.24	12.70	13.38	6.09	5.00
	87914-1215	-----	-----	-----	-----	12	----	5	15.24	12.70	10.92	5.84	2.79
	87914-1225	-----	-----	-----	-----	12	----	5	15.24	12.70	12.25	7.00	2.96
	87914-1235	-----	-----	-----	-----	12	----	5	15.24	12.70	13.38	6.09	5.00
	87914-1216	-----	-----	-----	-----	12	----	6	15.24	12.70	10.92	5.84	2.79
	87914-1226	-----	-----	-----	-----	12	----	6	15.24	12.70	12.25	7.00	2.96
C	87914-1236	-----	-----	-----	-----	12	----	6	15.24	12.70	13.38	6.09	5.00

B

ADD TUBE PK SPEC EC NO: S2017-0192 DRWN: FCS00 2016/09/28 CH'KD: CG0H 2016/10/17 APPR: KHL IM 2016/10/18	DESCRIPTION D16	QUALITY SYMBOLS	GENERAL TOLERANCES (UNLESS SPECIFIED)	DIMENSION STYLE	SCALE	DESIGN UNITS	THIRD ANGLE PROJECTION		
		$\nabla = 0$ $\nabla = 0$ $\nabla = 0$	mm INCH 4 PLACES ± --- ± --- 3 PLACES ± --- ± --- 2 PLACES ± 0.20 ± --- 1 PLACE ± --- ± --- 0 PLACE ± ±	MM ONLY	NTS	METRIC	DRAWN BY: KCHO DATE: 2004/11/05 CHECKED BY: DATE: PTL IM DATE: 2004/12/08 APPROVED BY: DATE: MLONG DATE: 2010/09/06	TITLE	2.54MM PITCH DUAL ROW HEADER SINGLE WAFER, T/H
		ANGULAR ± 3°	DRAFT WHERE APPLICABLE MUST REMAIN WITHIN DIMENSIONS	SEE TABLE	DOCUMENT NO.	SD-87914-013	SHEET NO.	9 OF 45	
		THIS DRAWING CONTAINS INFORMATION THAT IS PROPRIETARY TO MOLEX INCORPORATED AND SHOULD NOT BE USED WITHOUT WRITTEN PERMISSION							

fb_frame_A3_P_AM_T Rev. G 2012/01/11 9 8 7 6 5 4 3 2 1

	10	9	8	7	6	5	4	3	2	1				
	PART NO FOR TRAY PACKAGING	PART NO. FOR TUBE WITHOUT CAP PACKAGING	PART NO. FOR TUBE WITH CAP PACKAGING	PART NO. FOR TAPE & REEL WITHOUT CAP PACKAGING	PART NO. FOR TAPE & REEL WITH CAP PACKAGING	CKT SIZE	VOID POSITION	PLATING TYPE	DIMENSION					
								A	B	F	M	P		
F	87914-1611	-----	-----	-----	-----	16	----	1	20.32	17.78	10.92	5.84	2.79	F
	87914-1621	-----	-----	-----	-----	16	----	1	20.32	17.78	12.25	7.00	2.96	
	87914-1631	-----	-----	-----	-----	16	----	1	20.32	17.78	13.38	6.09	5.00	
	87914-1612	-----	-----	-----	-----	16	----	2	20.32	17.78	10.92	5.84	2.79	
	87914-1622	-----	-----	-----	-----	16	----	2	20.32	17.78	12.25	7.00	2.96	
	87914-1632	-----	-----	-----	-----	16	----	2	20.32	17.78	13.38	6.09	5.00	
E	87914-1613	-----	-----	-----	-----	16	----	3	20.32	17.78	10.92	5.84	2.79	E
	87914-1623	-----	-----	-----	-----	16	----	3	20.32	17.78	12.25	7.00	2.96	
	87914-1633	-----	-----	-----	-----	16	----	3	20.32	17.78	13.38	6.09	5.00	
	87914-1614	-----	-----	-----	-----	16	----	4	20.32	17.78	10.92	5.84	2.79	
	87914-1624	-----	-----	-----	-----	16	----	4	20.32	17.78	12.25	7.00	2.96	
	87914-1634	-----	-----	-----	-----	16	----	4	20.32	17.78	13.38	6.09	5.00	
D	87914-1615	-----	-----	-----	-----	16	----	5	20.32	17.78	10.92	5.84	2.79	D
	87914-1625	-----	-----	-----	-----	16	----	5	20.32	17.78	12.25	7.00	2.96	
	87914-1635	-----	-----	-----	-----	16	----	5	20.32	17.78	13.38	6.09	5.00	
	87914-1616	-----	-----	-----	-----	16	----	6	20.32	17.78	10.92	5.84	2.79	
	87914-1626	-----	-----	-----	-----	16	----	6	20.32	17.78	12.25	7.00	2.96	
	87914-1636	-----	-----	-----	-----	16	----	6	20.32	17.78	13.38	6.09	5.00	
C	87914-1600	-----	-----	-----	-----	16	----	6	20.32	17.78	9.49	4.50	2.70	C
	87914-1637	-----	-----	-----	-----	16	----	6	20.32	17.78	15.79	10.45	3.05	
B														B

ADD TUBE PK SPEC IEC NO: S2017-0192 DRW: FCS00 CHKD: CG0H APPR: KHLIM	2016/09/28 2016/10/17 2016/10/18	DESCRIPTION REV	QUALITY SYMBOLS	GENERAL TOLERANCES (UNLESS SPECIFIED)	DIMENSION STYLE	SCALE	DESIGN UNITS	THIRD ANGLE PROJECTION			
			$\nabla = 0$ $\nabla = 0$ $\nabla = 0$	mm INCH 4 PLACES ± --- ± --- 3 PLACES ± --- ± --- 2 PLACES ± 0.20 ± --- 1 PLACE ± --- ± --- 0 PLACE ± ±	MM ONLY	NTS	METRIC	DRAWN BY: KCHO DATE: 2004/11/05 CHECKED BY: PTLIM DATE: 2004/12/08 APPROVED BY: MLONG DATE: 2010/09/06	TITLE: 2.54MM PITCH DUAL ROW HEADER SINGLE WAFER, T/H 		
				ANGULAR ± 3 °	SEE TABLE	MATERIAL NO.	DOCUMENT NO.	SHEET NO.			
			D16	DRAFT WHERE APPLICABLE MUST REMAIN WITHIN DIMENSIONS	THIS DRAWING CONTAINS INFORMATION THAT IS PROPRIETARY TO MOLEX INCORPORATED AND SHOULD NOT BE USED WITHOUT WRITTEN PERMISSION		SD-87914-013	13 OF 45			

PART NO FOR TRAY PACKAGING	PART NO. FOR TUBE WITHOUT CAP PACKAGING	PART NO. FOR TUBE WITH CAP PACKAGING	PART NO. FOR TAPE & REEL WITHOUT CAP PACKAGING	PART NO. FOR TAPE & REEL WITH CAP PACKAGING	CKT SIZE	VOID POSITION	PLATING TYPE	DIMENSION					
								A	B	F	M	P	G
87914-1811	-----	-----	-----	-----	18	----	1	22.86	20.32	10.92	5.84	2.79	----
87914-1821	-----	-----	-----	-----	18	----	1	22.86	20.32	12.25	7.00	2.96	----
87914-1831	-----	-----	-----	-----	18	----	1	22.86	20.32	13.38	6.09	5.00	----
87914-1812	-----	-----	-----	-----	18	----	2	22.86	20.32	10.92	5.84	2.79	----
87914-1822	-----	-----	-----	-----	18	----	2	22.86	20.32	12.25	7.00	2.96	----
87914-1832	-----	-----	-----	-----	18	----	2	22.86	20.32	13.38	6.09	5.00	----
87914-1813	-----	-----	-----	-----	18	----	3	22.86	20.32	10.92	5.84	2.79	----
87914-1823	-----	-----	-----	-----	18	----	3	22.86	20.32	12.25	7.00	2.96	----
87914-1833	-----	-----	-----	-----	18	----	3	22.86	20.32	13.38	6.09	5.00	----
87914-1814	-----	-----	-----	-----	18	----	4	22.86	20.32	10.92	5.84	2.79	----
87914-1824	-----	-----	-----	-----	18	----	4	22.86	20.32	12.25	7.00	2.96	----
87914-1834	-----	-----	-----	-----	18	----	4	22.86	20.32	13.38	6.09	5.00	----
87914-1815	-----	-----	-----	-----	18	----	5	22.86	20.32	10.92	5.84	2.79	----
87914-1825	-----	-----	-----	-----	18	----	5	22.86	20.32	12.25	7.00	2.96	----
87914-1835	-----	-----	-----	-----	18	----	5	22.86	20.32	13.38	6.09	5.00	----
87914-1816	-----	-----	-----	-----	18	----	6	22.86	20.32	10.92	5.84	2.79	----
87914-1826	-----	-----	-----	-----	18	----	6	22.86	20.32	12.25	7.00	2.96	----
87914-1836	-----	-----	-----	-----	18	----	6	22.86	20.32	13.38	6.09	5.00	----
-----	-----	87914-1807	-----	-----	18	----	6	22.86	20.32	17.02	11.05	3.68	18.02

ADD TUBE PK SPEC IEC NO: S2017-0192 DRW: FCS00 CHKD: CGOH APPR: KHLIM	2016/09/28 2016/10/17 2016/10/18	QUALITY SYMBOLS $\nabla = 0$ $\nabla = 0$ $\nabla = 0$	GENERAL TOLERANCES (UNLESS SPECIFIED)		DIMENSION STYLE MM ONLY		SCALE NTS	DESIGN UNITS METRIC	THIRD ANGLE PROJECTION					
					mm	INCH	DRAWN BY KCHO	DATE 2004/11/05	TITLE 2.54MM PITCH DUAL ROW HEADER SINGLE WAFER, T/H					
			4 PLACES	± ---	± ---	3 PLACES	± ---	± ---	CHECKED BY PTLIM	DATE 2004/12/08				
			2 PLACES	± 0.20	± ---	1 PLACE	± ---	± ---	APPROVED BY MLONG	DATE 2010/09/06				
0 PLACE	±	±	ANGULAR ± 3 °		MATERIAL NO.		DOCUMENT NO.		SHEET NO.					
DRAFT WHERE APPLICABLE MUST REMAIN WITHIN DIMENSIONS			SEE TABLE		SD-87914-013		14 OF 45		THIS DRAWING CONTAINS INFORMATION THAT IS PROPRIETARY TO MOLEX INCORPORATED AND SHOULD NOT BE USED WITHOUT WRITTEN PERMISSION					

PART NO FOR TRAY PACKAGING	PART NO. FOR TUBE WITHOUT CAP PACKAGING	PART NO. FOR TUBE WITH CAP PACKAGING	PART NO. FOR TAPE & REEL WITHOUT CAP PACKAGING	PART NO. FOR TAPE & REEL WITH CAP PACKAGING	CKT SIZE	VOID POSITION	PLATING TYPE	DIMENSION				
								A	B	F	M	P
								F	87914-2211	-----	-----	-----
	87914-2221	-----	-----	-----	22	----	1	27.94	25.40	12.25	7.00	2.96
	87914-2231	-----	-----	-----	22	----	1	27.94	25.40	13.38	6.09	5.00
	87914-2212	-----	-----	-----	22	----	2	27.94	25.40	10.92	5.84	2.79
	87914-2222	-----	-----	-----	22	----	2	27.94	25.40	12.25	7.00	2.96
	87914-2232	-----	-----	-----	22	----	2	27.94	25.40	13.38	6.09	5.00
E	87914-2213	-----	-----	-----	22	----	3	27.94	25.40	10.92	5.84	2.79
	87914-2223	-----	-----	-----	22	----	3	27.94	25.40	12.25	7.00	2.96
	87914-2233	-----	-----	-----	22	----	3	27.94	25.40	13.38	6.09	5.00
	87914-2214	-----	-----	-----	22	----	4	27.94	25.40	10.92	5.84	2.79
	87914-2224	-----	-----	-----	22	----	4	27.94	25.40	12.25	7.00	2.96
	87914-2234	-----	-----	-----	22	----	4	27.94	25.40	13.38	6.09	5.00
D	87914-2215	-----	-----	-----	22	----	5	27.94	25.40	10.92	5.84	2.79
	87914-2225	-----	-----	-----	22	----	5	27.94	25.40	12.25	7.00	2.96
	87914-2235	-----	-----	-----	22	----	5	27.94	25.40	13.38	6.09	5.00
	87914-2216	-----	-----	-----	22	----	6	27.94	25.40	10.92	5.84	2.79
	87914-2226	-----	-----	-----	22	----	6	27.94	25.40	12.25	7.00	2.96
	87914-2236	-----	-----	-----	22	----	6	27.94	25.40	13.38	6.09	5.00
C												
B												

ADD TUBE PK SPEC IEC NO: S2017-0192 DRW: FCS00 CHKD: CG0H APPR: KHL IM	2016/09/28 2016/10/17 2016/10/18	QUALITY SYMBOLS 	GENERAL TOLERANCES (UNLESS SPECIFIED)		DIMENSION STYLE MM ONLY		SCALE NTS	DESIGN UNITS METRIC	THIRD ANGLE PROJECTION			
										TITLE 2.54MM PITCH DUAL ROW HEADER SINGLE WAFER, T/H		
			4 PLACES	± ---	± ---	DRAWN BY	DATE					
			3 PLACES	± ---	± ---	3 PLACES	± ---	± ---	PTL IM	2004/11/05		
2 PLACES	± 0.20	± ---	2 PLACES	± 0.20	± ---	APPROVED BY	DATE					
1 PLACE	± ---	± ---	1 PLACE	± ---	± ---	MLONG	2010/09/06					
0 PLACE	±	±	0 PLACE	±	±	MATERIAL NO.		DOCUMENT NO.		SHEET NO.		
ANGULAR ± 3 °		DRAFT WHERE APPLICABLE MUST REMAIN WITHIN DIMENSIONS		SEE TABLE		SD-87914-013		16 OF 45				
THIS DRAWING CONTAINS INFORMATION THAT IS PROPRIETARY TO MOLEX INCORPORATED AND SHOULD NOT BE USED WITHOUT WRITTEN PERMISSION												

PART NO FOR TRAY PACKAGING	PART NO. FOR TUBE WITHOUT CAP PACKAGING	PART NO. FOR TUBE WITH CAP PACKAGING	PART NO. FOR TAPE & REEL WITHOUT CAP PACKAGING	PART NO. FOR TAPE & REEL WITH CAP PACKAGING	CKT SIZE	VOID POSITION	PLATING TYPE	DIMENSION				
								A	B	F	M	P
								F	87914-2411	-----	-----	-----
	87914-2421	-----	-----	-----	24	----	1	30.48	27.94	12.25	7.00	2.96
	87914-2431	-----	-----	-----	24	----	1	30.48	27.94	13.38	6.09	5.00
	87914-2412	-----	-----	-----	24	----	2	30.48	27.94	10.92	5.84	2.79
	87914-2422	-----	-----	-----	24	----	2	30.48	27.94	12.25	7.00	2.96
	87914-2432	-----	-----	-----	24	----	2	30.48	27.94	13.38	6.09	5.00
E	87914-2413	-----	-----	-----	24	----	3	30.48	27.94	10.92	5.84	2.79
	87914-2423	-----	-----	-----	24	----	3	30.48	27.94	12.25	7.00	2.96
	87914-2433	-----	-----	-----	24	----	3	30.48	27.94	13.38	6.09	5.00
	87914-2414	-----	-----	-----	24	----	4	30.48	27.94	10.92	5.84	2.79
	87914-2424	-----	-----	-----	24	----	4	30.48	27.94	12.25	7.00	2.96
	87914-2434	-----	-----	-----	24	----	4	30.48	27.94	13.38	6.09	5.00
D	87914-2415	-----	-----	-----	24	----	5	30.48	27.94	10.92	5.84	2.79
	87914-2425	-----	-----	-----	24	----	5	30.48	27.94	12.25	7.00	2.96
	87914-2435	-----	-----	-----	24	----	5	30.48	27.94	13.38	6.09	5.00
	87914-2416	-----	-----	-----	24	----	6	30.48	27.94	10.92	5.84	2.79
	87914-2426	-----	-----	-----	24	----	6	30.48	27.94	12.25	7.00	2.96
	87914-2436	-----	-----	-----	24	----	6	30.48	27.94	13.38	6.09	5.00
C												
B												

ADD TUBE PK SPEC IEC NO: S2017-0192 DRWN:FC500 CHKD:CG0H APPR:KHLIM	2016/09/28 2016/10/17 2016/10/18	QUALITY SYMBOLS 	GENERAL TOLERANCES (UNLESS SPECIFIED)		DIMENSION STYLE MM ONLY		SCALE NTS	DESIGN UNITS METRIC	THIRD ANGLE PROJECTION		
					mm	INCH	DRAWN BY KCHO	DATE 2004/11/05		TITLE 2.54MM PITCH DUAL ROW HEADER SINGLE WAFER, T/H	
			4 PLACES	± ---	± ---	3 PLACES	± ---	± ---	CHECKED BY PTLIM	DATE 2004/12/08	molex
			2 PLACES	± 0.20	± ---	1 PLACE	± ---	± ---	APPROVED BY MLONG	DATE 2010/09/06	
0 PLACE	±	±	ANGULAR ± 3 °		MATERIAL NO.	DOCUMENT NO.	SHEET NO.				
DRAFT WHERE APPLICABLE MUST REMAIN WITHIN DIMENSIONS		SEE TABLE		THIS DRAWING CONTAINS INFORMATION THAT IS PROPRIETARY TO MOLEX INCORPORATED AND SHOULD NOT BE USED WITHOUT WRITTEN PERMISSION		SD-87914-013		17 OF 45			

F	10													9													8													7													6													5													4													3													2													1												
	PART NO FOR TRAY PACKAGING	PART NO. FOR TUBE WITHOUT CAP PACKAGING	PART NO. FOR TUBE WITH CAP PACKAGING	PART NO. FOR TAPE & REEL WITHOUT CAP PACKAGING	PART NO. FOR TAPE & REEL WITH CAP PACKAGING	CKT SIZE	VOID POSITION	PLATING TYPE	DIMENSION																																																																																																																									
									A	B	F	M	P																																																																																																																					
	87914-2611	-----	-----	-----	-----	26	----	1	33.02	30.48	10.92	5.84	2.79																																																																																																																					
	87914-2621	-----	-----	-----	-----	26	----	1	33.02	30.48	12.25	7.00	2.96																																																																																																																					
	87914-2631	-----	-----	-----	-----	26	----	1	33.02	30.48	13.38	6.09	5.00																																																																																																																					
	87914-2612	-----	-----	-----	-----	26	----	2	33.02	30.48	10.92	5.84	2.79																																																																																																																					
	87914-2622	-----	-----	-----	-----	26	----	2	33.02	30.48	12.25	7.00	2.96																																																																																																																					
	87914-2632	-----	-----	-----	-----	26	----	2	33.02	30.48	13.38	6.09	5.00																																																																																																																					
E	87914-2613	-----	-----	-----	-----	26	----	3	33.02	30.48	10.92	5.84	2.79																																																																																																																					
	87914-2623	-----	-----	-----	-----	26	----	3	33.02	30.48	12.25	7.00	2.96																																																																																																																					
	87914-2633	-----	-----	-----	-----	26	----	3	33.02	30.48	13.38	6.09	5.00																																																																																																																					
	87914-2614	-----	-----	-----	-----	26	----	4	33.02	30.48	10.92	5.84	2.79																																																																																																																					
	87914-2624	-----	-----	-----	-----	26	----	4	33.02	30.48	12.25	7.00	2.96																																																																																																																					
	87914-2634	-----	-----	-----	-----	26	----	4	33.02	30.48	13.38	6.09	5.00																																																																																																																					
D	87914-2615	-----	-----	-----	-----	26	----	5	33.02	30.48	10.92	5.84	2.79																																																																																																																					
	87914-2625	-----	-----	-----	-----	26	----	5	33.02	30.48	12.25	7.00	2.96																																																																																																																					
	87914-2635	-----	-----	-----	-----	26	----	5	33.02	30.48	13.38	6.09	5.00																																																																																																																					
	87914-2616	-----	-----	-----	-----	26	----	6	33.02	30.48	10.92	5.84	2.79																																																																																																																					
	87914-2626	-----	-----	-----	-----	26	----	6	33.02	30.48	12.25	7.00	2.96																																																																																																																					
	87914-2636	-----	-----	-----	-----	26	----	6	33.02	30.48	13.38	6.09	5.00																																																																																																																					
C																																																																																																																																		
B																																																																																																																																		

ADD TUBE PK SPEC IEC NO: S2017-0192 DRWN:FC300 2016/09/28 CHKD:CG0H 2016/10/17 APPR:KHLIM 2016/10/18	QUALITY SYMBOLS 	GENERAL TOLERANCES (UNLESS SPECIFIED)		DIMENSION STYLE		SCALE	DESIGN UNITS	THIRD ANGLE PROJECTION	
				MM ONLY		NTS	METRIC		
				DRAWN BY DATE		TITLE			
				CHECKED BY DATE		2.54MM PITCH DUAL ROW HEADER SINGLE WAFER, T/H			
		APPROVED BY DATE							
		MATERIAL NO.						DOCUMENT NO.	
		ANGULAR ± 3 °		SEE TABLE		SD-87914-013		SHEET NO.	
		DRAFT WHERE APPLICABLE MUST REMAIN WITHIN DIMENSIONS		THIS DRAWING CONTAINS INFORMATION THAT IS PROPRIETARY TO MOLEX INCORPORATED AND SHOULD NOT BE USED WITHOUT WRITTEN PERMISSION				18 OF 45	

PART NO FOR TRAY PACKAGING	PART NO. FOR TUBE WITHOUT CAP PACKAGING	PART NO. FOR TUBE WITH CAP PACKAGING	PART NO. FOR TAPE & REEL WITHOUT CAP PACKAGING	PART NO. FOR TAPE & REEL WITH CAP PACKAGING	CKT SIZE	VOID POSITION	PLATING TYPE	DIMENSION				
								A	B	F	M	P
F	87914-2811	-----	-----	-----	28	----	1	35.56	33.02	10.92	5.84	2.79
	87914-2821	-----	-----	-----	28	----	1	35.56	33.02	12.25	7.00	2.96
	87914-2831	-----	-----	-----	28	----	1	35.56	33.02	13.38	6.09	5.00
	87914-2812	-----	-----	-----	28	----	2	35.56	33.02	10.92	5.84	2.79
	87914-2822	-----	-----	-----	28	----	2	35.56	33.02	12.25	7.00	2.96
	87914-2832	-----	-----	-----	28	----	2	35.56	33.02	13.38	6.09	5.00
E	87914-2813	-----	-----	-----	28	----	3	35.56	33.02	10.92	5.84	2.79
	87914-2823	-----	-----	-----	28	----	3	35.56	33.02	12.25	7.00	2.96
	87914-2833	-----	-----	-----	28	----	3	35.56	33.02	13.38	6.09	5.00
	87914-2814	-----	-----	-----	28	----	4	35.56	33.02	10.92	5.84	2.79
	87914-2824	-----	-----	-----	28	----	4	35.56	33.02	12.25	7.00	2.96
	87914-2834	-----	-----	-----	28	----	4	35.56	33.02	13.38	6.09	5.00
D	87914-2815	-----	-----	-----	28	----	5	35.56	33.02	10.92	5.84	2.79
	87914-2825	-----	-----	-----	28	----	5	35.56	33.02	12.25	7.00	2.96
	87914-2835	-----	-----	-----	28	----	5	35.56	33.02	13.38	6.09	5.00
	87914-2816	-----	-----	-----	28	----	6	35.56	33.02	10.92	5.84	2.79
	87914-2826	-----	-----	-----	28	----	6	35.56	33.02	12.25	7.00	2.96
	87914-2836	-----	-----	-----	28	----	6	35.56	33.02	13.38	6.09	5.00
C												
B												

ADD TUBE PK SPEC IEC NO: S2017-0192 DRWN:FC500 CHKD:CG0H APPR:KHLIM	2016/09/28 2016/10/17 2016/10/18	QUALITY SYMBOLS $\nabla = 0$ $\nabla = 0$ $\nabla = 0$	GENERAL TOLERANCES (UNLESS SPECIFIED)		DIMENSION STYLE MM ONLY		SCALE NTS	DESIGN UNITS METRIC	THIRD ANGLE PROJECTION					
					mm	INCH	DRAWN BY KCHO	DATE 2004/11/05	TITLE 2.54MM PITCH DUAL ROW HEADER SINGLE WAFER, T/H					
			4 PLACES	\pm ---	\pm ---	3 PLACES	\pm ---	\pm ---	CHECKED BY PTLIM	DATE 2004/12/08				
			2 PLACES	\pm 0.20	\pm ---	1 PLACE	\pm ---	\pm ---	APPROVED BY MLONG	DATE 2010/09/06				
0 PLACE	\pm	\pm	ANGULAR $\pm 3^\circ$		MATERIAL NO.	DOCUMENT NO.								
DRAFT WHERE APPLICABLE MUST REMAIN WITHIN DIMENSIONS			SEE TABLE		SD-87914-013					SHEET NO. 19 OF 45				





	10	9	8	7	6	5	4	3	2	1				
	PART NO FOR TRAY PACKAGING	PART NO. FOR TUBE WITHOUT CAP PACKAGING	PART NO. FOR TUBE WITH CAP PACKAGING	PART NO. FOR TAPE & REEL WITHOUT CAP PACKAGING	PART NO. FOR TAPE & REEL WITH CAP PACKAGING	CKT SIZE	VOID POSITION	PLATING TYPE	DIMENSION					
								A	B	F	M	P		
F	87914-3011	-----	-----	-----	-----	30	----	1	38.10	35.56	10.92	5.84	2.79	F
	87914-3021	-----	-----	-----	-----	30	----	1	38.10	35.56	12.25	7.00	2.96	
	87914-3031	-----	-----	-----	-----	30	----	1	38.10	35.56	13.38	6.09	5.00	
	87914-3012	-----	-----	-----	-----	30	----	2	38.10	35.56	10.92	5.84	2.79	
	87914-3022	-----	-----	-----	-----	30	----	2	38.10	35.56	12.25	7.00	2.96	
	87914-3032	-----	-----	-----	-----	30	----	2	38.10	35.56	13.38	6.09	5.00	
E	87914-3013	-----	-----	-----	-----	30	----	3	38.10	35.56	10.92	5.84	2.79	E
	87914-3023	-----	-----	-----	-----	30	----	3	38.10	35.56	12.25	7.00	2.96	
	87914-3033	-----	-----	-----	-----	30	----	3	38.10	35.56	13.38	6.09	5.00	
	87914-3014	-----	-----	-----	-----	30	----	4	38.10	35.56	10.92	5.84	2.79	
	87914-3024	-----	-----	-----	-----	30	----	4	38.10	35.56	12.25	7.00	2.96	
	87914-3034	-----	-----	-----	-----	30	----	4	38.10	35.56	13.38	6.09	5.00	
D	87914-3015	-----	-----	-----	-----	30	----	5	38.10	35.56	10.92	5.84	2.79	D
	87914-3025	-----	-----	-----	-----	30	----	5	38.10	35.56	12.25	7.00	2.96	
	87914-3035	-----	-----	-----	-----	30	----	5	38.10	35.56	13.38	6.09	5.00	
	87914-3016	-----	-----	-----	-----	30	----	6	38.10	35.56	10.92	5.84	2.79	
	87914-3026	-----	-----	-----	-----	30	----	6	38.10	35.56	12.25	7.00	2.96	
	87914-3036	-----	-----	-----	-----	30	----	6	38.10	35.56	13.38	6.09	5.00	
C														C
B														B

ADD TUBE PK SPEC IEC NO: S2017-0192 DRW: FCS00 CHKD: CG0H APPR: KHL IM	2016/09/28 2016/10/17 2016/10/18	DESCRIPTION REV	QUALITY SYMBOLS	GENERAL TOLERANCES (UNLESS SPECIFIED)	DIMENSION STYLE	SCALE	DESIGN UNITS	THIRD ANGLE PROJECTION
				mm INCH	MM ONLY	NTS	METRIC	
			$\nabla = 0$ $\nabla = 0$ $\nabla = 0$	4 PLACES ± --- ± --- 3 PLACES ± --- ± --- 2 PLACES ± 0.20 ± --- 1 PLACE ± --- ± --- 0 PLACE ± ±	DRAWN BY DATE KCHO 2004/11/05 CHECKED BY DATE PTL IM 2004/12/08 APPROVED BY DATE MLONG 2010/09/06	TITLE 2.54MM PITCH DUAL ROW HEADER SINGLE WAFER, T/H		
			ANGULAR ± 3 ° DRAFT WHERE APPLICABLE MUST REMAIN WITHIN DIMENSIONS	MATERIAL NO. SEE TABLE	DOCUMENT NO. SD-87914-013	SHEET NO. 20 OF 45		

	10	9	8	7	6	5	4	3	2	1				
	PART NO. FOR TRAY PACKAGING	PART NO. FOR TUBE WITHOUT CAP PACKAGING	PART NO. FOR TUBE WITH CAP PACKAGING	PART NO. FOR TAPE & REEL WITHOUT CAP PACKAGING	PART NO. FOR TAPE & REEL WITH CAP PACKAGING	CKT SIZE	VOID POSITION	PLATING TYPE	DIMENSION					
								A	B	F	M	D		
F	87914-3411	-----	-----	-----	-----	34	----	1	43.18	40.64	10.92	5.84	2.79	F
	87914-3421	-----	-----	-----	-----	34	----	1	43.18	40.64	12.25	7.00	2.96	
	87914-3431	-----	-----	-----	-----	34	----	1	43.18	40.64	13.38	6.09	5.00	
	87914-3412	-----	-----	-----	-----	34	----	2	43.18	40.64	10.92	5.84	2.79	
	87914-3422	-----	-----	-----	-----	34	----	2	43.18	40.64	12.25	7.00	2.96	
	87914-3432	-----	-----	-----	-----	34	----	2	43.18	40.64	13.38	6.09	5.00	
E	87914-3413	-----	-----	-----	-----	34	----	3	43.18	40.64	10.92	5.84	2.79	E
	87914-3423	-----	-----	-----	-----	34	----	3	43.18	40.64	12.25	7.00	2.96	
	87914-3433	-----	-----	-----	-----	34	----	3	43.18	40.64	13.38	6.09	5.00	
	87914-3414	-----	-----	-----	-----	34	----	4	43.18	40.64	10.92	5.84	2.79	
	87914-3424	-----	-----	-----	-----	34	----	4	43.18	40.64	12.25	7.00	2.96	
	87914-3434	-----	-----	-----	-----	34	----	4	43.18	40.64	13.38	6.09	5.00	
D	87914-3415	-----	-----	-----	-----	34	----	5	43.18	40.64	10.92	5.84	2.79	D
	87914-3425	-----	-----	-----	-----	34	----	5	43.18	40.64	12.25	7.00	2.96	
	87914-3435	-----	-----	-----	-----	34	----	5	43.18	40.64	13.38	6.09	5.00	
	87914-3416	-----	-----	-----	-----	34	----	6	43.18	40.64	10.92	5.84	2.79	
	87914-3426	-----	-----	-----	-----	34	----	6	43.18	40.64	12.25	7.00	2.96	
	87914-3436	-----	-----	-----	-----	34	----	6	43.18	40.64	13.38	6.09	5.00	
C														C
B														B

ADD TUBE PK SPEC IEC NO: S2017-0192 DRW: FCS00 CHKD: CG0H APPR: KHL IM	2016/09/28 2016/10/17 2016/10/18	DESCRIPTION REV	QUALITY SYMBOLS	GENERAL TOLERANCES (UNLESS SPECIFIED)	DIMENSION STYLE	SCALE	DESIGN UNITS	THIRD ANGLE PROJECTION		
					MM ONLY	NTS	METRIC			

PART NO FOR TRAY PACKAGING	PART NO. FOR TUBE WITHOUT CAP PACKAGING	PART NO. FOR TUBE WITH CAP PACKAGING	PART NO. FOR TAPE & REEL WITHOUT CAP PACKAGING	PART NO. FOR TAPE & REEL WITH CAP PACKAGING	CKT SIZE	VOID POSITION	PLATING TYPE	DIMENSION				
								A	B	F	M	P
								F	87914-4011	-----	-----	-----
	87914-4021	-----	-----	-----	40	----	1	50.80	48.26	12.25	7.00	2.96
	87914-4031	-----	-----	-----	40	----	1	50.80	48.26	13.38	6.09	5.00
	87914-4012	-----	-----	-----	40	----	2	50.80	48.26	10.92	5.84	2.79
	87914-4022	-----	-----	-----	40	----	2	50.80	48.26	12.25	7.00	2.96
	87914-4032	-----	-----	-----	40	----	2	50.80	48.26	13.38	6.09	5.00
E	87914-4013	-----	-----	-----	40	----	3	50.80	48.26	10.92	5.84	2.79
	87914-4023	-----	-----	-----	40	----	3	50.80	48.26	12.25	7.00	2.96
	87914-4033	-----	-----	-----	40	----	3	50.80	48.26	13.38	6.09	5.00
	87914-4014	-----	-----	-----	40	----	4	50.80	48.26	10.92	5.84	2.79
	87914-4024	-----	-----	-----	40	----	4	50.80	48.26	12.25	7.00	2.96
	87914-4034	-----	-----	-----	40	----	4	50.80	48.26	13.38	6.09	5.00
D	87914-4015	-----	-----	-----	40	----	5	50.80	48.26	10.92	5.84	2.79
	87914-4025	-----	-----	-----	40	----	5	50.80	48.26	12.25	7.00	2.96
	87914-4035	-----	-----	-----	40	----	5	50.80	48.26	13.38	6.09	5.00
	87914-4016	-----	-----	-----	40	----	6	50.80	48.26	10.92	5.84	2.79
	87914-4026	-----	-----	-----	40	----	6	50.80	48.26	12.25	7.00	2.96
	87914-4036	-----	-----	-----	40	----	6	50.80	48.26	13.38	6.09	5.00
C												
B												

ADD TUBE PK SPEC IEC NO: S2017-0192 DRWN:FC500 2016/09/28 CHKD:CG0H 2016/10/17 APPR:KHLIM 2016/10/18	QUALITY SYMBOLS  =0  =0  =0	GENERAL TOLERANCES (UNLESS SPECIFIED)		DIMENSION STYLE MM ONLY		SCALE NTS	DESIGN UNITS METRIC	 THIRD ANGLE PROJECTION	
				mm	INCH	DRAWN BY KCHO	DATE 2004/11/05		TITLE 2.54MM PITCH DUAL ROW HEADER SINGLE WAFER, T/H
				4 PLACES ± ---	± ---	CHECKED BY PTLIM	DATE 2004/12/08	molex	DOCUMENT NO. SD-87914-013
				3 PLACES ± ---	± ---	APPROVED BY MLONG	DATE 2010/09/06		
		2 PLACES ± 0.20	± ---	MATERIAL NO.		SHEET NO. 25 OF 45			
		1 PLACE ± ---	± ---	SEE TABLE		THIS DRAWING CONTAINS INFORMATION THAT IS PROPRIETARY TO MOLEX INCORPORATED AND SHOULD NOT BE USED WITHOUT WRITTEN PERMISSION			
		0 PLACE ±	±	DRAFT WHERE APPLICABLE MUST REMAIN WITHIN DIMENSIONS					

