

Frequency Divider Evaluation Board

ABLNO-EVAL

 **RoHS Compliant**

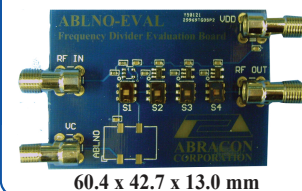

OVERALL CAPABILITY

ABLNO-EVAL; Frequency Divider Evaluation Board shown in figure (1) is designed to facilitate engineering evaluation of Abracon's Ultra Low Noise – ABLNO series of fixed clock and voltage controlled crystal oscillators. Further, there is a provision through the RF_IN SMA Connector to supply any other oscillator signal between 10MHz and 200MHz; if ABLNO series is not being characterized.

This Evaluation Board is ideal to conduct the following measurements:

- Phase Noise and rms jitter for $\div 1$, $\div 2$, $\div 4$ and $\div 8$ frequency outputs
- Frequency Pull Characteristics of the ABLNO by using the Vc port as the control voltage
- Frequency Stability over operating temperature (-40°C to $+85^{\circ}\text{C}$)



Figure (1)

Designers who are interested in using the ABLNO as an Ultra Low Noise platform device to generate additional Low Noise frequencies will find this Evaluation Board to be of exceptional value. Abracon has implemented Ultra Low Noise $\div 2$, $\div 4$ and $\div 8$ circuitry on this board, that can also be incorporated in end-customer solutions; please contact tech-spport@abracon.com for additional details.

Typical Phase Noise and jitter performance in $\div 1$, $\div 2$, $\div 4$ and $\div 8$ modes is depicted in section 2.0.

Frequency Divider Evaluation Board

ABLNO- EVAL

 **RoHS Compliant**

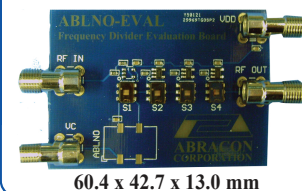

COMPONENT DESCRIPTION

Component	Description	Functionality
RF_IN	External Oscillator Input	Input a 10MHz to 200MHz oscillator signal into this SMA connector for evaluation... <i>see Note #5</i>
Vc	Control Port	When characterizing the ABLNO series of VCXO's, apply control voltage to this port to characterize frequency pull
VDD	Supply Voltage	This port simultaneously biases the ABLNO Oscillator and the divider scheme (+3.3V ±5%) <i>see Note #4</i>
RF_Out	Evaluation Board Output	Either ABLNO or RF_IN frequency is divided down by 1, 2, 4 or 8 and is present at this port
S1	Switch # 1	If the tab is moved to the “up position (UP)”, RF_IN signal is selected. If the tab is moved to the “down position (DN)”, ABLNO signal is selected
S2	Switch # 2	If the tab is moved to the “up position (UP)”, RF_IN signal is divided down by 2 and is present at RF_Out
S3	Switch # 3	If the tab is moved to the “up position (UP)”, RF_IN signal is divided down by 4 and is present at RF_Out. S2 should also be in the “up position (UP)”... please see truth table #1
S4	Switch # 4	If the tab is moved to the “up position (UP)”, RF_IN signal is divided down by 8 and is present at RF_Out. S2 & S3 should also be in the “up position (UP)”... please see truth table #1

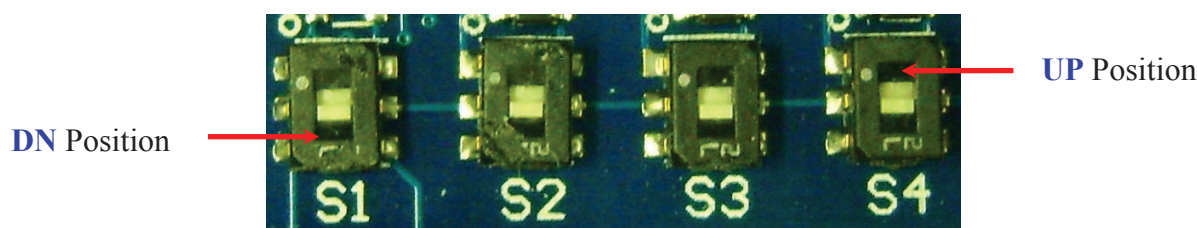
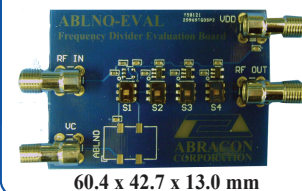

Figure (2)

Frequency Divider Evaluation Board

ABLNO-EVAL

 **RoHS Compliant**



TRUTH TABLE

Table # 1

S1	S2	S3	S4	Description
DN	DN	DN	DN	ABLNO's RF Output = ÷1
DN	UP	DN	DN	ABLNO's RF Output = ÷2
DN	UP	UP	DN	ABLNO's RF Output = ÷4
DN	UP	UP	UP	ABLNO's RF Output = ÷8

Table # 2

S1	S2	S3	S4	Description
UP	DN	DN	DN	RF_IN Port's RF Output = ÷1
UP	UP	DN	DN	RF_IN Port's RF Output = ÷2
UP	UP	UP	DN	RF_IN Port's RF Output = ÷4
UP	UP	UP	UP	RF_IN Port's RF Output = ÷8

Note # 1: **DN** = Down Position; **UP** = Up Position

Note # 2: All four switches are shipped with yellow protective tape on top, please remove before use

Note # 3: To evaluate Abracon's ABLNO Crystal Oscillator, please solder it down in the section outlined with a rectangle and labeled ABLNO. Please follow the orientation shown in figure (3) below.

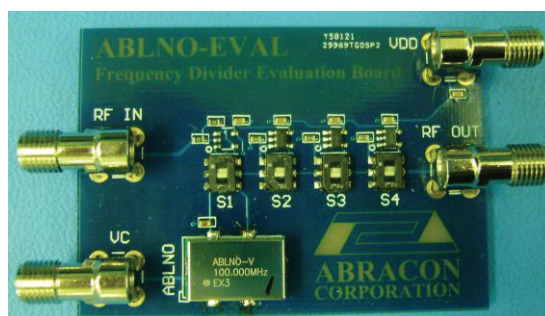

Figure (3)

Note # 4: VDD Port biases both the ABLNO device, as well as the divider circuitry. Since ABLNO's VDD range is $+3.3V \pm 5\%$, the recommended VDD range while evaluating ABLNO oscillators is $+3.135V$ to $+3.465V$. However, since the divider circuitry can be biased between $+1.8V$ & $+5.5V$, while evaluating RF_IN external signal; lower or higher biasing voltage can be used, as long as the peak-to-peak signal from the RF_IN port does not exceed the bias voltage (VDD).

Note # 5: RF_IN port expects a LVCMOS signal. If a clipped Sinewave or Sinewave signal with lower amplitude is used; it might be necessary to square-that-up. There is a provision above (S1) to add a buffer to achieve this. Please contact tech-support@abracon.com.

Frequency Divider Evaluation Board

ABLNO-EVAL

 **RoHS Compliant**

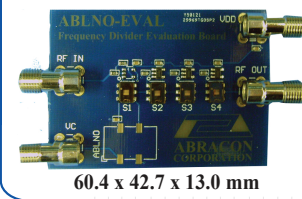

100MHz ABLNO was used to conduct $\div 1$, $\div 2$, $\div 4$ and $\div 8$ measurements

Typical Phase Noise Performance @ 100.00 MHz Carrier ($\div 1$ Mode) @ Vdd = +3.3V (25°C \pm 3°C)

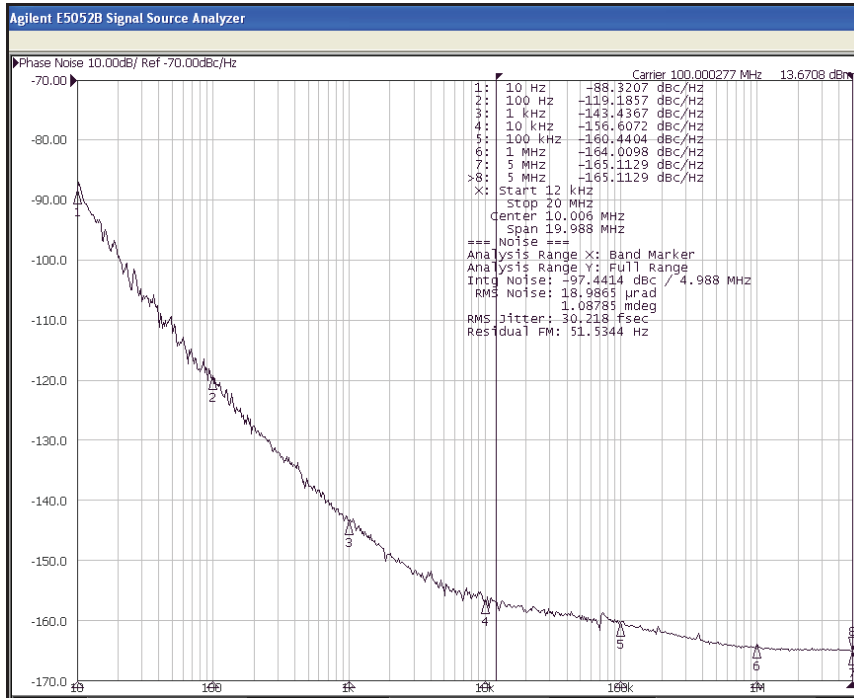

S1	S2	S3	S4	Description
DN	DN	DN	DN	ABLNO's RF Output = $\div 1$

Typical Phase Noise Performance @ 50.00 MHz Carrier ($\div 2$ Mode) @ Vdd = +3.3V (25°C \pm 3°C)

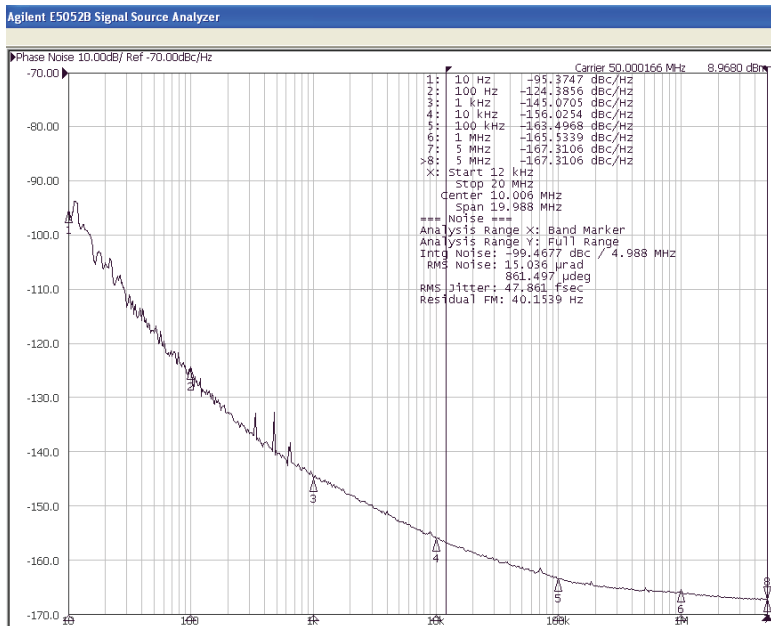

S1	S2	S3	S4	Description
DN	UP	DN	DN	ABLNO's RF Output = $\div 2$

ABRACON IS
ISO9001:2008
CERTIFIED



Visit www.abracon.com for Terms & Conditions of Sale **Revised: 06.06.13**

30332 Esperanza, Rancho Santa Margarita, California 92688

tel 949-546-8000 | fax 949-546-8001 | www.abracon.com

Frequency Divider Evaluation Board

ABLNO-EVAL

 **RoHS Compliant**

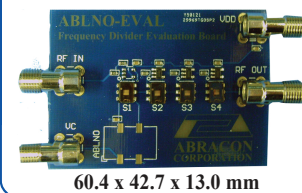

Typical Phase Noise Performance @ 25.00 MHz Carrier ($\div 4$ Mode) @ Vdd = +3.3V (25°C \pm 3°C)

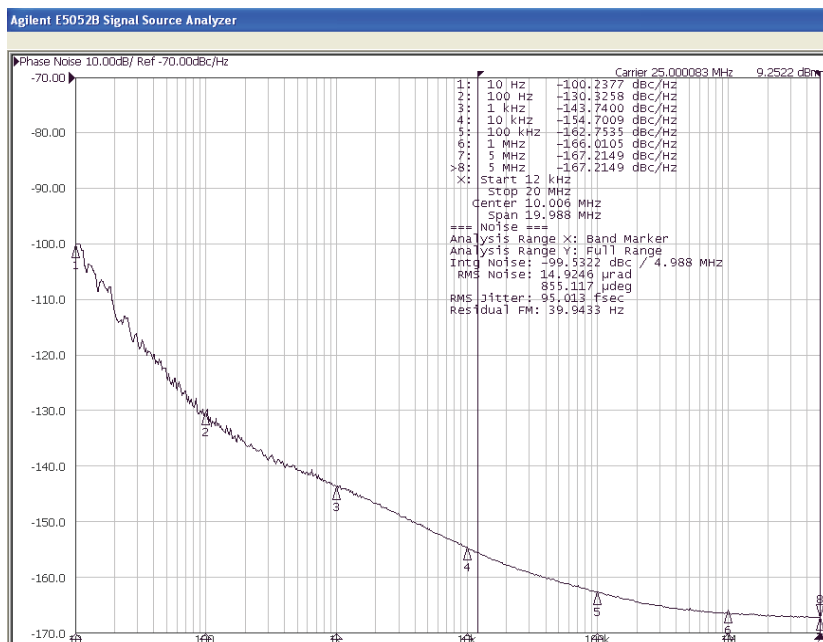

S1	S2	S3	S4	Description
DN	UP	UP	DN	ABLNO's RF Output = $\div 4$

Typical Phase Noise Performance @ 12.50 MHz Carrier ($\div 8$ Mode) @ Vdd = +3.3V (25°C \pm 3°C)

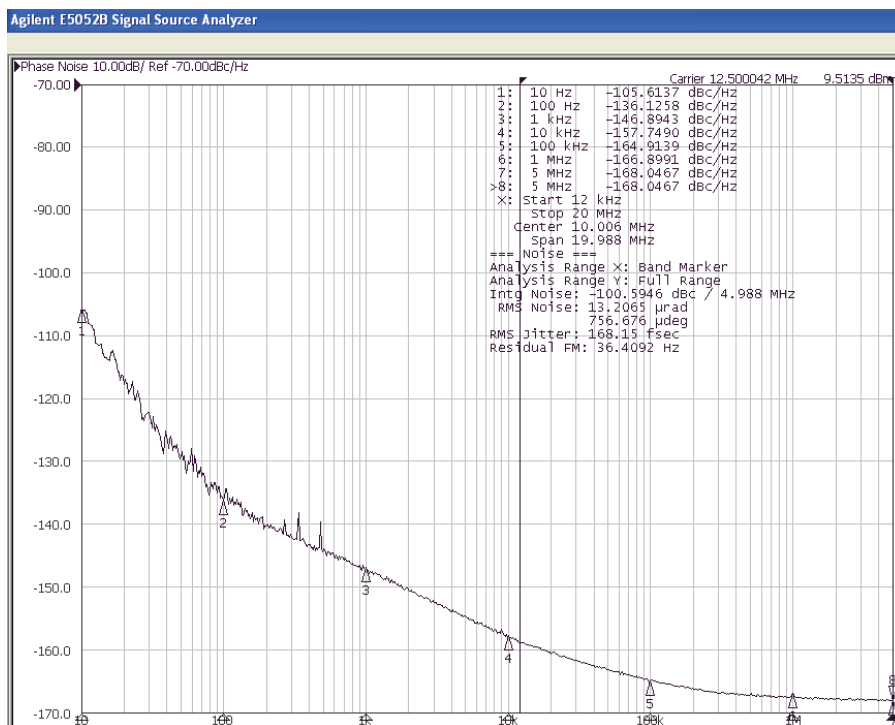

S1	S2	S3	S4	Description
DN	UP	UP	UP	ABLNO's RF Output = $\div 8$

Frequency Divider Evaluation Board

ABLNO-EVAL

 **RoHS Compliant**

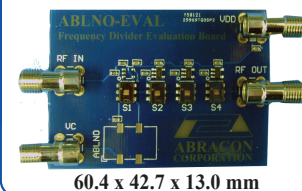

PHASE NOISE & RMS JITTER PERFORMANCE SUMMARY

Offset From the Carrier	Measured Phase Noise (dBc/Hz)			
	100MHz	50MHz	25MHz	12.5MHz
10Hz	-88.32	-95.38	-100.24	-105.61
100Hz	-119.16	-124.38	-130.33	-136.13
1,000Hz	-143.44	-145.07	-143.74	-146.90
10,000Hz	-156.60	-156.02	-154.70	-157.75
100,000Hz	-160.44	-163.50	-162.75	-164.90
1,000,000Hz	-164.00	-165.54	-166.01	-166.90
5,000,000Hz	-165.11	-167.31	-167.21	-168.04

Carrier	100MHz	50MHz	25MHz	12.5MHz
Measured Jitter (12kHz to 20MHz) in <i>femto seconds</i>	30.22	47.86	95.01	168.15
<i>Additive rms Jitter</i> (12kHz to 20MHz) in <i>femto seconds</i>		17.64	64.80	137.93

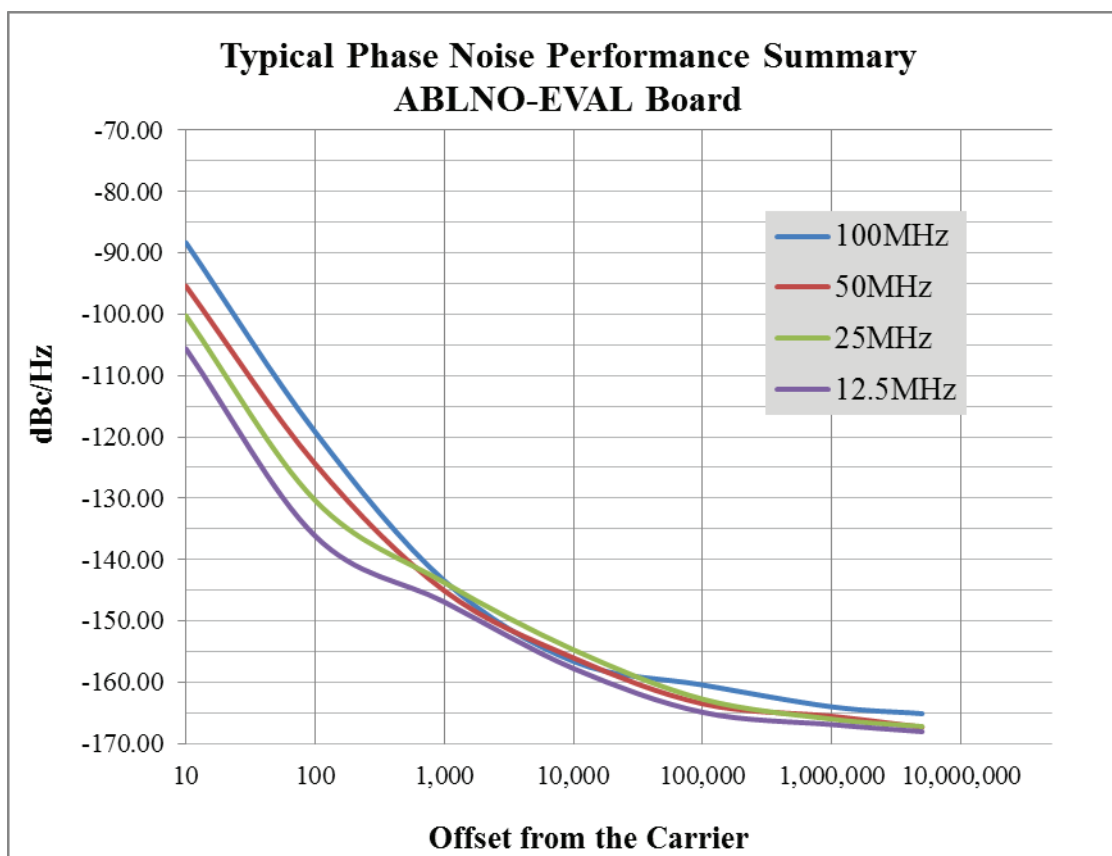

Frequency Divider Evaluation Board

ABLNO-EVAL

 **RoHS Compliant**

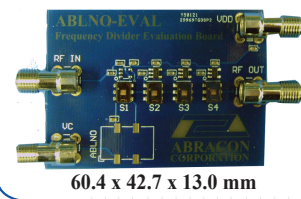

➤ OUTLINE DIMENSION:

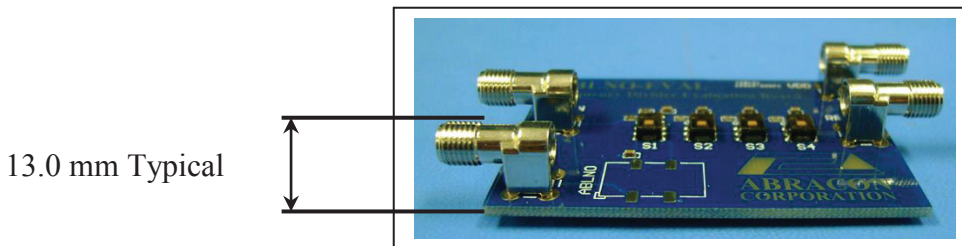
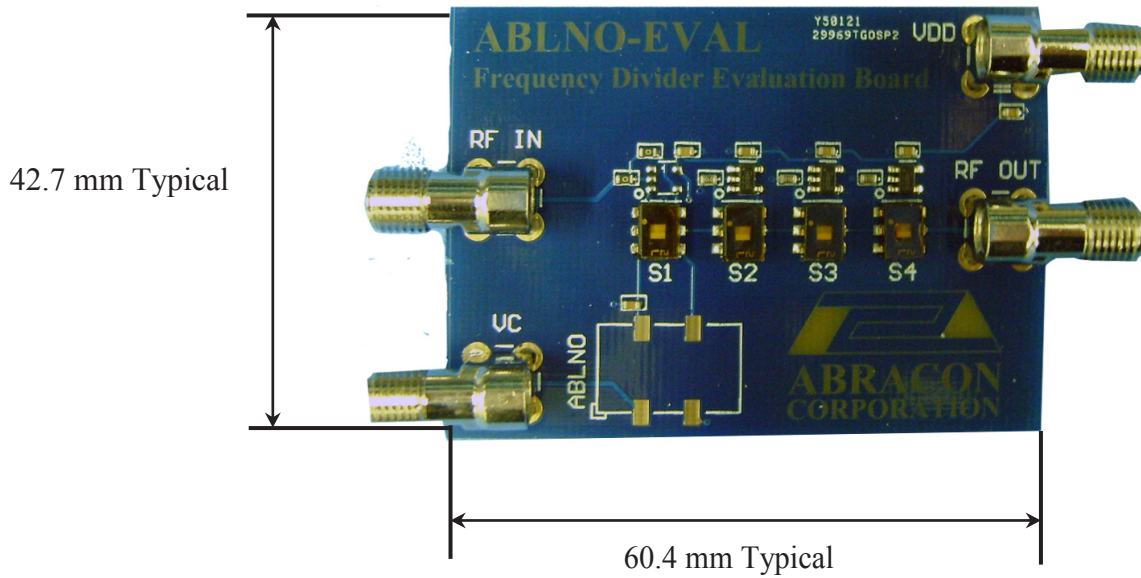

Packaging: Units are packaged in ESD bags, single unit per bag.

ATTENTION: Abracon Corporation's products are COTS – Commercial-Off-The-Shelf products; suitable for Commercial, Industrial and, where designated, Automotive Applications. Abracon's products are not specifically designed for Military, Aviation, Aerospace, Life-dependant Medical applications or any application requiring high reliability where component failure could result in loss of life and/or property. For applications requiring high reliability and/or presenting an extreme operating environment, written consent and authorization from Abracon Corporation is required. Please contact Abracon Corporation for more information.

ABRACON IS
ISO9001:2008
CERTIFIED



Visit www.abracon.com for Terms & Conditions of Sale **Revised: 06.06.13**
30332 Esperanza, Rancho Santa Margarita, California 92688
tel 949-546-8000 | fax 949-546-8001 | www.abracon.com