

SPECIFICATION

Part No. : **AP.35A.07.0054A**

Product Name : 35mm One Stage GPS/GALILEO Active Patch
Antenna Module with back-end Saw Filter

Features : 35*35*3.5mm (Ground Plane)
54mm Ø1.13 I-PEX MHFI (U.FL)
15dB LNA
RoHS Compliant

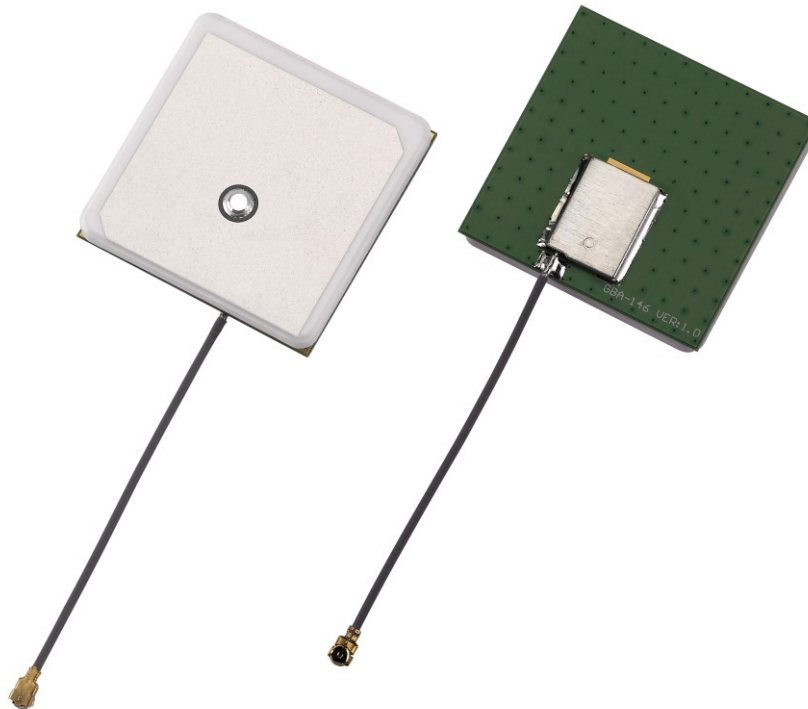

1. Introduction

The AP.35A has been designed for embedded (inside device) integration with GPS receiver modules, the AP.35A combines a 35*35*3.5mm advanced low profile ceramic patch antenna with a one stage LNA and ultra thin coaxial cable.

The Ground Plane size of 35*35mm combined with the larger size GPS Patch, gives this solution a performance increase in gain of 1~2dB. It also helps shields the patch antenna from noise and increases performance at low elevations.. Taoglas active antenna modules utilise XtremeGain™ technology for the highest sensitivity in the industry.

This antenna system consists of two functional blocks, the LNA portion and the patch antenna. The AP.35A has a back-end SAW filter.

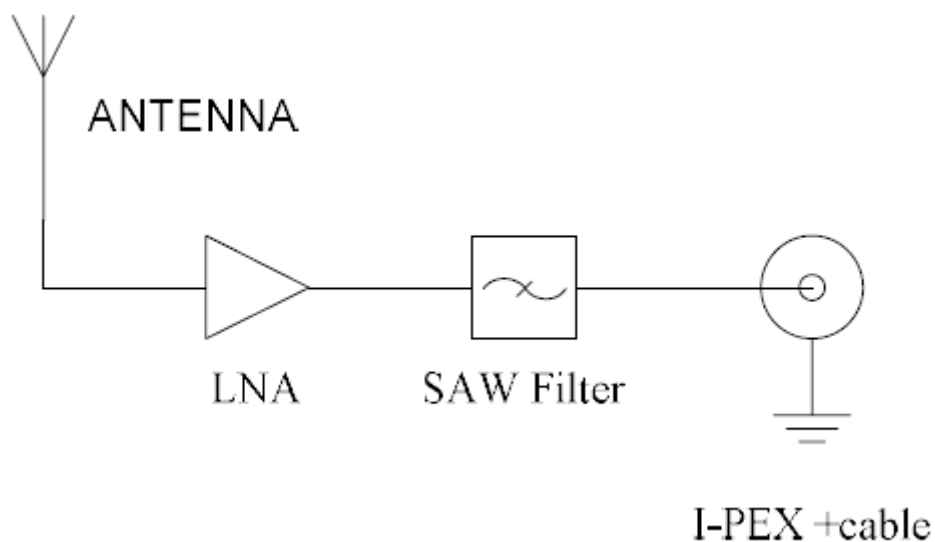

2. Specification

2.1. Patch Antenna

Parameter	Specification
Frequency	1575.42 ± 1.023MHz
Gain @ Zenith	+2.5 dBic Typ. @ Zenith (35mm GP)
Polarization	RHCP
Axial Ratio	3.0dB max. @Zenith
Patch Dimension	35*35*3.5mm

2.2 LNA

Parameter	Specification		
Frequency	1575.42 ± 1.023MHz		
Outer Band Attenuation	F0=1575.42MHz		
	F0±30MHz 5dB min.		
	F0±50MHz 23dB min.		
	F0±100MHz 28dB min.		
Output Impedance	50Ω		
Output VSWR	2.0 Max		
Pout at 1dB Gain Compression point	Typ. -2dBm Min. -6dBm		
LNA Gain, Power Consumption and Noise Figure			
	LNA Gain (Typ)	Power Consumption(mA) Typ	Noise Figure Typ
Min. 1.8V	14dB	3mA	1.5dB
Typ. 3.0V	15dB	3mA	1.5dB
Max. 5.5V	15dB	3mA	1.5dB

2.2. Cable & Connector

Parameter	Specification
RF Cable	Coaxial Cable $\varnothing 1.13 \pm 0.1\text{mm}$, length $54 \pm 2.5\text{mm}$
Connector	IPEX MHFI (U.FL)



2.3. Total Specification (through Antenna, LNA, Cable and Connector)

Parameter	Specification
Frequency	$1575.42 \pm 1.023\text{MHz}$
Gain	At 90° At 5V: $18 \pm 3\text{dBic}$ At 3V: $17.5 \pm 3\text{dBic}$ At 1.8V: $15.5 \pm 3\text{dBic}$
Output Impedance	50Ω
Polarization	RHCP
Output VSWR	Max 2.0
Operation Temperature	-40°C to $+ 85^{\circ}\text{C}$
Storage Temperature	-40°C to $+ 85^{\circ}\text{C}$
Relative Humidity	40% to 95%
Input Voltage	Min:1.8V Typ. 3.0V Max:5V
Antenna	$35*35*5.5\text{mm}$

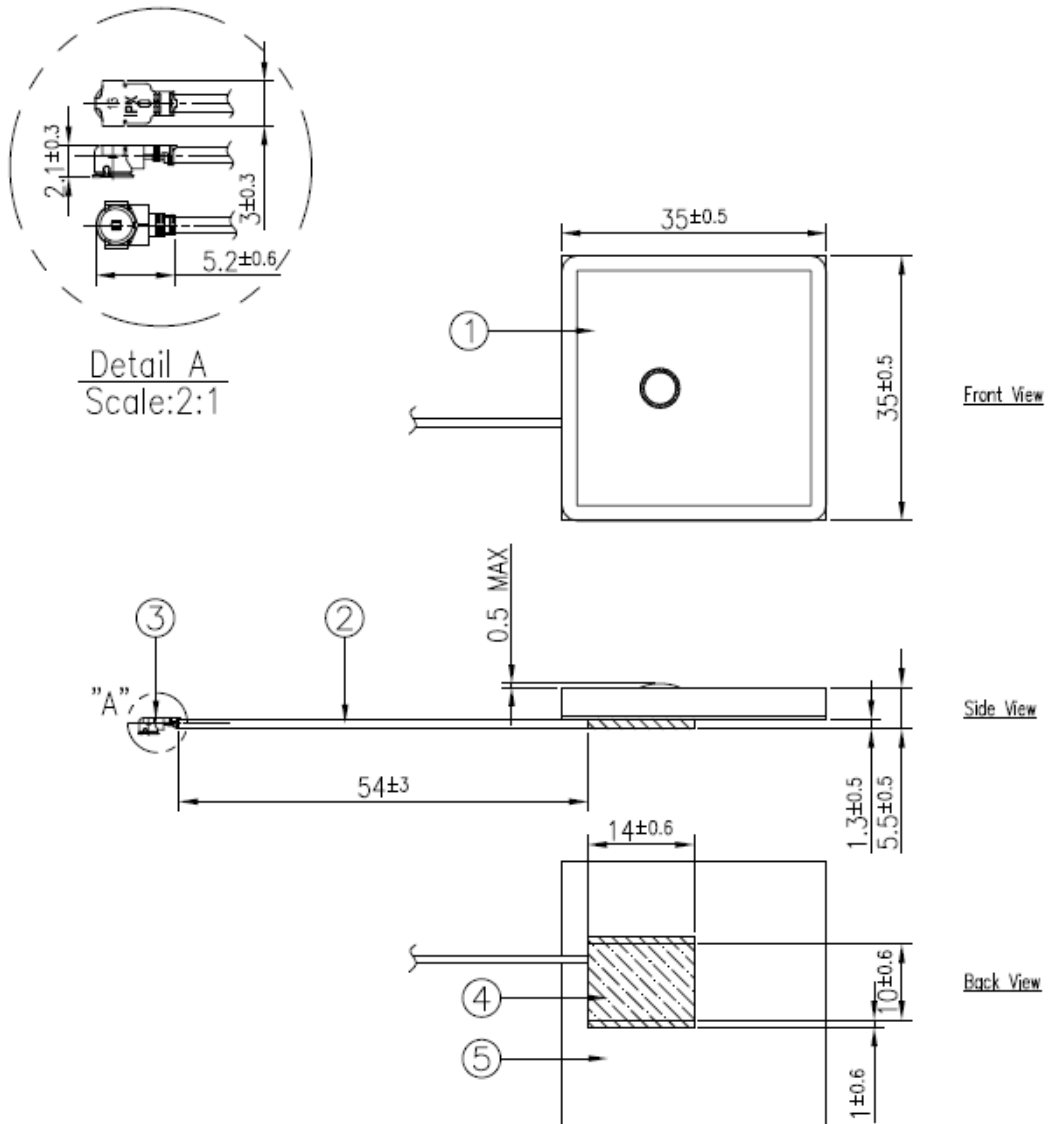
3. Technical Drawing



NOTES:

- 1. Soldered area 
- 2. Shielding case area 
- 3. All material must be RoHS compliant.
- 4. The connector orientation has a fixed position to the antenna as per drawing.

	Name	P/N	Material	Finish	QTY
1	AP.35A Patch(35*35*3.5mm)	001517C120000A	Ceramic	Clear	1
2	1.13 Coaxial Cable	300115C010000A	FEP	Gray	1
3	IPEX MHF1	204111G000000A	Brass	Au Plated	1
4	Shielding Case	000517C010000A	SPTe	Sn Plated	1
5	AP.35A PCB	100217C060000A	Composite 0.5t	Green	1

4. Radiation Patterns

XY Plane

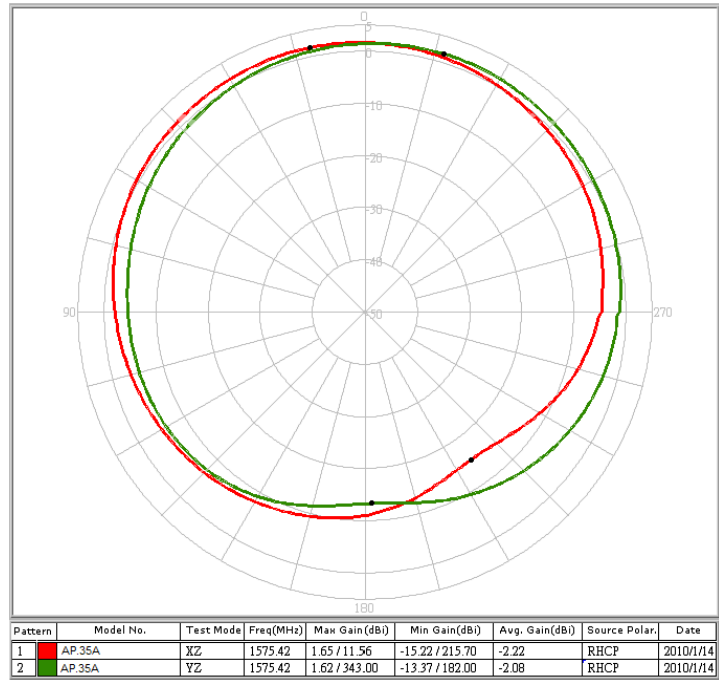

XZ Plane

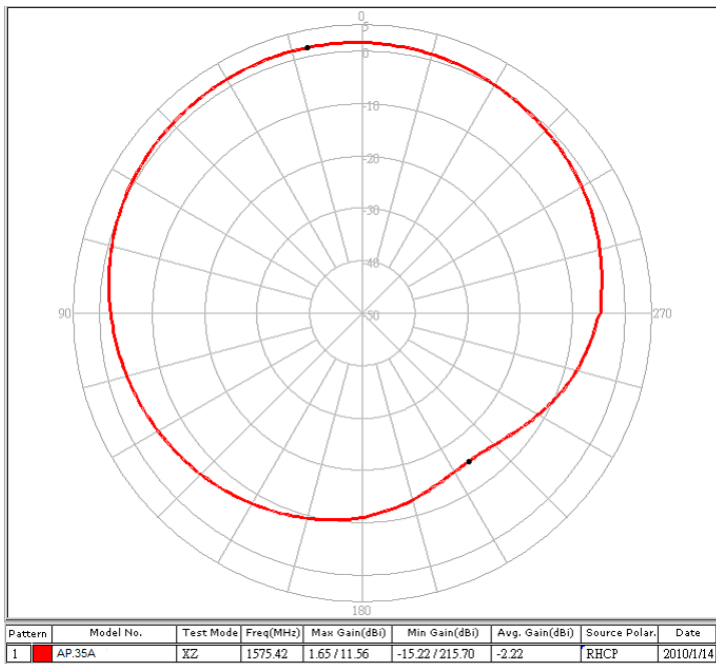

YZ Plane

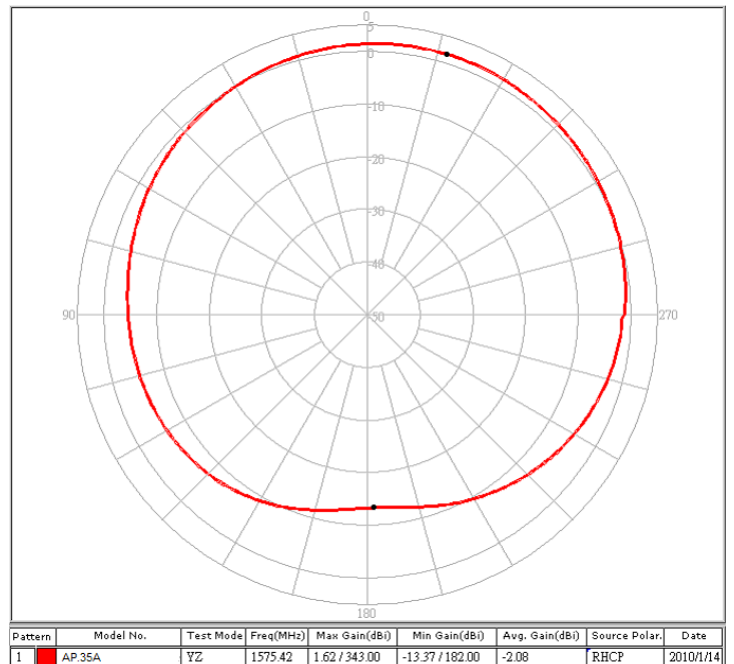

5. Axial Ratio

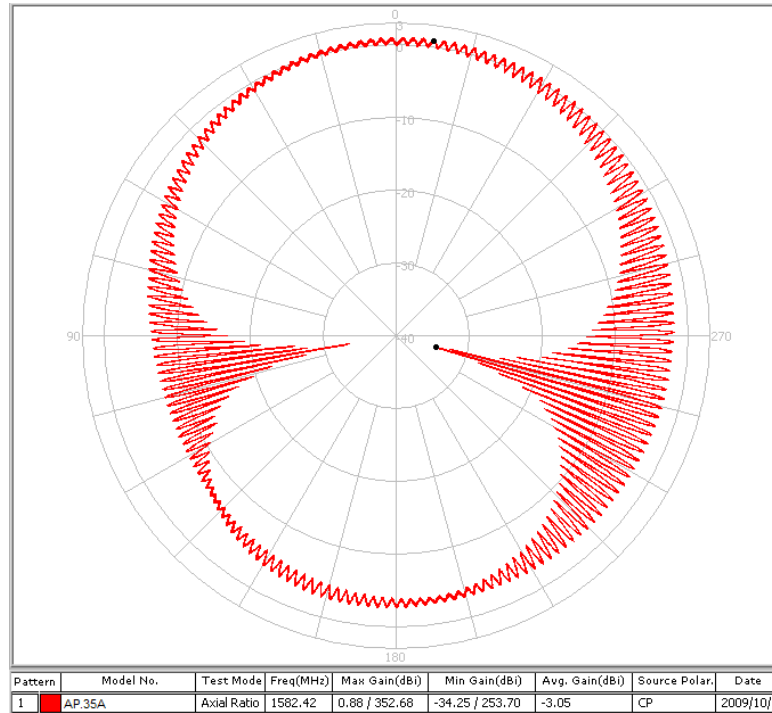

6. LNA Gain and Out of Band Rejection at 3.0V

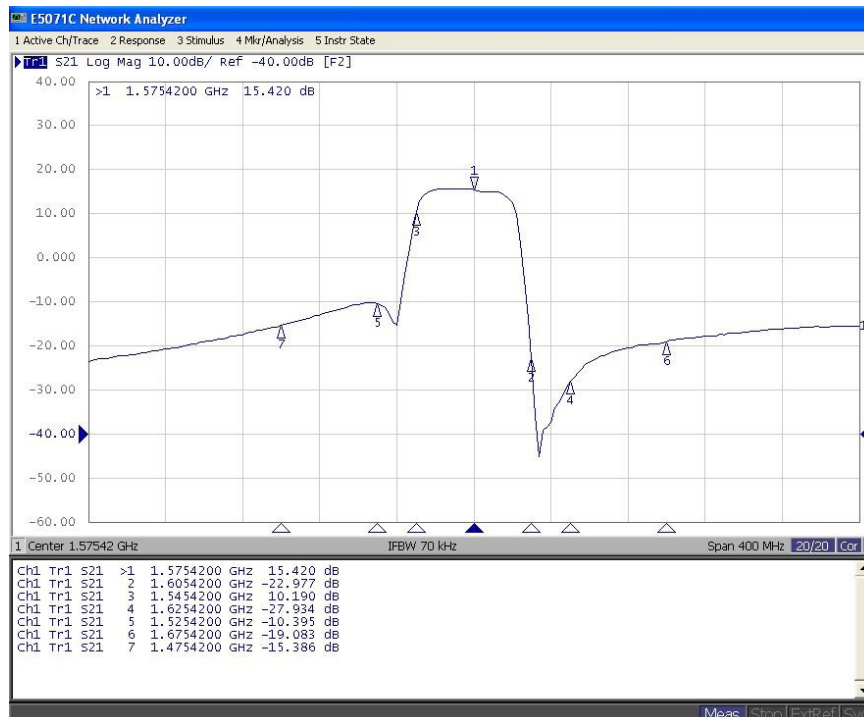

6. LNA Noise Figure at 3.0V

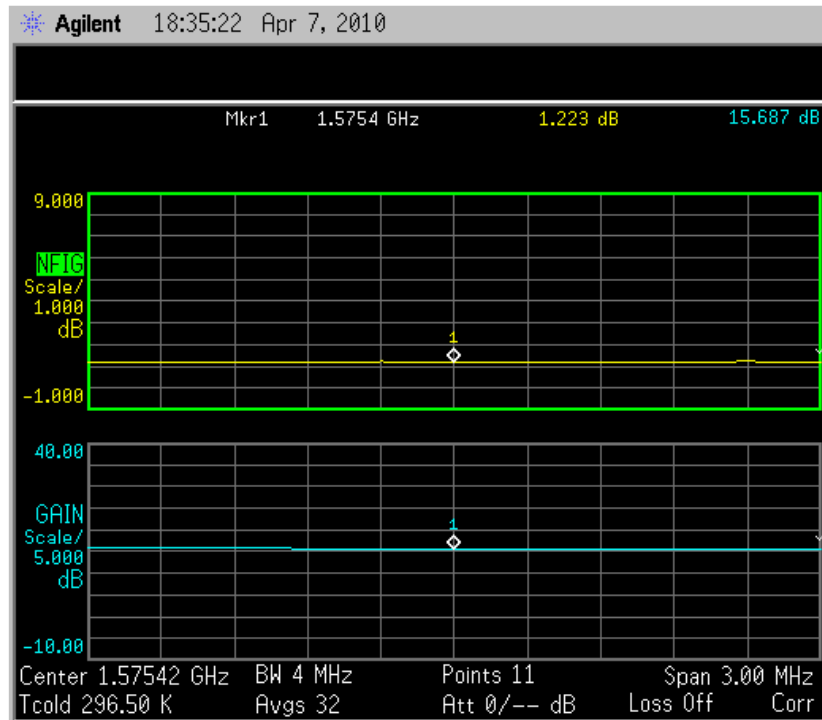

7. Reliability Tests

7.1. Reliability Test (Room temperature +25°C)

7.1.1. S21 Radiation Gain at +25°C

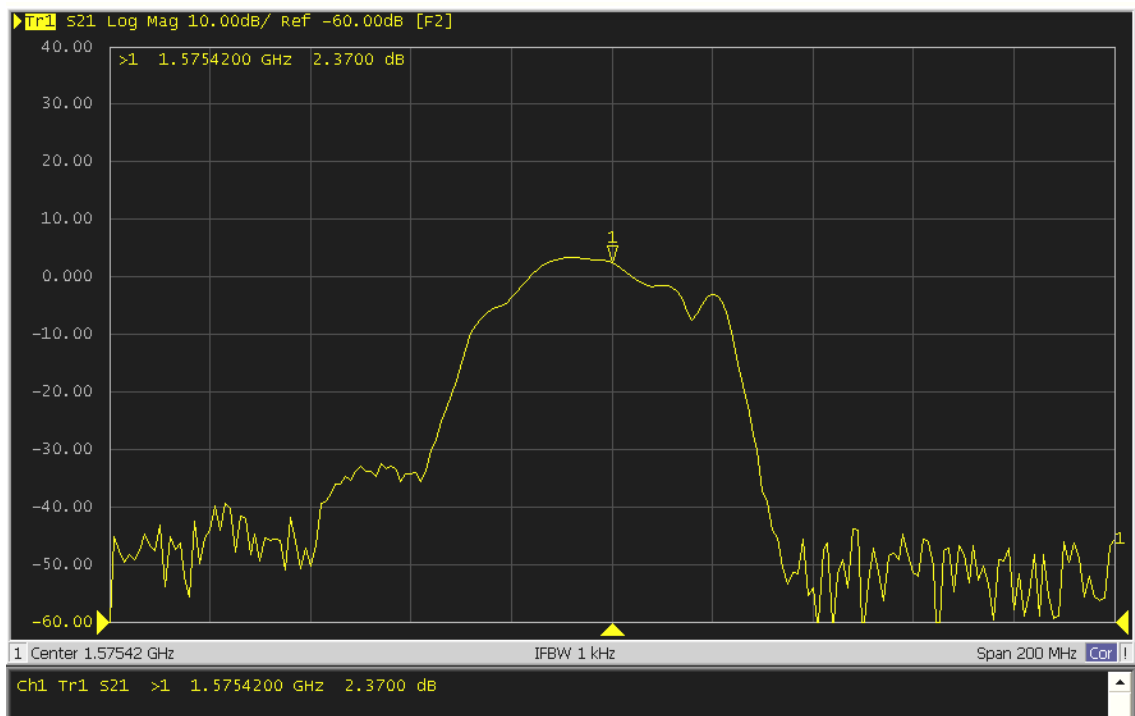

7.1.2. C/N at +25°C

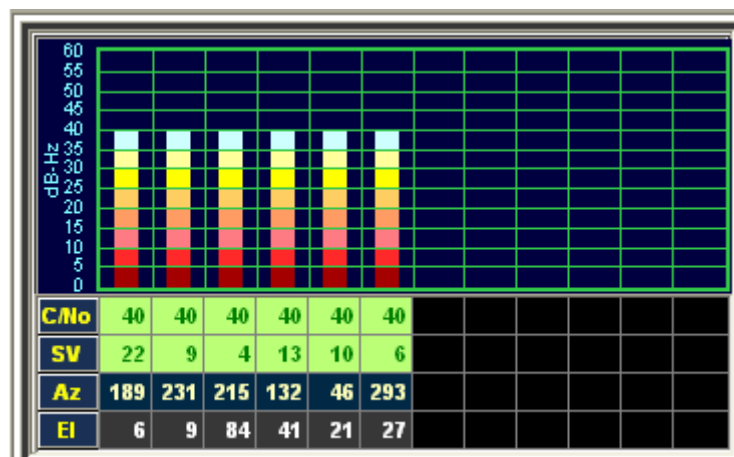

7.2. Reliability Test (High temperature +85°C)

7.2.1. S21 Radiation Gain at +85°C

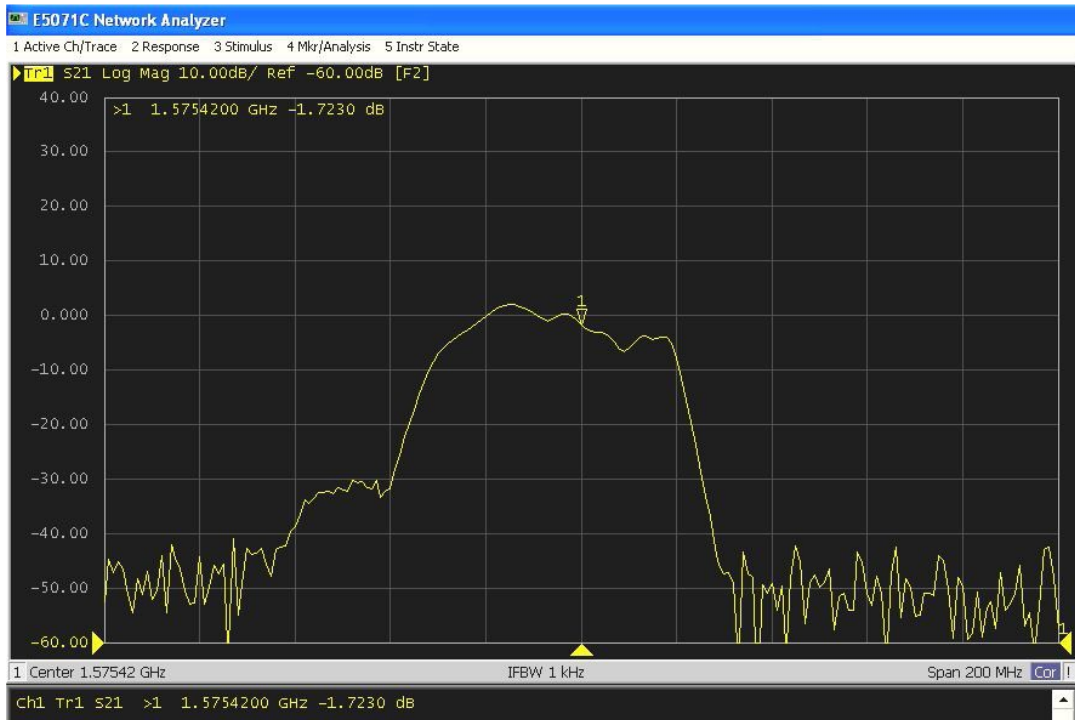

7.2.2. C/N at +85°C

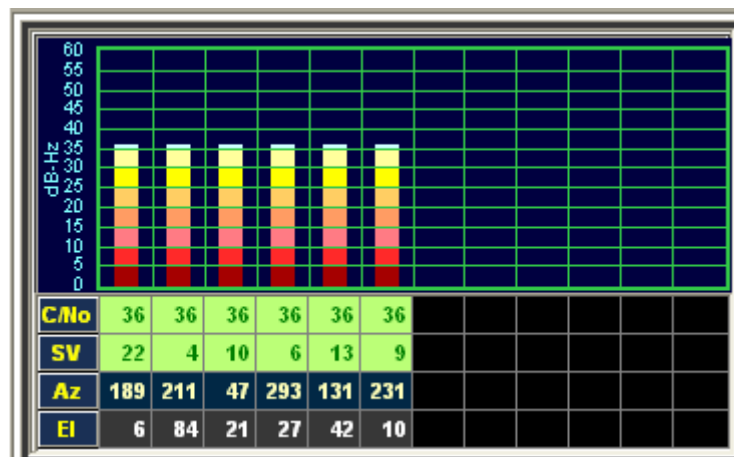

7.3. Reliability Test (Low temperature -40°C)

7.3.1. S21 Radiation Gain at -40°C

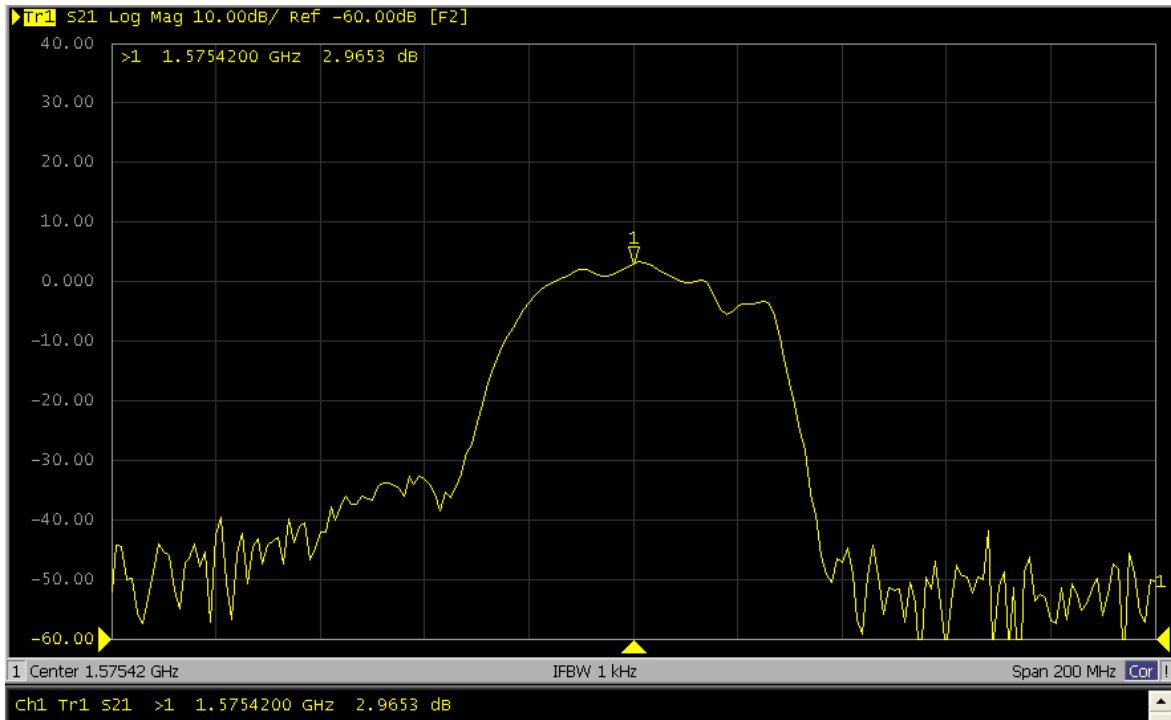

7.3.2. C/N at -40°C

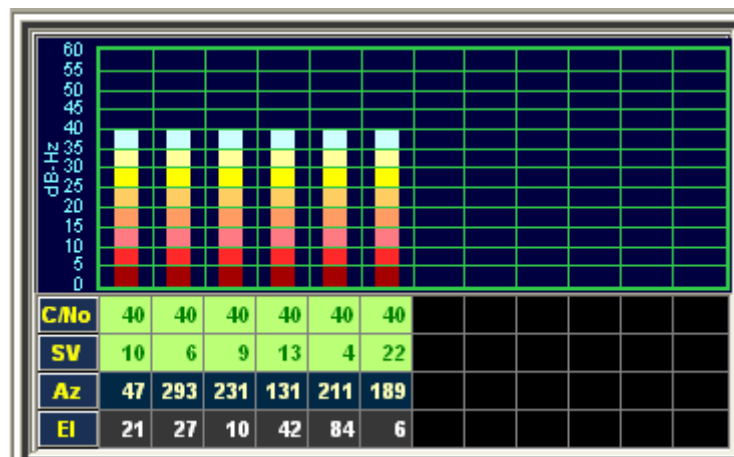

Taoglas makes no warranties based on the accuracy or completeness of the contents of this document and reserves the right to make changes to specifications and product descriptions at any time without notice. Taoglas reserves all rights to this document and the information contained herein.

Reproduction, use or disclosure to third parties without express permission is strictly prohibited.

Copyright © Taoglas Ltd.