

## General Description

Based on flyback topology, the AP3785T EV1 board is designed to serve as an example for high efficiency, cost-effective & components less, flexible power design consumer home appliance systems and charger adopter application. It works under Pulse Frequency Modulation method & employed with a primary side regulated mode, and operating at a Valley switching on region, offering an extreme lower standby input power consumption. Its output power is rated at 15W with 5.0V-3A. This EV1 board meets DOE VI and CoC Tier 2 energy efficiency requirements. An USB Type C connector is at output side for powering & charging any interface related device & system.

## Key Features

- 90 ~265V<sub>AC</sub> universal AC input range
- No required any Opto-Coupler needed & its switching frequency is at 20Khz ~ 80Khz.
- The output drawn current will be depended on ender user device, its max current is 3A.
- By mean of using an integrated within a low R<sub>ds-on</sub> MosFet APR34309 SR drive IC & as well operating at Valley-on switching mode, so the power supply converting efficiency is improved up to 85% Efficiency.
- During the burst mode operation, the 10mW low standby input power can be achieved.
- Very low start-up operating and quiescent currents
- Soft start during startup process.
- Provide accurate constant voltage regulation (CV mode) & accurate constant current (CC).
- Provide the cable drop compensation and adjustable line voltage compensation.
- Built-in Jittering Frequency function is built in to reduce EMI emission.
- There is a transformer saturation protection via primary peak current limitation.
- Internal Auto Recovery OCP, OVP, OLP, OTP Power Protection, cycle by cycle current limit, also within the DC polarity protection

## Applications

- Switching AC-DC Adaptor & Charger
- Power home Appliances systems

## Universal AC input type C 5V-3A PSU Specifications (CV & CC mode)

Parameter	Value
Input Voltage	90 to 265V <sub>AC</sub>
Input standby power	Less than 30 mW
Main output Vo / Io	5V – 3A
Efficiency	>85%
Total Output Power	15W
Protections	OCP, OVP, OLP, OTP
XYZ Dimension	50.40 x 36.0 x 18 mm
ROHS Compliance	Yes
Connector type	Type C 3.0 connector

## Evaluation Board Picture: (will be updated)

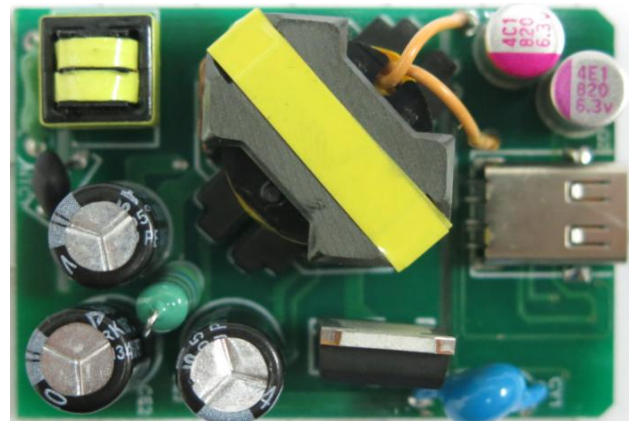

Figure 1: Top View

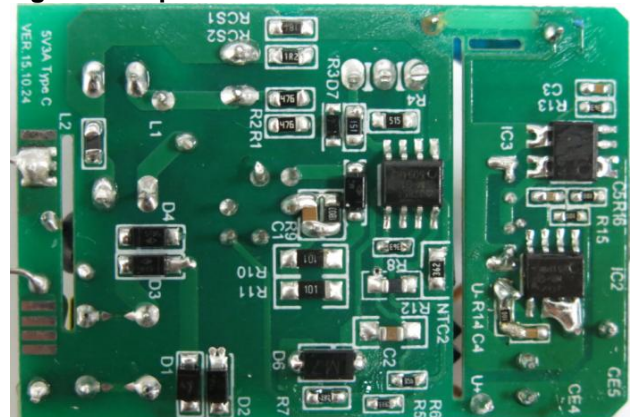
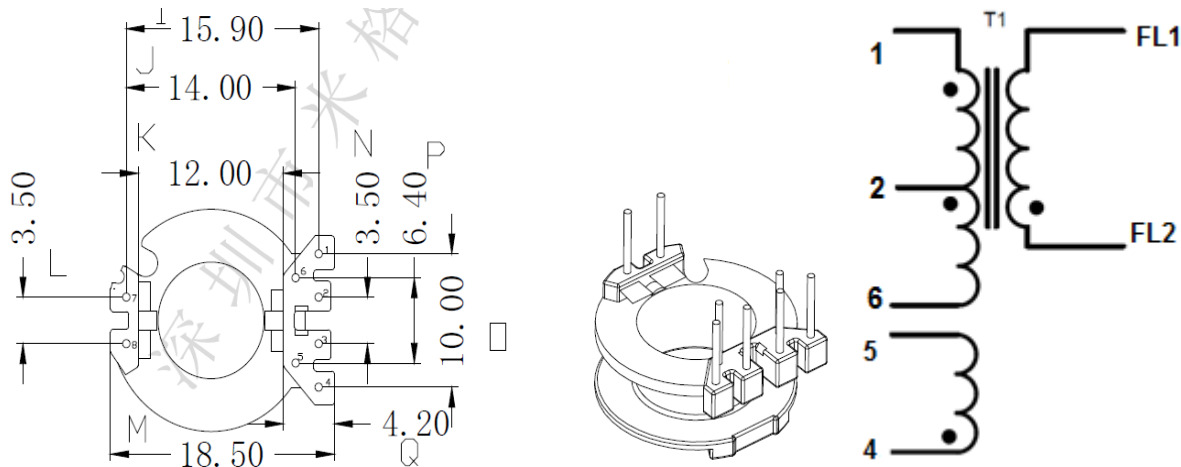

Figure 2: Bottom View

AP3785T (90V<sub>AC</sub> ~ 265V<sub>AC</sub> one outputs 15W Transformer Spec.)

1) Low profile RM8 Core & Bobbin: 6+6 pin    2) Electrical Diagram:



3) Transformer Parameters

1. Primary Inductance (Pin1-Pin6), all other windings are open  
L<sub>p</sub> = 0.70mH ±5% @1KHz

RM8(AE=64mm <sup>2</sup> )					
NO	NAME	TERMINAL NO.		WINDING	
		START	FINISH	WIRE	TURNS
1	Np1 (2/3)	2	1	0.25Φ*1	30
2	Na	5	4	0.23Φ*2	8
3	Ns	A	B	0.8Φ TIW *1	3
4	Shield	4	NC	0.23Φ*1	15
5	Np1 (1/3)	1	3	0.23Φ*1	15

<b>Primary Inductance</b>	Pin 2-1, all other windings open, measured at 1kHz, 0.4VRMS	<b>0.7mH, ±7%</b>
<b>Primary Leakage Inductance</b>	Pin 2-1, all other windings shorted, measured at 10kHz, 0.4VRMS	<b>30 uH (Max.)</b>

## Evaluation Board Schematic

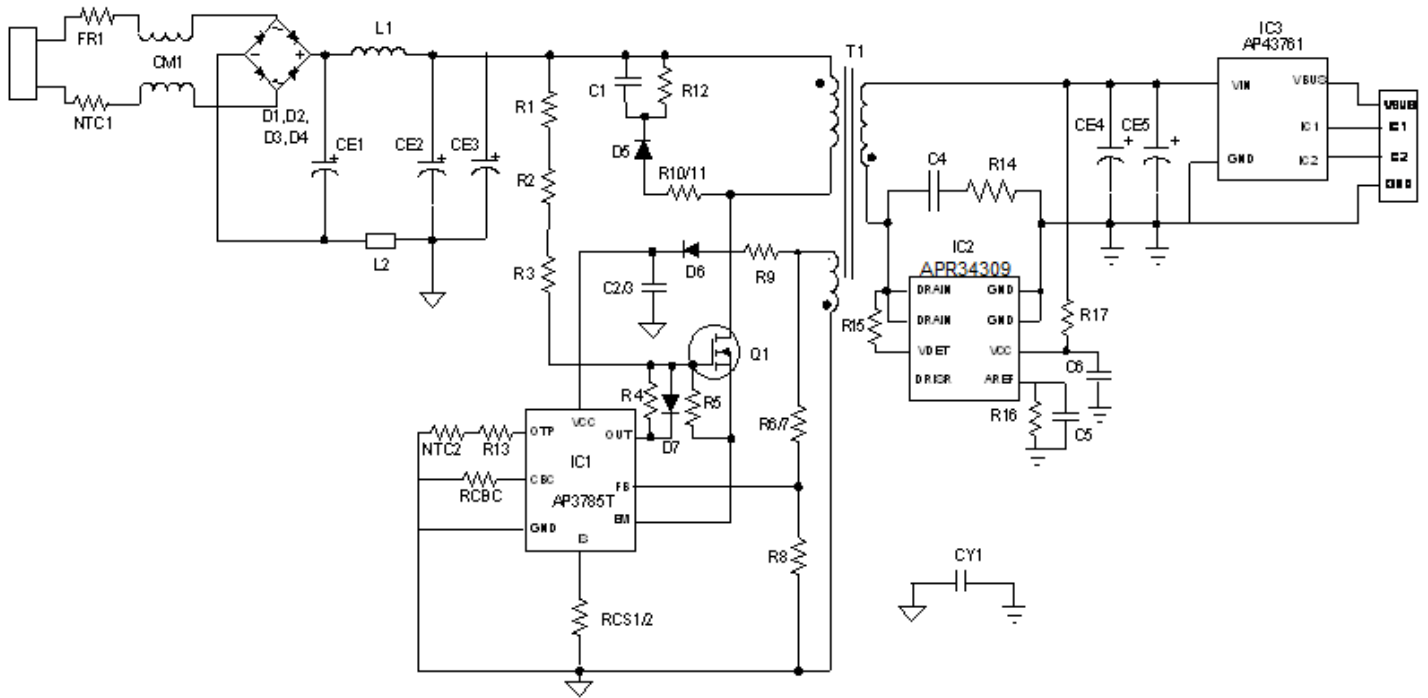

## Evaluation Board Layout

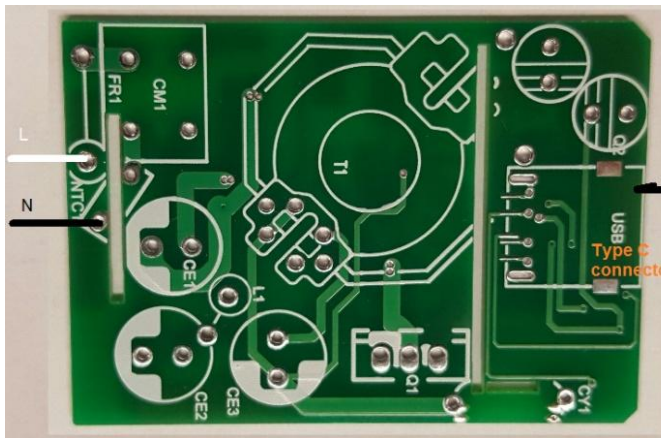

Figure4: PCB Board Layout Top View

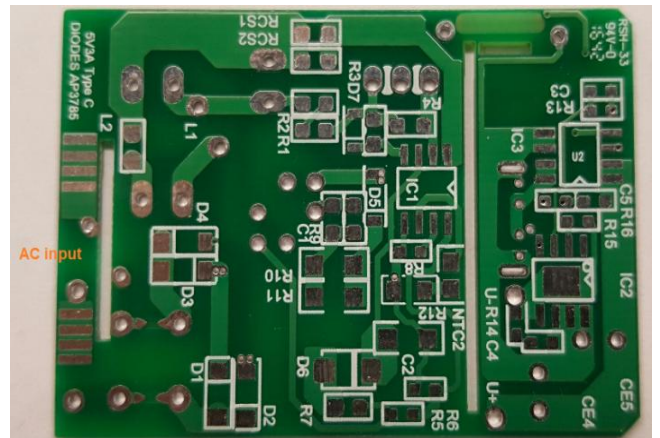

Figure5: PCB Board Layout Bottom View

## Quick Start Guide

1. The evaluation board is preset at 5V/3A from side of AC input L ~N and output with Type C connector
2. Ensure that the AC source is switched OFF or disconnected.
3. Connect the AC line wires of power supply to "L and N" on the Left side of the board.
4. Turn on the AC main switch.
5. Measure output at Type C connector 5V+ & 5V- to ensure the voltage is respectively.

Build of Material

AP3785T 5V-3A BOM 10-18-2016

Item	QTY per board	REF. DES.	Description	MFG or Supplier
1	3	CE1,2,3	10uf /400V 8 x 12mm	Wurth Electro
2	2	CE4,CE5	680uf /6.3V 6.3 x 9.0mm	Wurth Electro
3	1	C1	2,2nf/500V 0805 X7R 0805	Holy Stone
4	1	C2,	10uF/50V 1206 ceramic	Holy Stone
5	1	C4	1nf / 50V, 0603 X7R	Yageo
6	1	C3	2.2nf 16V 0603 X7R	Yageo
7	1	C6	100nf /16V 0603 X7R	Yageo
8	2	Rcs1, Rcs2	1.1 /1.2 ohm 0805	Yageo
9	1	Rcbc	36K 0603	Yageo
10	2	R1, R2	20M ohm 0805	Yageo
11	2	R3, R6	0 ohm 0805	Yageo
12	1	R4	150 ohm	Yageo
13	1	R5	5.1M ohm, 0805	Yageo
14	1	R7	33k ohm, 0603	Yageo
15	1	R8	7.5K ohm 0603	Yageo
16	1	R9	2.2 ohm 0603	Yageo
17	2	R10, R11	100 ohm 1206	Yageo
18	1	R12	180k 0805	Yageo
19	1		of f 0805	Yageo
20	3	R14,R15,R17	10 ohm 0603	Yageo
21	1	R13	36K 0603	Yageo
22	6	D1 ~ D6	S1MWF 1A/1KV SOT123F	Diodes
23	1	D7	1N4148	Diodes
24	1	FR1	Fuse 1A	Eq
25	1	NTC1	5D-5	Eq
26	1	NTC2	3.6k 0805	Yageo
27	1	L1	470uF EMI-chock	
28	1	L2	Bead	
29	1	CM1	EE8.3 20 mH pitch 5x7mm	
30	1	T1	RM8 6+6 pin Low profile	TDK
31	1	CY1	1000pf / 3KV	
32	1	IC1	AP3785T--	Diodes
33	1	IC2	APR34309C--	Diodes
34	1	IC3	AP43761--	Diodes
35	1	Q1	STT8N65	Diodes
36	1	UCB-Type C	Type C conector	

**Input & Output Characteristics**

**Input Standby Power**

<b>Input Voltage</b>	<b>115Vac/60Hz</b>	<b>230Vac/50Hz</b>	<b>Note</b>
<b>Pin (w)</b>	<b>4mW</b>	<b>7mW</b>	<b>At no loading</b>

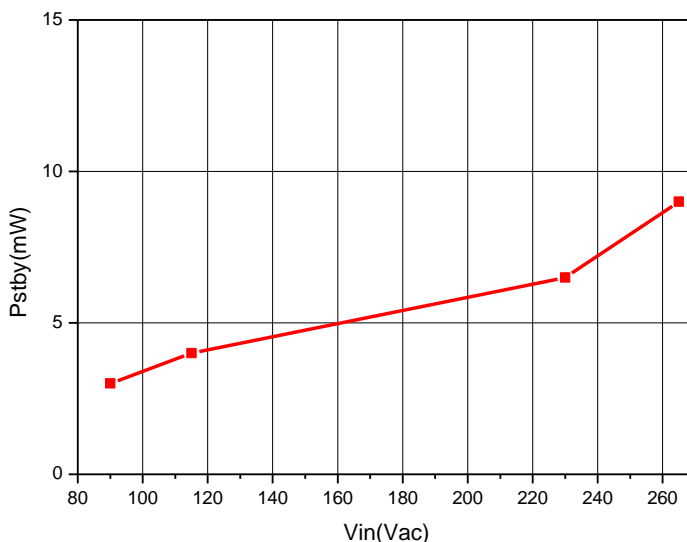

**Input power Efficiency at different loading**

	10%	25%	50%	75%	100%	AV
115V	85.49	87.25	86.48	85.91	85.34	85.24
230V	82.18	86.69	87.45	87.16	86.83	87.03

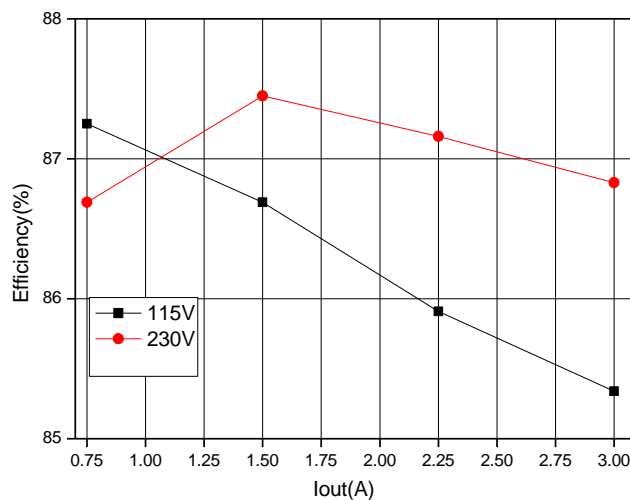

Average Efficiency@115V: 85.24%  
 @230V: 87.03%  
 Frequency: 57K@3A

**Test Condition: Tested at end of PCB board**

### Output I-V Curve:

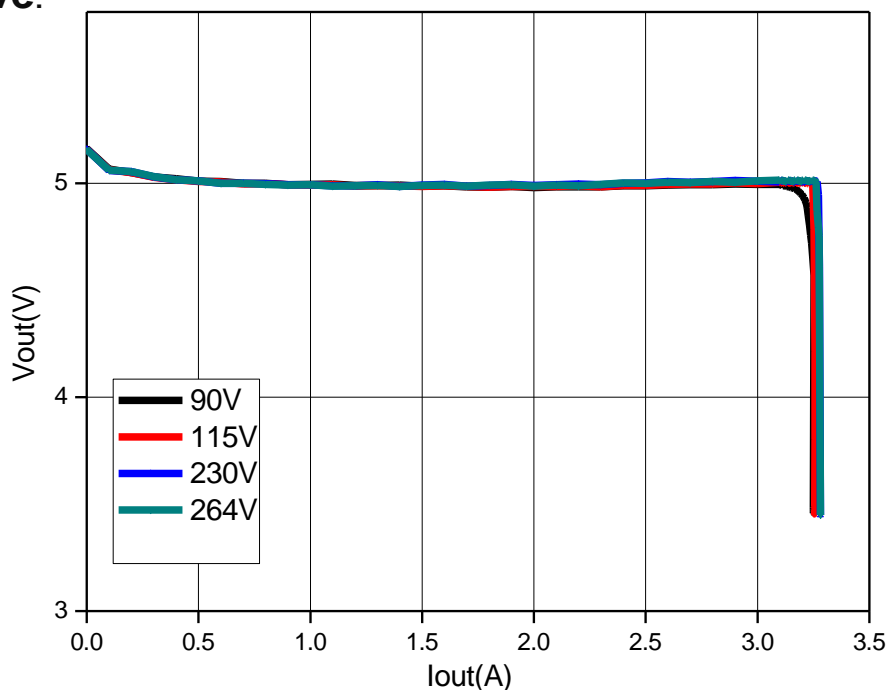

**Test Condition: Tested at end of PCB board**

### PSU Output Characteristics:

Line Regulation (at full loading condition):

AC input Voltage		90VAC/60Hz	115VAC/60Hz	230VAC/50Hz	265VAC/50Hz	Note
outputs	5.0 Vo	5.1V/3A	5.1V/3A	5.2V/3A	5.2V/3A	0.5%<

Load Regulation (at nominal line AC input voltage):

Loading conditions	5.0V =10%FL	5V= 100% load FL	Load Regulation Note
115VAC	5.358V/0.3A	5.14V/3.0A	4.24% < 5%
230VAC	5.334V/0.3A	5.14V/3.0A	3.77 %< 5%

Current setting with at different AC line

AC input	90VAC	115VAC	230VAC	264VAC	Note
I_max	2.67A	2.69A	2.73A	2.78A	

Note: All output voltages are measured at output PCB board Edge.



### Key Performance Waveforms:

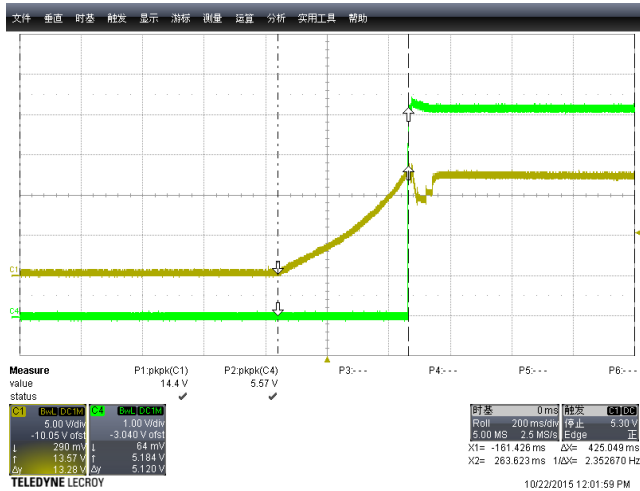

Fig:6 Vcc & Vout Start up time at 0A load at 90VAc

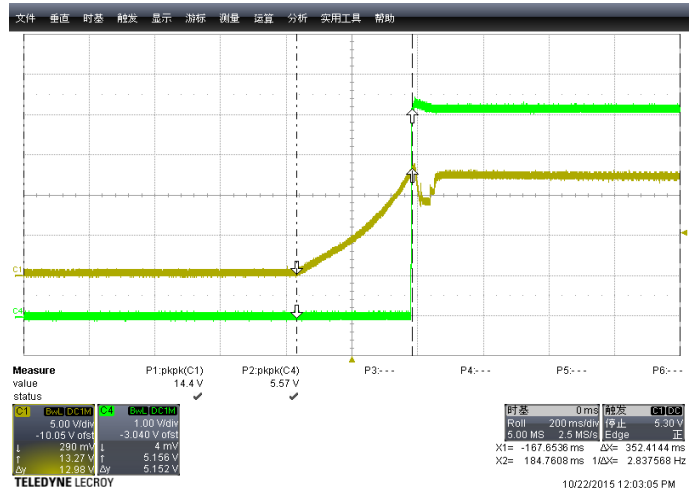

Fig:7 Vcc & Vout Start up time at 0A load at 265VAc

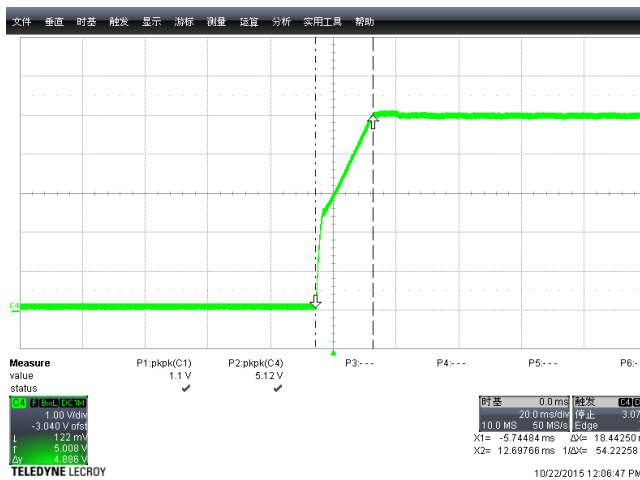

Fig:8 Vout Rising time at 0A load at 90VAc

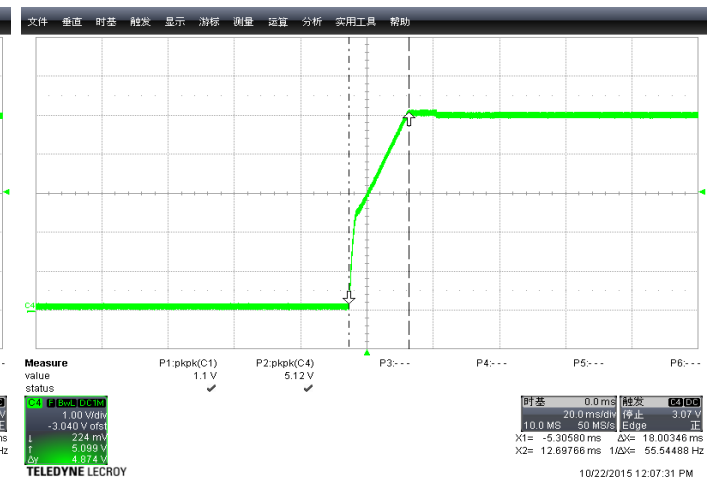

Fig:9 Vout Rising time at 0A load at 265VAc

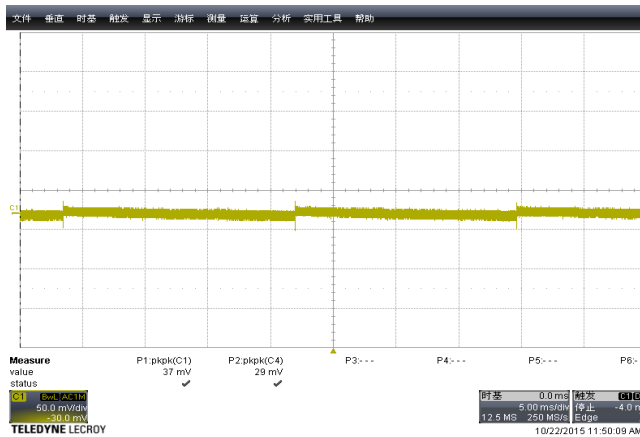

Fig:10 Vout Ripple 37mV at 0A at 90VAc

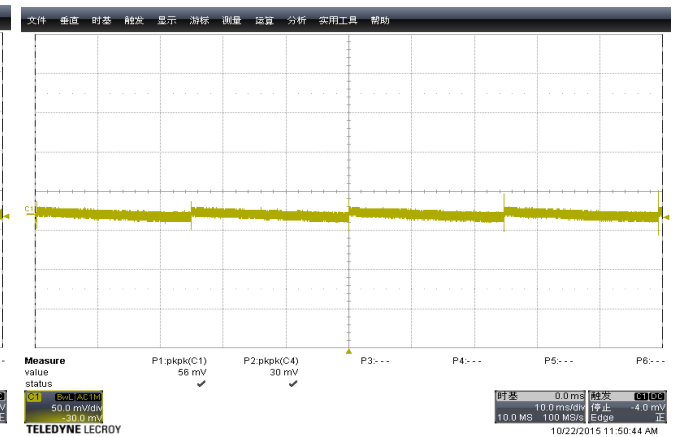

Fig:11 Vout Ripple 56mV at 0A at 266VAc

Output Performance Waveforms at 3A load

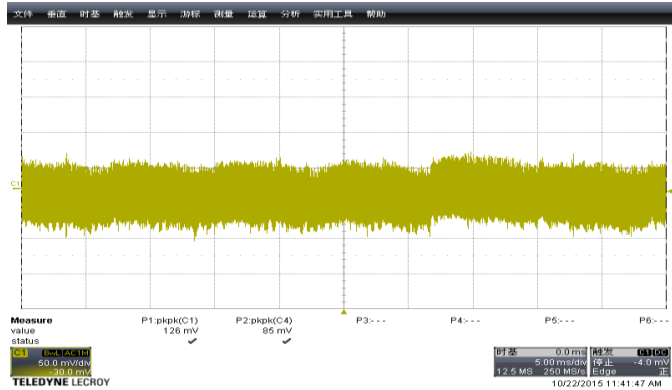

Fig:12 5Vout Ripple Voltage at 3A at 90Vac

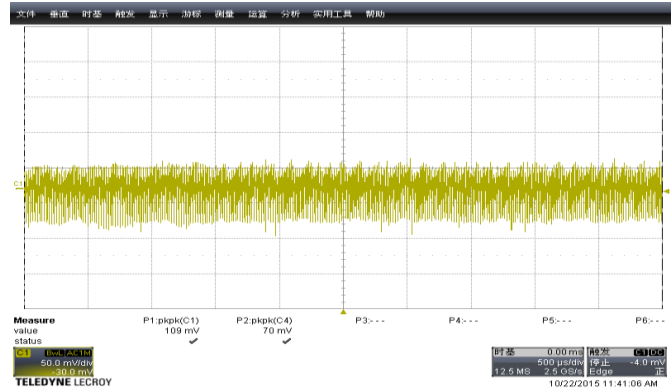

Fig:13 5Vout Ripple Voltage at 3A at 265Vac

Undershoot waveform during Dynamic loading from 0A to 3A

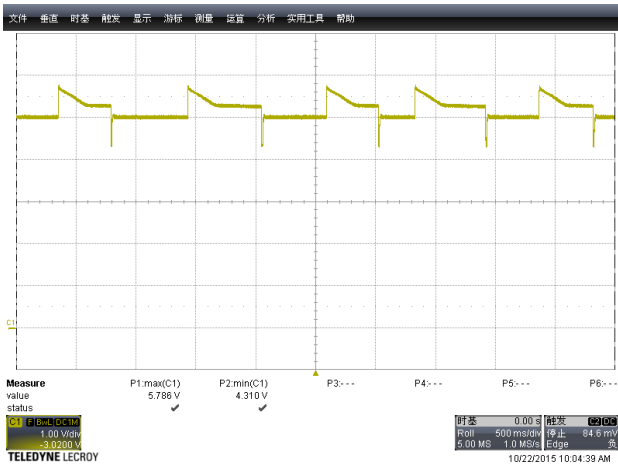

Fig:14 Vo\_min=4.42V & Vo\_max=5.78V at 90Vac.

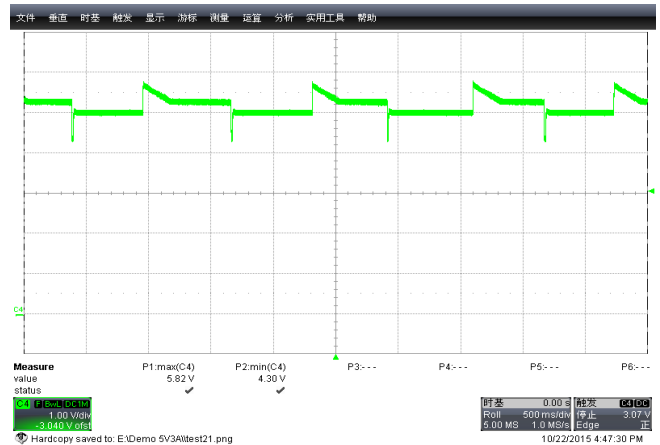

Fig:15 Vo\_min=4.41V & Vo\_max=5.82V at 265Vac

Switching Mosfet Vds voltage stress

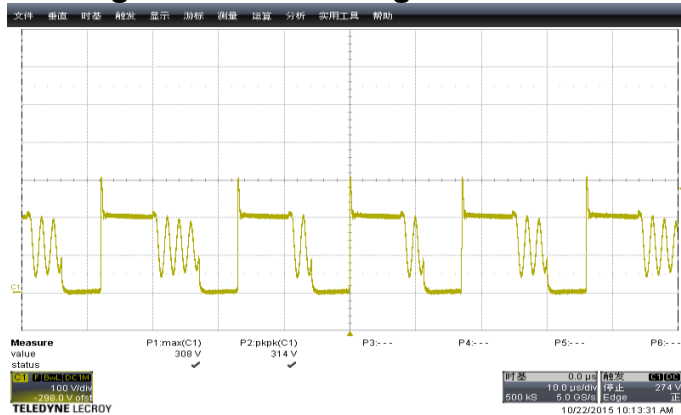

Fig:16 Vds = 308Vp-p at 3A at 90Vac

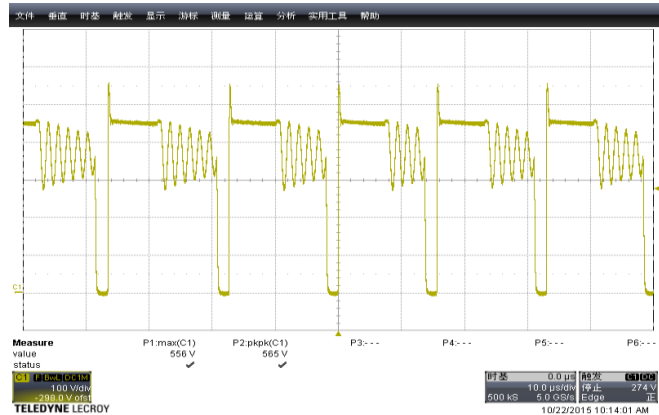

Fig:17 Vds = 565Vp-p at 3A at 265Vac



The Vds voltage stress for Secondary side Mosfet

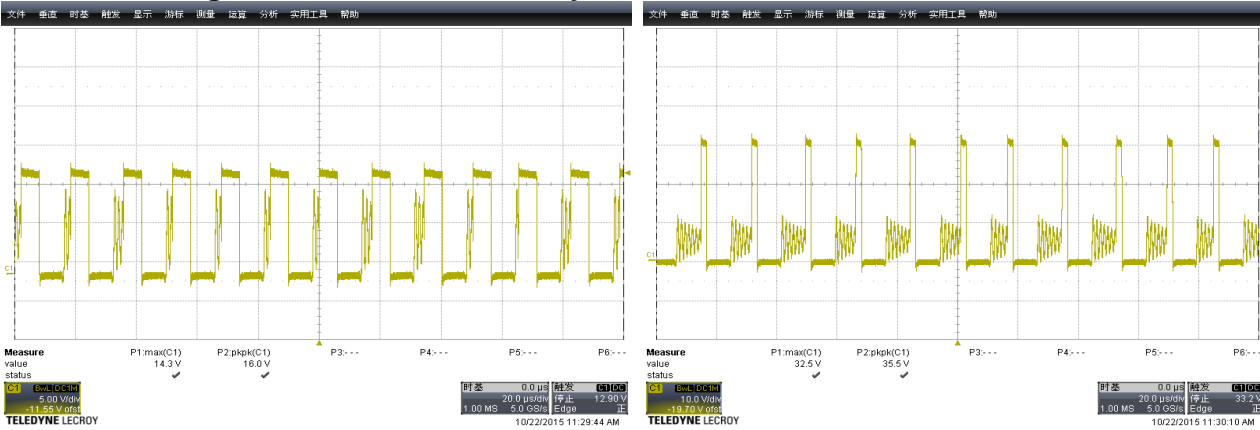

Fig:18 Vds = 18Vp-p at 3A at 90Vac

Fig:19 Vds = 35Vp-p at 3A at 265Vac

The voltage stress on AP43761\_P MOSFET

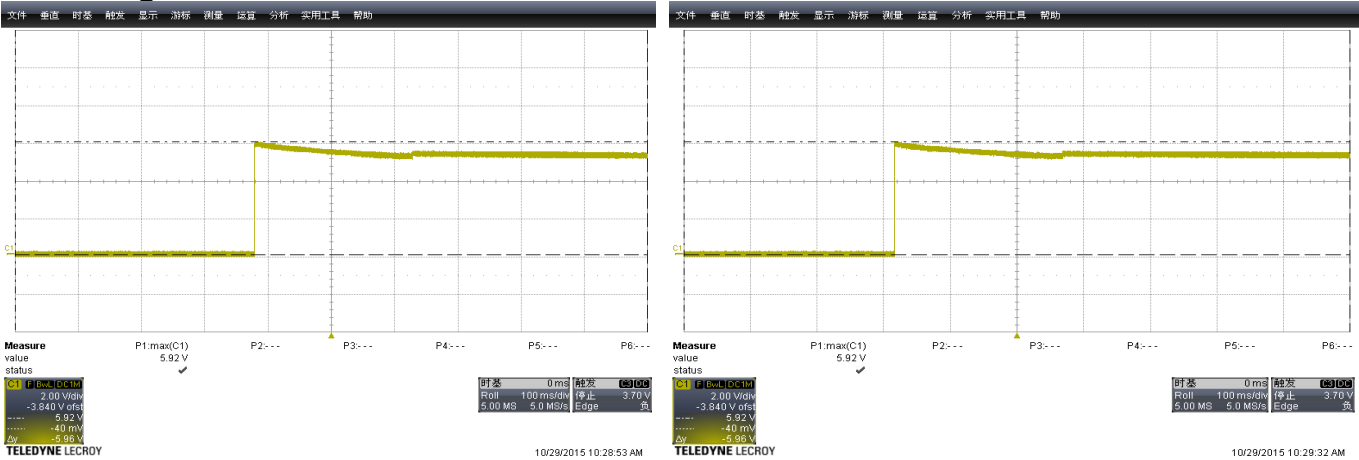

Fig:20 Vds = 5.92Vp-p at 3A at 90Vac

Fig:21 Vds = 5.91Vp-p at 3A at 265Vac

The Typc-C Function under different loading

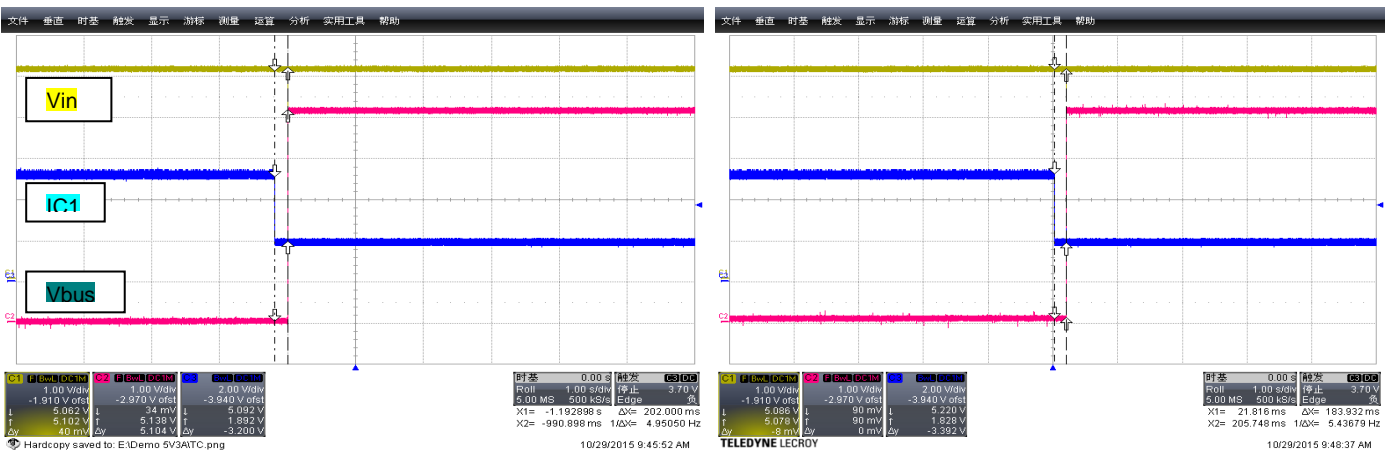

Fig:22 At 90Vac\_Rising time =202mS at 0A load

Fig:23 At 265Vac\_Rising time = 184mS at 0A load

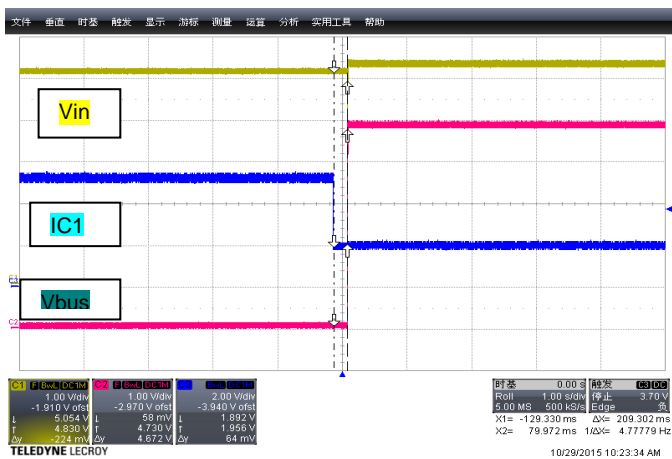

Fig:22 At 90Vac\_Rising time =209mS at 3A load

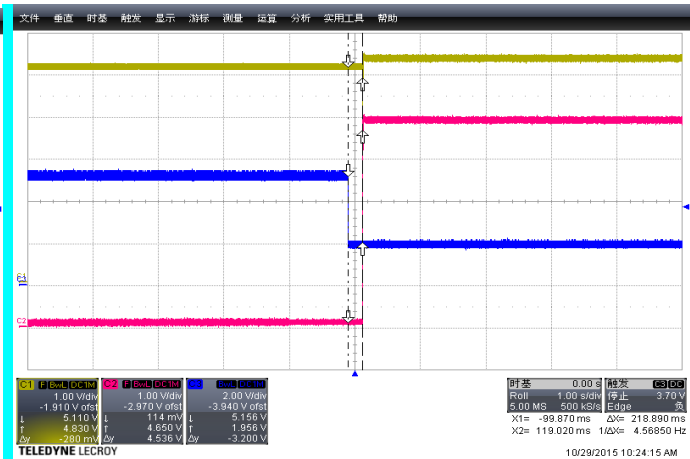

Fig:23 At 265Vac\_Rising time = 218mS at 3A load

**For AP3785T Thermal test operation & set up:**

Thermal Test data at room Temperature after running 1 hr

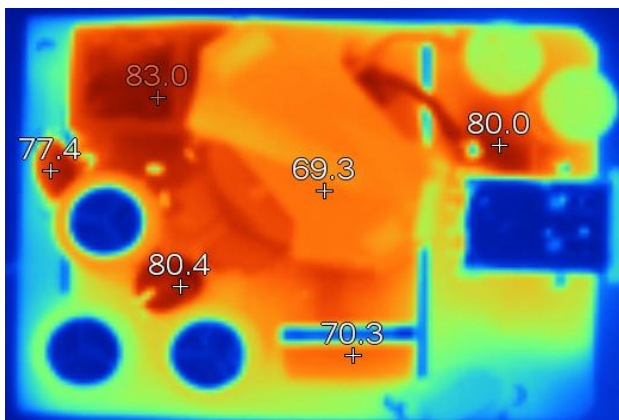

Fig:24 UP components side 90Vac FL

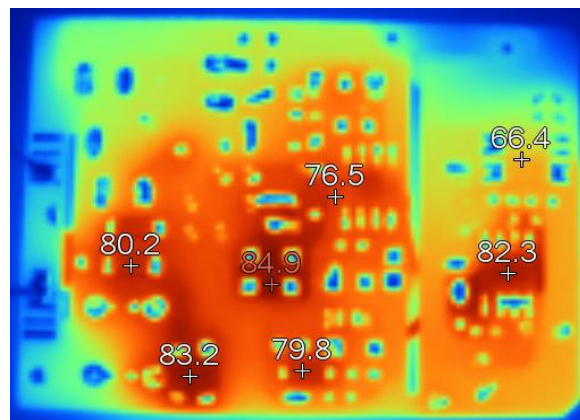

Fig:25 SMD side Vin=90V<sub>AC</sub>, FL Test time=1hour

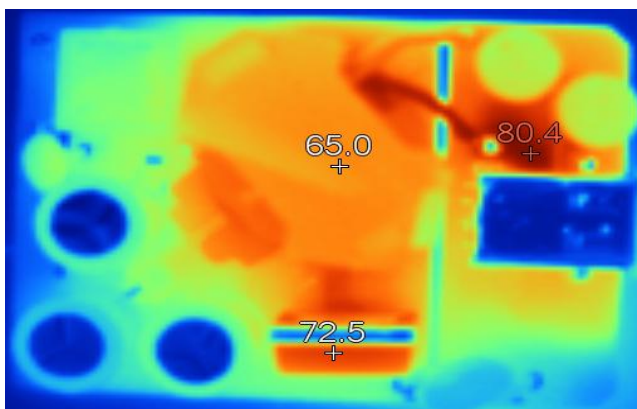

Fig: 26 Top components side at 265Vac at FL

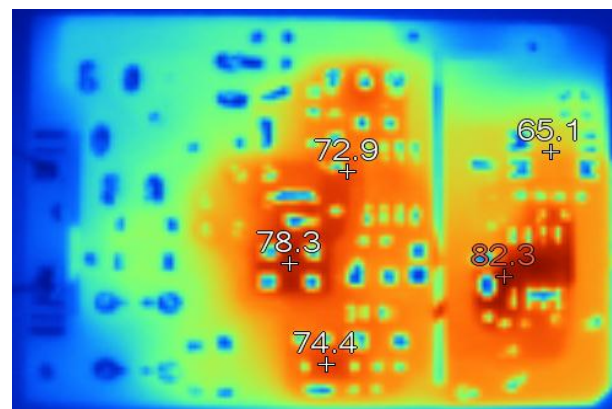
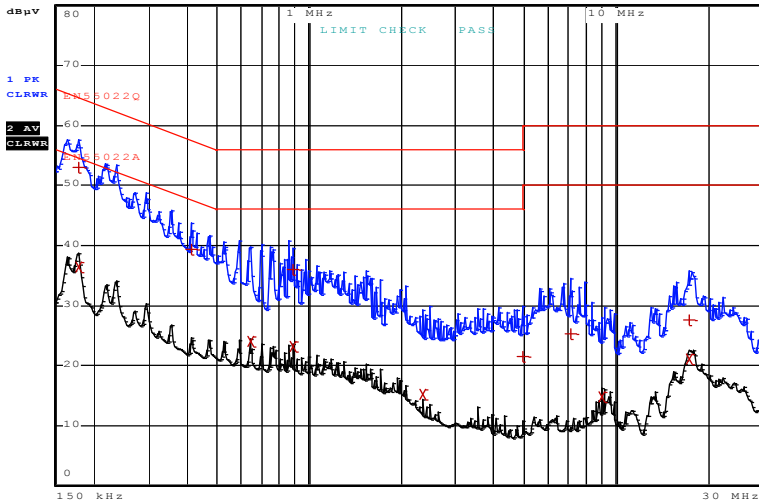

Fig:27 Vin=265V<sub>AC</sub>, at FL Testing time = 1.15 hour

## EMI test scan at AC\_Line



EDIT PEAK LIST (Final Measurement Results)			
TRACE	FREQUENCY	LEVEL dBµV	DELTA LIMIT dB
1 Quasi Peak	175.886796739 kHz	53.01	-11.65
2 Average	175.886796739 kHz	36.43	-18.23
1 Quasi Peak	409.779295157 kHz	39.42	-18.23
2 Average	641.227045055 kHz	24.06	-21.93
1 Quasi Peak	881.64914842 kHz	36.05	-19.94
2 Average	881.64914842 kHz	23.10	-22.90
2 Average	2.33770886123 MHz	15.13	-30.86
1 Quasi Peak	4.97983359306 MHz	21.57	-34.42
1 Quasi Peak	7.12499045243 MHz	25.24	-34.75
2 Average	8.95727450287 MHz	14.77	-35.22
1 Quasi Peak	17.2737469588 MHz	27.67	-32.32
2 Average	17.2737469588 MHz	21.19	-28.80

## EMI test scan at AC\_Neutral

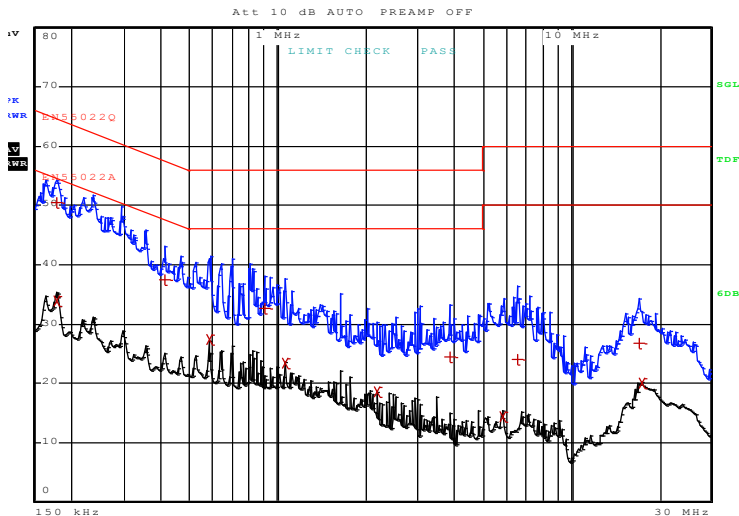

EDIT PEAK LIST (Final Measurement Results)			
TRACE	FREQUENCY	LEVEL dBµV	DELTA LIMIT dB
1 Quasi Peak	175.886796739 kHz	50.55	-14.12
2 Average	175.886796739 kHz	33.82	-20.85
1 Quasi Peak	409.779295157 kHz	37.51	-20.14
2 Average	580.494478884 kHz	27.43	-18.56
1 Quasi Peak	899.370296303 kHz	32.61	-23.38
2 Average	1.05458240332 MHz	23.41	-22.58
2 Average	2.1588349124 MHz	18.55	-27.44
1 Quasi Peak	3.84467038339 MHz	24.51	-31.48
2 Average	5.78143220445 MHz	14.38	-35.61
1 Quasi Peak	6.51466251798 MHz	24.14	-35.85
1 Quasi Peak	16.9333859021 MHz	26.82	-33.17
2 Average	17.2737469588 MHz	20.02	-29.97

Please see the recommend Application note for reference (Web page - [http://www.diodes.com/appnote\\_dnote.html](http://www.diodes.com/appnote_dnote.html))

- 1) For AP3125 operation & set up, please review the Application note:  
**Application note 1120 Green Mode PWM Controller**
- 2) For PSU PCB layout consideration, please review the App note:  
**AN1062 High Voltage Green Mode PWM Controller AP3105**
- 3) For the basic Flyback topology calculation, please review the App note:  
**AN1045 Design Guidelines for Off-line AC-DC Power Supply Using BCD. PWM Controller AP3103**

## IMPORTANT NOTICE

DIODES INCORPORATED MAKES NO WARRANTY OF ANY KIND, EXPRESS OR IMPLIED, WITH REGARDS TO THIS DOCUMENT, INCLUDING, BUT NOT LIMITED TO, THE IMPLIED WARRANTIES OF MERCHANTABILITY AND FITNESS FOR A PARTICULAR PURPOSE (AND THEIR EQUIVALENTS UNDER THE LAWS OF ANY JURISDICTION).

Diodes Incorporated and its subsidiaries reserve the right to make modifications, enhancements, improvements, corrections or other changes without further notice to this document and any product described herein. Diodes Incorporated does not assume any liability arising out of the application or use of this document or any product described herein; neither does Diodes Incorporated convey any license under its patent or trademark rights, nor the rights of others. Any Customer or user of this document or products described herein in such applications shall assume all risks of such use and will agree to hold Diodes Incorporated and all the companies whose products are represented on Diodes Incorporated website, harmless against all damages.

Diodes Incorporated does not warrant or accept any liability whatsoever in respect of any products purchased through unauthorized sales channel.

Should Customers purchase or use Diodes Incorporated products for any unintended or unauthorized application, Customers shall indemnify and hold Diodes Incorporated and its representatives harmless against all claims, damages, expenses, and attorney fees arising out of, directly or indirectly, any claim of personal injury or death associated with such unintended or unauthorized application.

Products described herein may be covered by one or more United States, international or foreign patents pending. Product names and markings noted herein may also be covered by one or more United States, international or foreign trademarks.

This document is written in English but may be translated into multiple languages for reference. Only the English version of this document is the final and determinative format released by Diodes Incorporated.

## LIFE SUPPORT

Diodes Incorporated products are specifically not authorized for use as critical components in life support devices or systems without the express written approval of the Chief Executive Officer of Diodes Incorporated. As used herein:

A. Life support devices or systems are devices or systems which:

1. are intended to implant into the body, or
2. support or sustain life and whose failure to perform when properly used in accordance with instructions for use provided in the labeling can be reasonably expected to result in significant injury to the user.

B. A critical component is any component in a life support device or system whose failure to perform can be reasonably expected to cause the failure of the life support device or to affect its safety or effectiveness.

Customers represent that they have all necessary expertise in the safety and regulatory ramifications of their life support devices or systems, and acknowledge and agree that they are solely responsible for all legal, regulatory and safety-related requirements concerning their products and any use of Diodes Incorporated products in such safety-critical, life support devices or systems, notwithstanding any devices- or systems-related information or support that may be provided by Diodes Incorporated. Further, Customers must fully indemnify Diodes Incorporated and its representatives against any damages arising out of the use of Diodes Incorporated products in such safety-critical, life support devices or systems.

Copyright © 2016, Diodes Incorporated

[www.diodes.com](http://www.diodes.com)