

Features

- Gain: 13.5 dB @ 6 GHz
- Output P1dB: 18 dBm @ 6 GHz
- Noise figure: 4.5 dB @ 6 GHz
- Single Bias Operation
- Adjustable Current
- Lead-Free 1.5 x 1.2 mm 6-lead TDFN Plastic Package
- Halogen-Free “Green” Mold Compound
- RoHS* Compliant

Description

The MAAM-011206 is a versatile, DC - 15 GHz, Darlington amplifier, with 13.5 dB typical gain and 18 dBm of output power. The input and output are fully matched to 50 Ω with typical return loss >10 dB. Third order linearity (OIP3) is typically 28 dBm and reverse isolation is >21 dB. Functional operation is achieved with a single bias voltage V_{DD} , from +3 V to +5 V.

An external resistor between V_{DD} and pin 6 enables single bias operation. No negative bias is necessary. See DC Bias Operation table for external resistor value selection.

The MAAM-011206 is housed in a leadless 1.5 x 1.2 mm plastic SMT package compatible with standard pick and place assembly equipment. It is fabricated using a GaAs process which features full passivation for increased performance and reliability.

The device is well suited to diverse applications such as LO drivers, gain blocks and RF driver stages.

Ordering Information^{1,2}

Part Number	Package
MAAM-011206-TR1000	1000 Piece Reel
MAAM-011206-TR3000	3000 Piece Reel
MAAM-011206-SMB	Sample Board

1. Reference Application Note M513 for reel size information.
2. All sample boards include 3 loose parts.

Functional Schematic

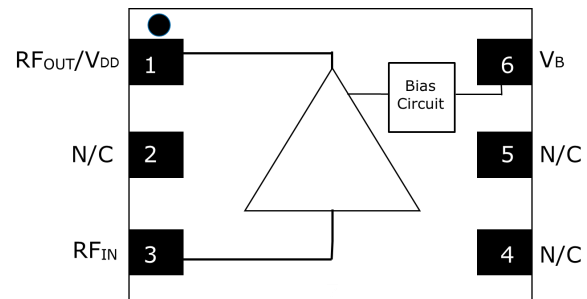

Pin Configuration^{3,4}

Pin No.	Pin Name	Description
1	RF _{OUT} / V _{DD}	RF Output / Drain Bias
2	N/C	No Connection ³
3	RF _{IN}	RF Input
4	N/C	No Connection ³
5	N/C	No Connection ³
6	V _B	Bias Adjust

3. MACOM recommends connecting unused package pins to ground.
4. The exposed pad centered on the package bottom must be connected to RF, DC and thermal ground.

* Restrictions on Hazardous Substances, European Union Directive 2011/65/EU.

Broadband Darlington Amplifier DC-15 GHz

Rev. V1

Electrical Specifications: $T_A = 25^\circ\text{C}$, $V_{DD} = +5\text{ V}$, $V_B^5 = 1.5\text{ V}$, $Z_0 = 50\ \Omega$

Parameter	Test Conditions	Units	Min.	Typ.	Max.
Gain	1 GHz 6 GHz 12 GHz 15 GHz	dB	— 11.5 9.5 —	15.0 13.5 11.0 10.0	—
Isolation	0.1 - 15 GHz	dB	—	22	—
Input Return Loss	0.1 - 15 GHz	dB	—	15	—
Output Return Loss	0.1 - 15 GHz	dB	—	15	—
Noise Figure	1 GHz 6 GHz 12 GHz 15 GHz	dB	—	4.0 4.5 6.0 7.0	—
Output P_{SAT}	1 GHz 6 GHz 12 GHz 15 GHz	dBm	—	19.0 20.0 18.0 16.0	—
Output Power	$P_{IN} = 6.5\text{ dBm}$ 1 GHz 6 GHz 12 GHz 15 GHz	dBm	— 16.0 14.0 —	20.0 18.0 16.0 15.5	—
Output IP3	$P_{IN} = -5\text{ dBm/tone}$, 1 MHz tone spacing 1 GHz 6 GHz 12 GHz 15 GHz	dBm	—	28.0 28.0 27.5 27.0	—
Bias Current	—	mA	—	72	—

5. For single voltage operation, refer to typical R_B values and biasing information on pages 3 and 4.

DC Bias Operation

Bias Adjust Using V_B

Pin 6 can be connected to a separate voltage source to achieve the desired I_{DD} , not to exceed 120 mA. The amplifier will be powered down by applying a V_B of 0.2 V or less.

Single Bias Operation

Connecting V_{DD} to pin 6 with an external resistor R_B enables single bias operation of the amplifier; see page 4 application information. The value of external resistor R_B sets the desired current I_{DD} . The following table shows approximate performance at 6 GHz with different external resistor values.

V_{DD} (V)	R_B (Ω)	I_{DD} (mA)	Gain (dB)	P_{1dB} (dBm)	RL (I/O) (dB)
5	20000	26	11	—	13
5	11000	34	12	17	15
5	6800	47	13	17	17
5	4800	62	13	18	17
5	4000	72	13	19	18

The following table shows drain current (I_{DD}) versus external resistor (R_B) values for V_{DD} voltages of 5 V & 3.3 V:

$V_{DD} = 3.3\text{ V}$		$V_{DD} = 5\text{ V}$	
R_B (Ω)	I_{DD} (mA)	R_B (Ω)	I_{DD} (mA)
8000	14	30000	23
5000	17	20000	26
3200	24	11000	34
2500	32	8500	40
2200	37	6800	47
1900	45	5500	55
1600	55	4800	62
1500	59	4500	65
1400	64	4000	72
1300	70	—	—

Absolute Maximum Ratings^{6,7}

Parameter	Absolute Maximum
Input Power	15 dBm
Operating Voltage	7 V
Junction Temperature ^{8,9}	+150°C
Operating Temperature	-40°C to +85°C
Storage Temperature	-65°C to +150°C

- Exceeding any one or combination of these limits may cause permanent damage to this device.
- MACOM does not recommend sustained operation near these survivability limits.
- Operating at nominal conditions with $T_J \leq +150^\circ\text{C}$ will ensure $\text{MTTF} > 1 \times 10^6$ hours.
- Junction Temperature (T_J) = $T_C + \Theta_{JC} * (V * I)$
Typical thermal resistance (Θ_{JC}) = 90°C/W.
 - For $T_C = +25^\circ\text{C}$,
 $T_J = 57^\circ\text{C}$ @ 5 V, 72 mA
 - For $T_C = +85^\circ\text{C}$,
 $T_J = 121^\circ\text{C}$ @ 5 V, 80 mA

Recommended PCB Layout

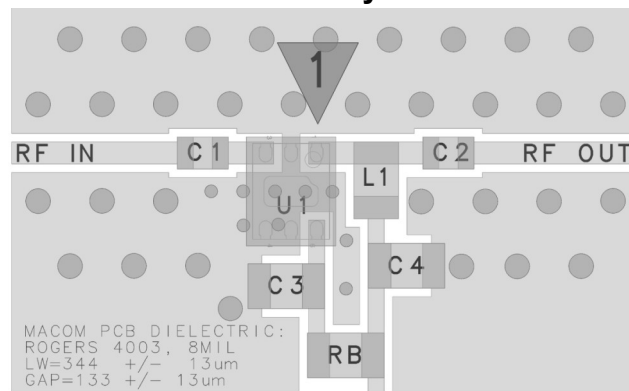

VDD

Parts List

Des	Value	Size	Part Number	Purpose
C1 C2	100 pF	0201	Murata GRM0335C1E101	DC Block
C3 C4	1 μF	0402	Taiyo Yuden LMK105BJ105	DC Bypass
R _B	See bias chart	0402	Various	DC bias
L1	470 Ω @ 100 MHz	0402	Murata BLM15GG471	Choke
U1	—	1.5 x 1.2 mm	MACOM MAAM-011206	Gain Block

Handling Procedures

Please observe the following precautions to avoid damage:

Static Sensitivity

These electronic devices are sensitive to electrostatic discharge (ESD) and can be damaged by static electricity. Proper ESD control techniques should be used when handling these devices.

Application Schematic

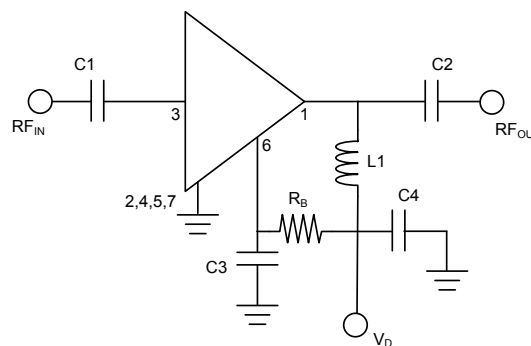

Grounding

It is recommended that the total ground (common mode) inductance not exceed 0.03 nH (30 pH). This is equivalent to placing at least four 8 mil (200 μm) diameter vias under the device, assuming an 8 mil (200 μm) thick RF layer to ground.

Broadband Darlington Amplifier DC-15 GHz

Rev. V1

Typical Performance Curves: $T_A = 25^\circ\text{C}$, $V_{DD} = +5\text{ V}$, $R_B = 4\text{ k}\Omega$, $Z_O = 50\ \Omega$

Gain

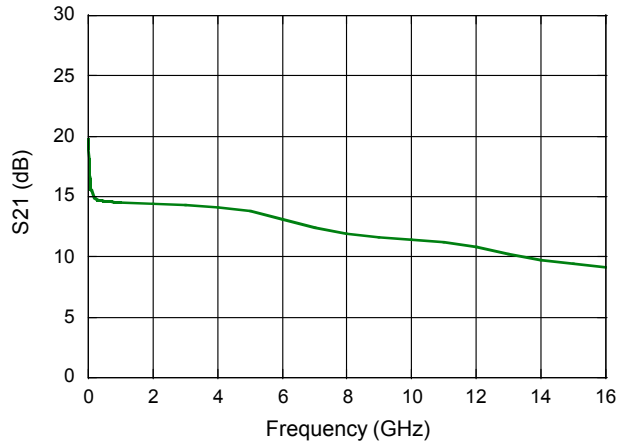

Return Loss

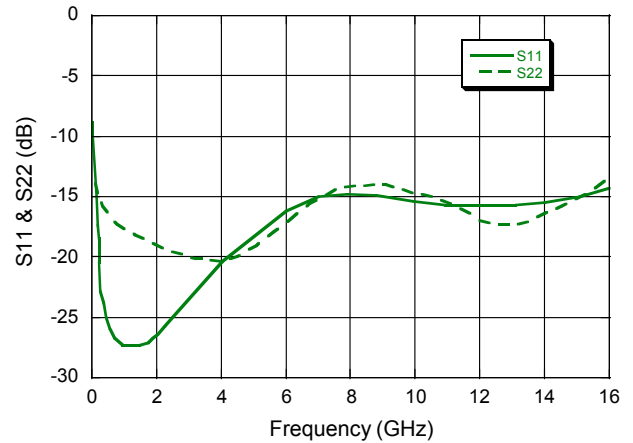

P1dB

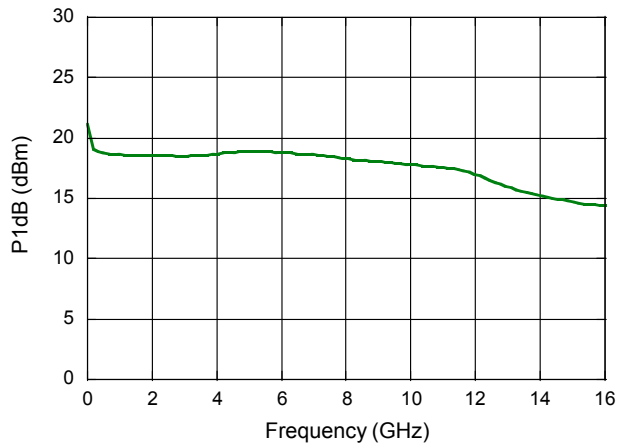

PsAT

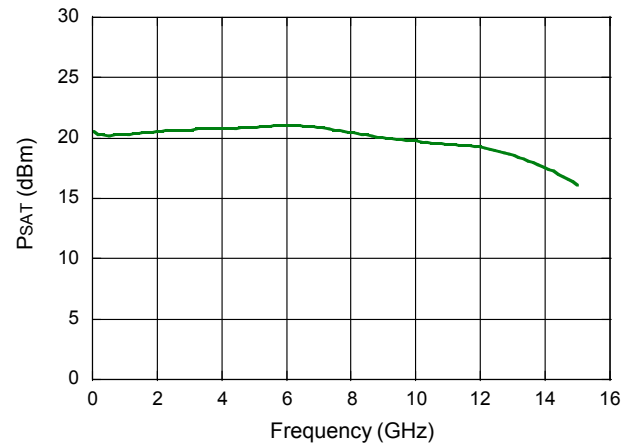

OIP3

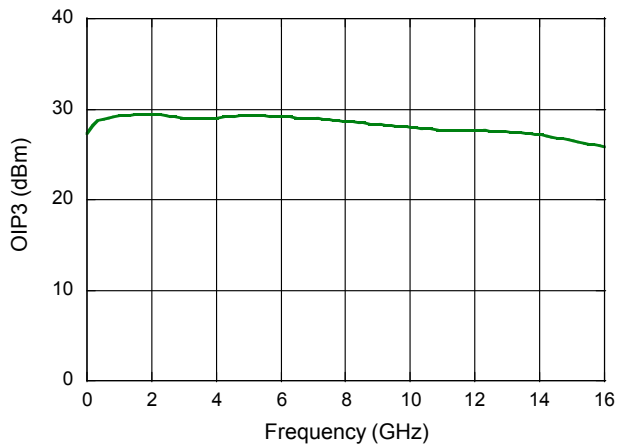

Noise Figure

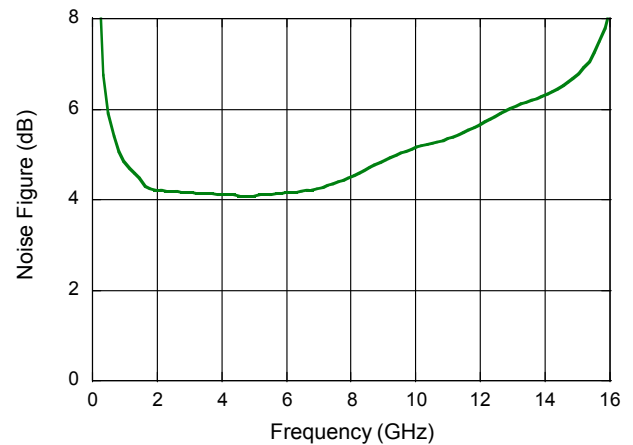

Broadband Darlington Amplifier DC-15 GHz

Rev. V1

Typical Performance Curves: $T_A = 25^\circ\text{C}$, $V_{DD} = +5\text{ V}$, $R_B = 4\text{ k}\Omega$, $Z_O = 50\ \Omega$

Gain vs. Frequency over Temperature

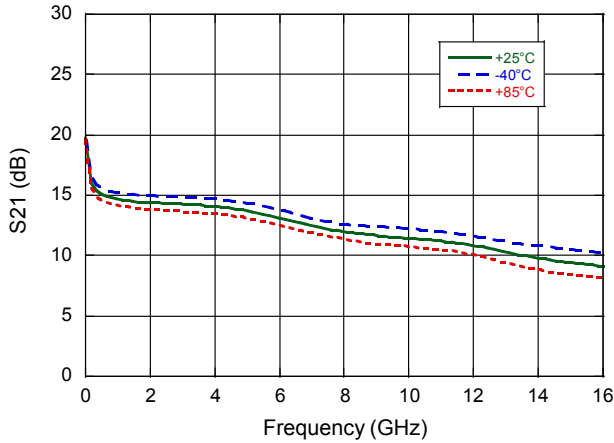

Gain vs. Frequency over Current

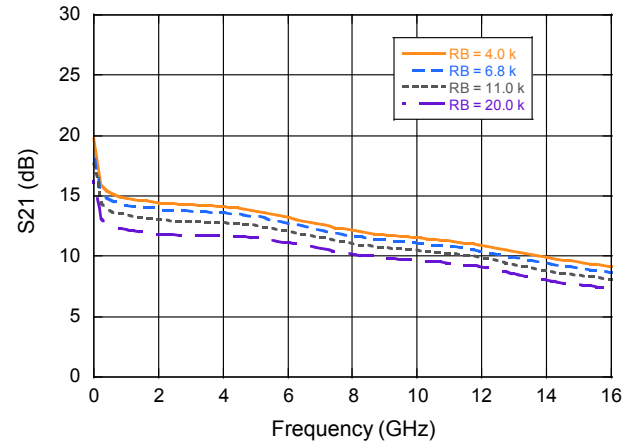

P1dB vs. Frequency over Temperature

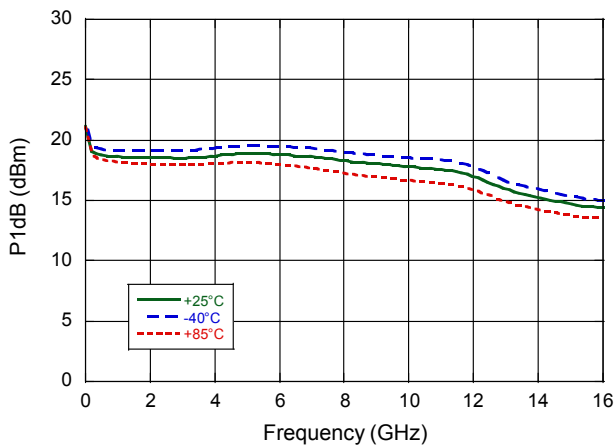

P1dB vs. Frequency over Current

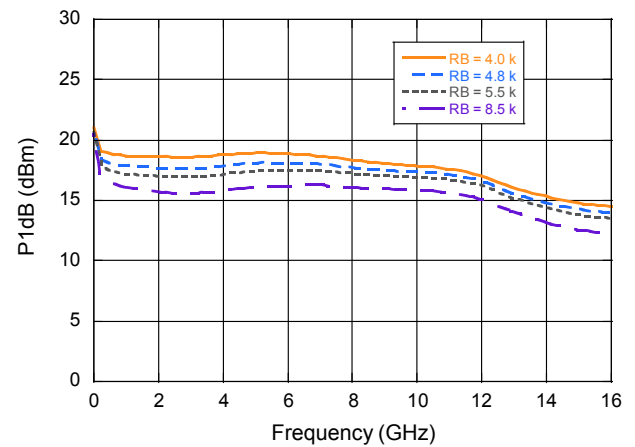

OIP3 vs. Frequency over Temperature

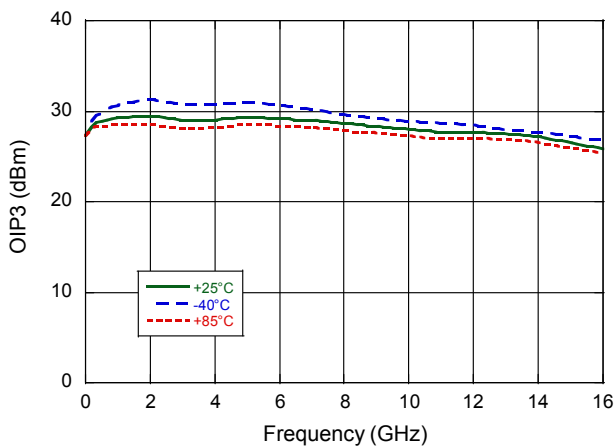

Current vs. R_B (Bias Resistance)

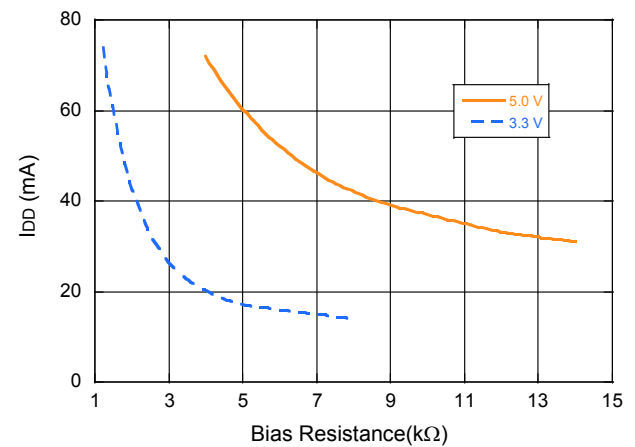

Sample PCB

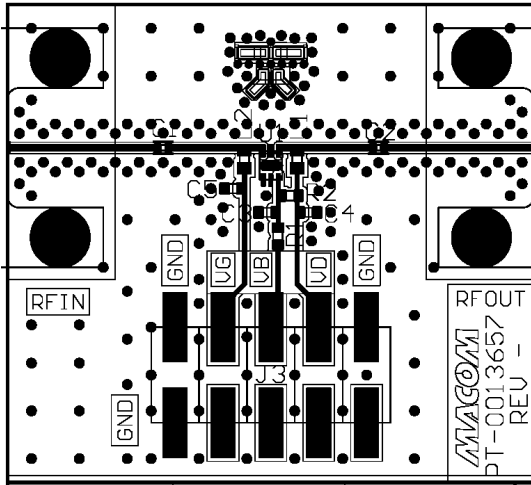

Sample PCB Layout

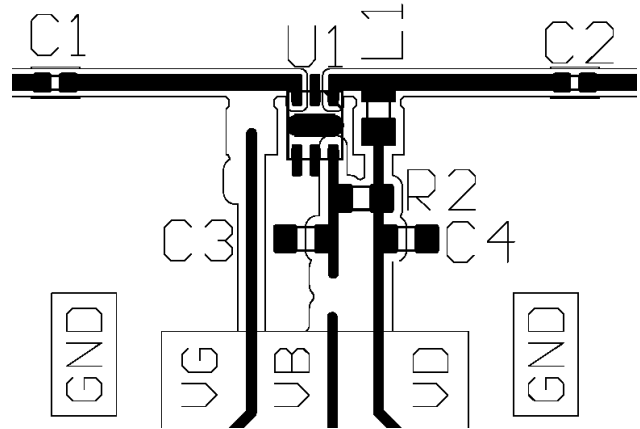

Sample PCB Schematic

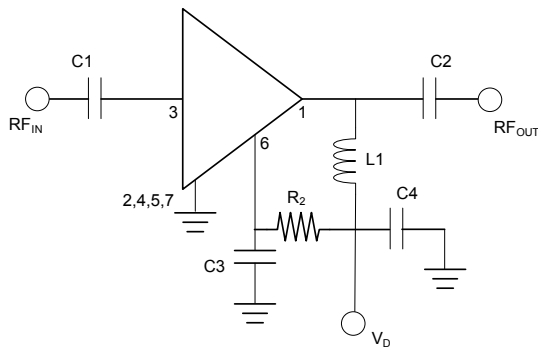

Sample PCB Parts List

Des	Value	Size	Part Number	Purpose
C1	100 pF	0201	Murata GRM0335C1E101	DC Block
C2	100 pF	0201	Murata GRM0335C1E101	DC Block
C3	1 μF	0402	Taiyo Yuden LMK105BJ105	DC Bypass
C4	1 μF	0402	Taiyo Yuden LMK105BJ105	DC Bypass
R2	See bias chart	0402	Various	DC bias
L1	470 Ω @ 100 MHz	0402	Murata BLM15GG471	Choke
U1	—	1.5 x 1.2 mm	MACOM MAAM-011206	Gain Block

Performance Data: Typical performance of sample PCB with $V_{DD} = 5\text{ V}$ and $R_2 = 4\text{ k}\Omega$

Gain

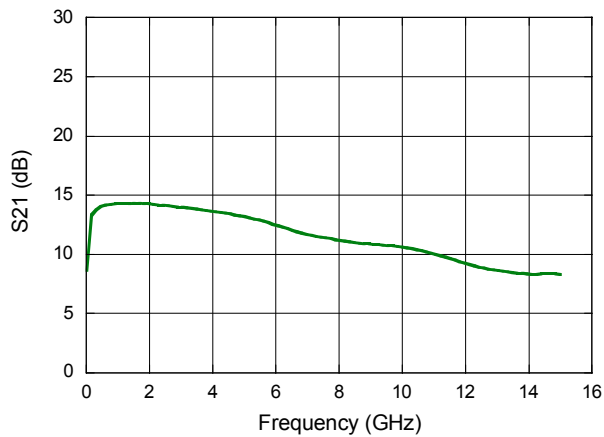

Return Loss

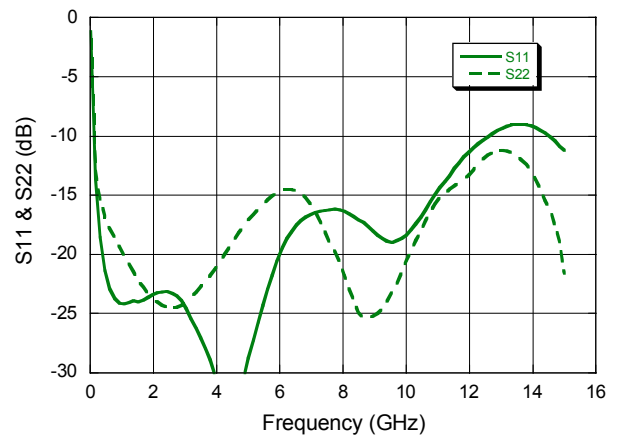

Lead-Free 1.5 x 1.2 mm 6-Lead

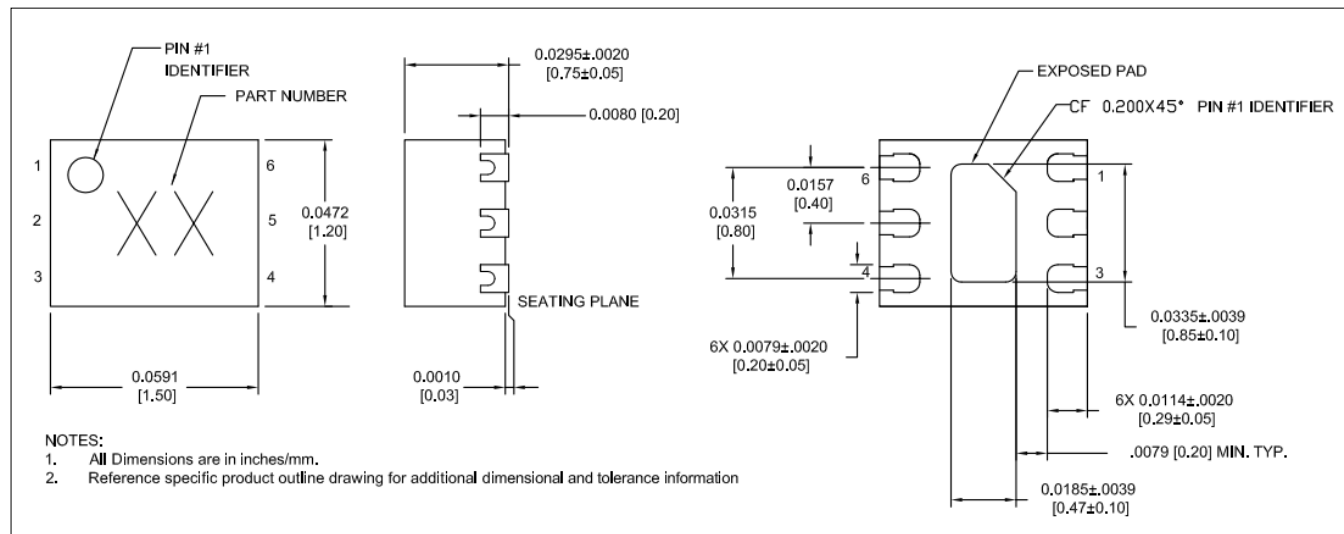

† Reference Application Note S2083 for lead-free solder reflow recommendations.
Plating is NiPdAuAg.

MACOM Technology Solutions Inc. All rights reserved.

Information in this document is provided in connection with MACOM Technology Solutions Inc ("MACOM") products. These materials are provided by MACOM as a service to its customers and may be used for informational purposes only. Except as provided in MACOM's Terms and Conditions of Sale for such products or in any separate agreement related to this document, MACOM assumes no liability whatsoever. MACOM assumes no responsibility for errors or omissions in these materials. MACOM may make changes to specifications and product descriptions at any time, without notice. MACOM makes no commitment to update the information and shall have no responsibility whatsoever for conflicts or incompatibilities arising from future changes to its specifications and product descriptions. No license, express or implied, by estoppel or otherwise, to any intellectual property rights is granted by this document.

THESE MATERIALS ARE PROVIDED "AS IS" WITHOUT WARRANTY OF ANY KIND, EITHER EXPRESS OR IMPLIED, RELATING TO SALE AND/OR USE OF MACOM PRODUCTS INCLUDING LIABILITY OR WARRANTIES RELATING TO FITNESS FOR A PARTICULAR PURPOSE, CONSEQUENTIAL OR INCIDENTAL DAMAGES, MERCHANTABILITY, OR INFRINGEMENT OF ANY PATENT, COPYRIGHT OR OTHER INTELLECTUAL PROPERTY RIGHT. MACOM FURTHER DOES NOT WARRANT THE ACCURACY OR COMPLETENESS OF THE INFORMATION, TEXT, GRAPHICS OR OTHER ITEMS CONTAINED WITHIN THESE MATERIALS. MACOM SHALL NOT BE LIABLE FOR ANY SPECIAL, INDIRECT, INCIDENTAL, OR CONSEQUENTIAL DAMAGES, INCLUDING WITHOUT LIMITATION, LOST REVENUES OR LOST PROFITS, WHICH MAY RESULT FROM THE USE OF THESE MATERIALS.

MACOM products are not intended for use in medical, lifesaving or life sustaining applications. MACOM customers using or selling MACOM products for use in such applications do so at their own risk and agree to fully indemnify MACOM for any damages resulting from such improper use or sale.