

## Voltage Variable Attenuator 5 - 45 GHz

Rev. V1

### Features

- 5 - 45 GHz Frequency Range
- 1.5 dB Insertion Loss @ 20 GHz
- >30 dB Attenuation Range
- High Linearity, 30 dBm IIP3
- Lead-Free 3 mm, 16-Lead QFN Package
- RoHS\* Compliant

### Description

The MAAV-011013 is a voltage variable attenuator with analog control and greater than 30 dB of attenuation. Excellent linearity is maintained over the full attenuation range. The attenuation level is set by two control voltages of 0 to -2 V. This device is assembled in a lead free 3 mm 16 lead PQFN plastic package.

Applications include transceivers for cellular infrastructure.

### Ordering Information<sup>1,2</sup>

Part Number	Package
MAAV-011013-TR0500	500 Part Reel
MAAV-011013-TR1000	1000 Part Reel
MAAV-011013-001SMB	Sample Board

1. Reference Application Note M513 for reel size information.
2. All sample boards include 5 loose parts.

### Functional Block Diagram

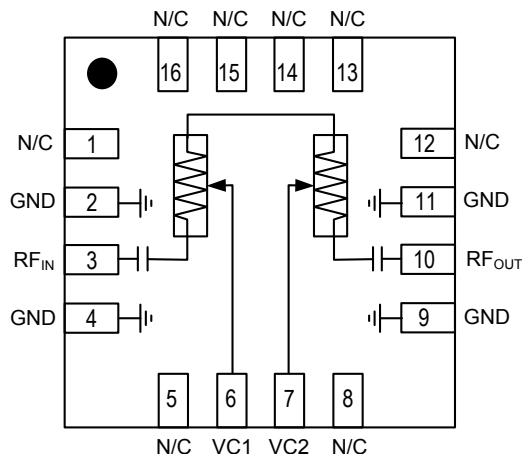

### Pin Configuration<sup>3,4</sup>

Pin No.	Function
1	No Connection
2	Ground
3	RF Input
4	Ground
5	No Connection
6	V <sub>C1</sub>
7	V <sub>C2</sub>
8	No Connection
9	Ground
10	RF Output
11	Ground
12 - 16	No Connection

3. It is recommended to connect unused pins to ground.
4. The exposed pad centered on the package bottom must be connected to RF, DC and thermal ground.

\* Restrictions on Hazardous Substances, European Union Directive 2011/65/EU.

## Voltage Variable Attenuator 5 - 45 GHz

Rev. V1

Electrical Specifications:  $T_A = +25^\circ\text{C}$ ,  $Z_0 = 50 \Omega$ ,  $P_{IN} = -10 \text{ dBm}$

Parameter	Test Conditions	Units	Min.	Typ.	Max.
Insertion Loss ( $V_{C1}$ and $V_{C2} = -2 \text{ V}$ )	5.9 - 15.5 GHz	dB	—	1.5	4.0
	17.6 - 20 GHz			1.5	4.0
	20 - 30 GHz			2.5	6.0
	30 - 34 GHz			2.5	6.5
	37 - 40 GHz			3.0	7.0
Attenuation ( $V_{C1}$ and $V_{C2} = 0 \text{ V}$ ) <sup>5</sup>	5.9 - 8.5 GHz	dB	22.5	25.0	—
	10 - 11.7 GHz		27.5	32.0	
	12.75-15.35 GHz		29.5	35.0	
	17.6 - 20 GHz		31.0	35.0	
	20 - 30 GHz		33.5	39.0	
	30 - 34 GHz		31.0	37.0	
	37 - 40 GHz		30.0	36.0	
Input P1dB <sup>6</sup>	5 - 25 GHz	dBm	24	25	—
	25 - 40 GHz		20	22	
IIP3 (any attenuation)	$P_{IN} = 12 \text{ dBm/tone @ } 5.0 - 15.0 \text{ GHz}$ $P_{IN} = 12 \text{ dBm/tone @ } 15.0 - 26.5 \text{ GHz}$ $P_{IN} = 12 \text{ dBm/tone @ } 26.5 - 40.0 \text{ GHz}$	dBm	29.0 27.5 27.0	31.0 30.0 31.0	—
IIP3 ( $V_{C1}=V_{C2}=-2 \text{ V}$ )	$P_{IN} = 12 \text{ dBm/tone @ } 5 - 40 \text{ GHz}$	dBm	—	42	—
Input Return Loss (any attenuation)	—	dB	—	10	—
Output Return Loss (any attenuation)	—	dB	—	10	—

5. To increase attenuation from minimum attenuation state ( $V_{C1} = -2 \text{ V}$  and  $V_{C2} = -2 \text{ V}$ ) to max attenuation state ( $V_{C1} = 0 \text{ V}$  and  $V_{C2} = 0 \text{ V}$ ),  $V_{C1}$  increases to full range prior to adjusting  $V_{C2}$ .

6. Guaranteed on MACOM Sample Board only

### Absolute Maximum Ratings<sup>7,8</sup>

Parameter	Absolute Maximum
Input Power	30 dBm
Voltage (RF pins)	30 V
Voltage (control pins)	+1 V to -6 V
Storage Temperature	-55°C to +150°C
Case Temperature	-40°C to +85°C

- Exceeding any one or combination of these limits may cause permanent damage to this device.
- MACOM does not recommend sustained operation near these survivability limits.

### Handling Procedures

The following precautions should be observed to avoid damage:

### Static Sensitivity

Gallium Arsenide Integrated Circuits are sensitive to electrostatic discharge (ESD) and can be damaged by static electricity. Proper ESD control techniques should be used when handling these HBM Class 1A devices.

Typical Performance Curves: @ +25°C

Gain

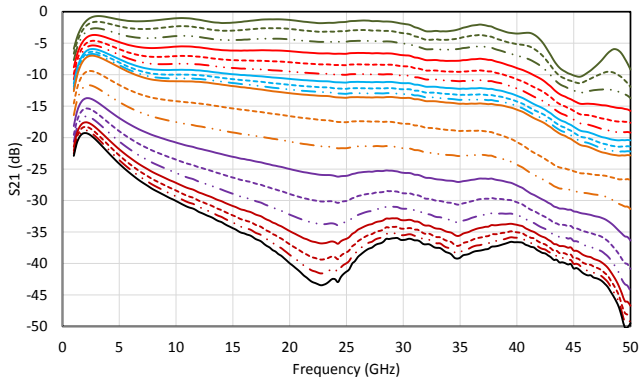

Input Return Loss

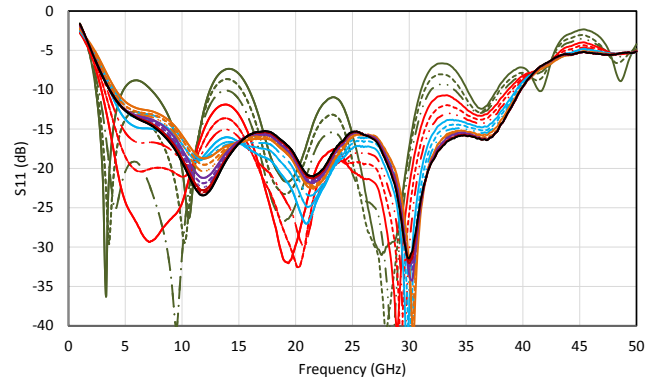

Output Return Loss

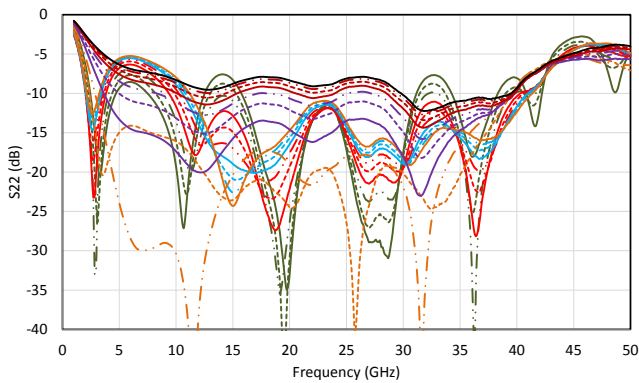

— VC1=-2V, VC2=-2V	--- VC1=-0.8V, VC2=-2V
- - VC1=-0.7V, VC2=-2V	- - VC1=-0.6V, VC2=-2V
- - - VC1=-0.5V, VC2=-2V	- - - VC1=-0.4V, VC2=-2V
- - - - VC1=-0.3V, VC2=-2V	- - - - VC1=-0.2V, VC2=-2V
- - - - - VC1=-0.1V, VC2=-2V	- - - - - VC1=0V, VC2=-2V
- - - - - - VC1=0V, VC2=-0.8V	- - - - - - VC1=0V, VC2=-0.7V
- - - - - - - VC1=0V, VC2=-0.6V	- - - - - - - VC1=0V, VC2=-0.5V
- - - - - - - - VC1=0V, VC2=-0.4V	- - - - - - - - VC1=0V, VC2=-0.3V
- - - - - - - - - VC1=0V, VC2=-0.2V	- - - - - - - - - VC1=0V, VC2=-0.1V
- - - - - - - - - - VC1=0V, VC2=0V	

### Typical Performance Curves: S-Parameters @ +25°C

**S-Parameters  $V_{C1} = -2.0 V, V_{C2} = -2.0 V$**

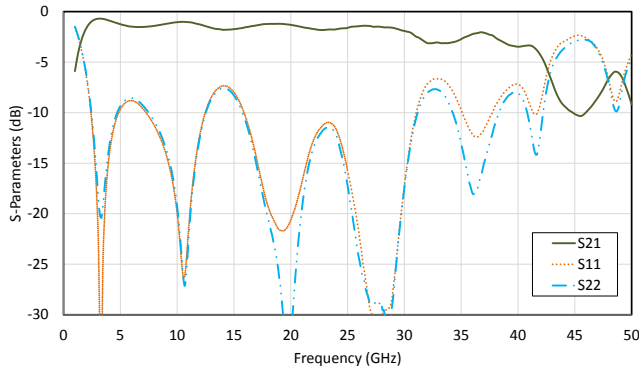

**S-Parameters  $V_{C1} = -0.6 V, V_{C2} = -2.0 V$**

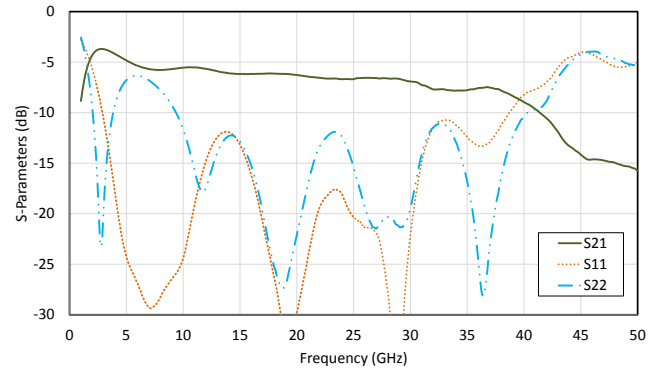

**S-Parameters  $V_{C1} = -0.4 V, V_{C2} = -2.0 V$**

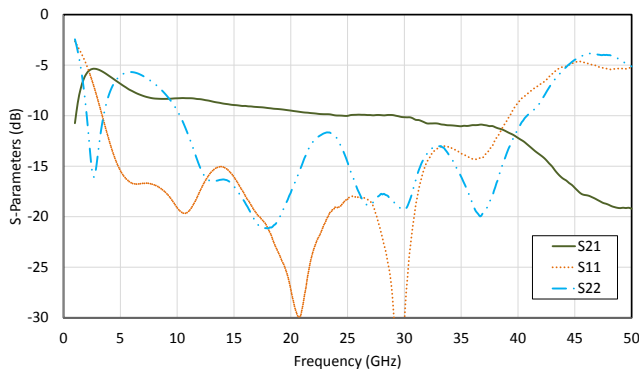

**S-Parameters  $V_{C1} = -0.1 V, V_{C2} = -2.0 V$**

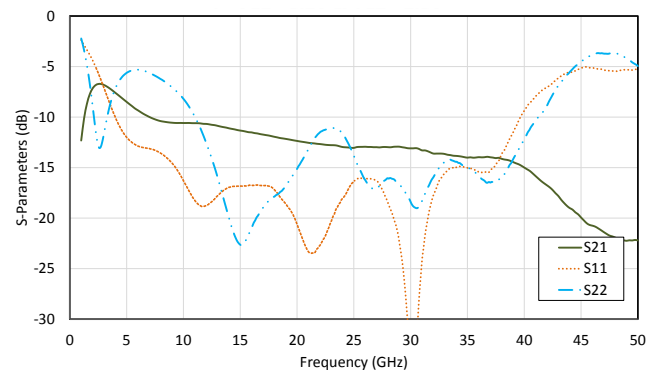

**S-Parameters  $V_{C1} = 0 V, V_{C2} = -0.6 V$**

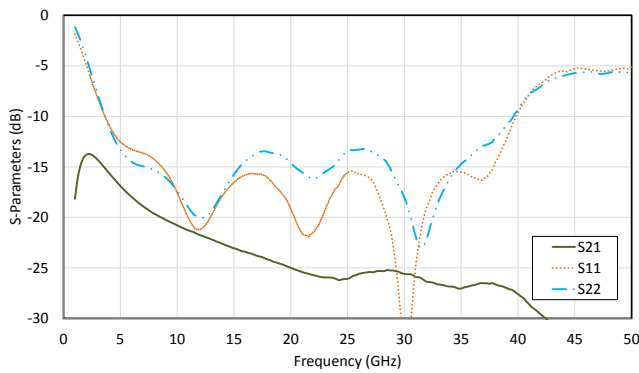

## Typical Performance Curves: Power Gain, Freq. 16 GHz

**Power Gain @  $V_{C1} = -2.0\text{ V}$ ,  $V_{C2} = -2.0\text{ V}$**

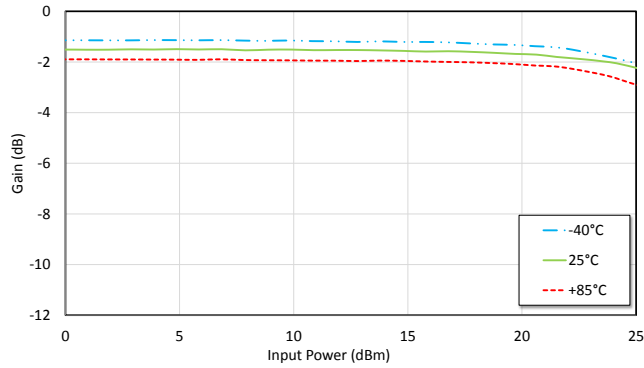

**Power Gain @  $V_{C1} = -0.4\text{ V}$ ,  $V_{C2} = -2.0\text{ V}$**

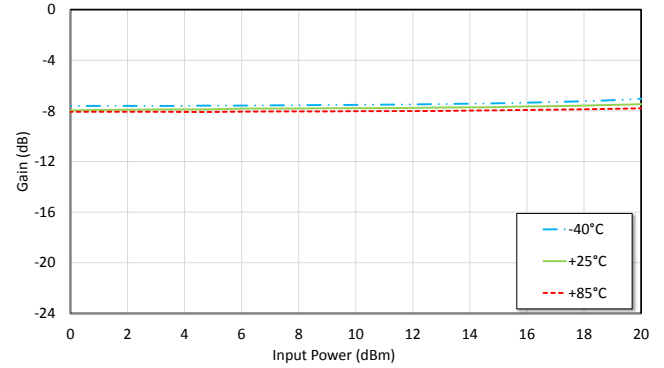

**Power Gain @  $V_{C1} = 0\text{ V}$ ,  $V_{C2} = -2.0\text{ V}$**

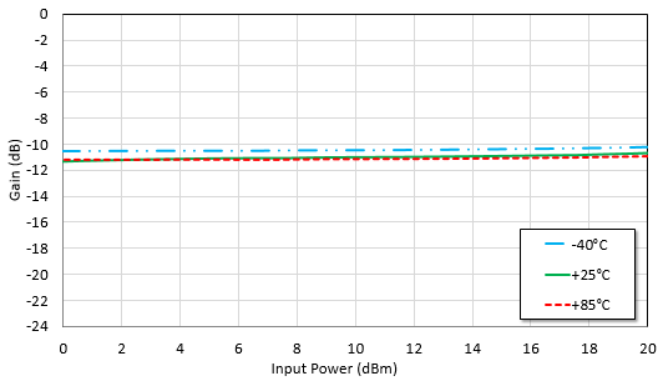

## Voltage Variable Attenuator 5 - 45 GHz

Rev. V1

### Typical Performance Curves: Power Gain @ +25°C

Power Gain @  $V_{C1} = -2.0\text{ V}$ ,  $V_{C2} = -2.0\text{ V}$

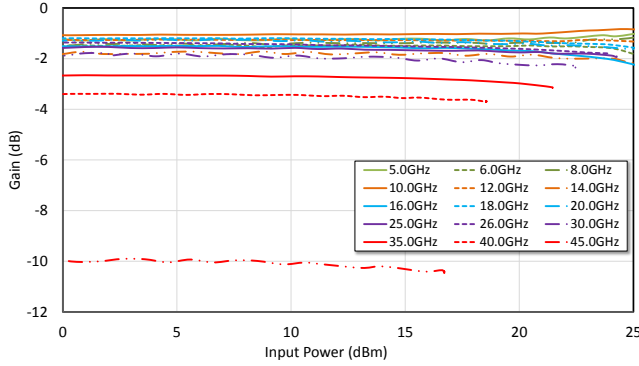

Power Gain @  $V_{C1} = 0\text{ V}$ ,  $V_{C2} = -2.0\text{ V}$

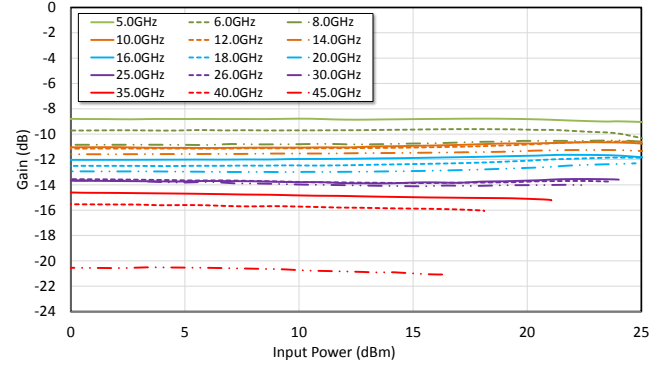

Power Gain @  $V_{C1} = -0.4\text{ V}$ ,  $V_{C2} = -2.0\text{ V}$

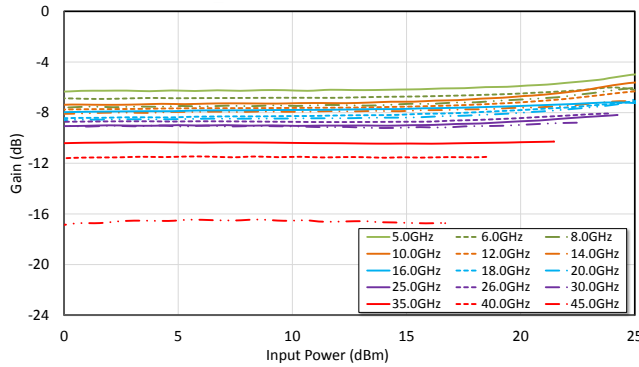

Power Gain @  $V_{C1} = 0\text{ V}$ ,  $V_{C2} = -0.6\text{ V}$

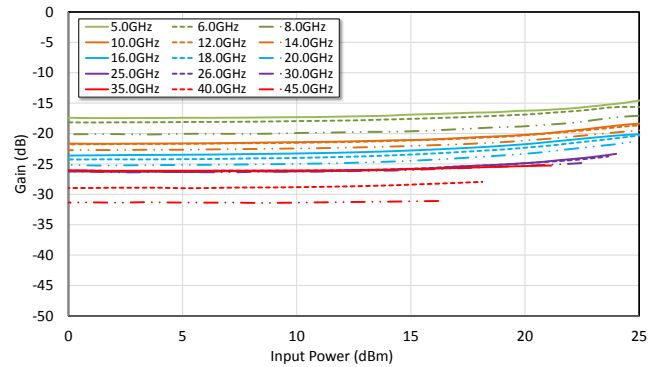

Power Gain @  $V_{C1} = 0\text{ V}$ ,  $V_{C2} = 0\text{ V}$

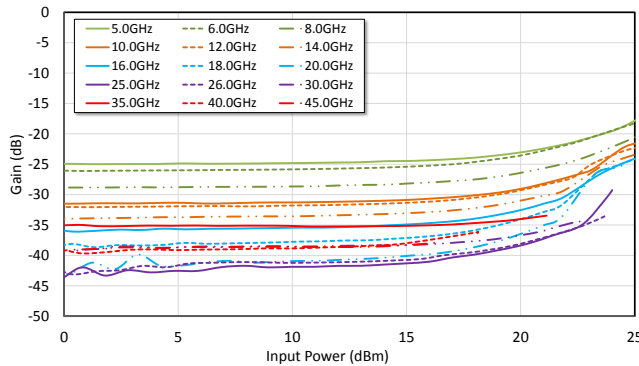

## Voltage Variable Attenuator 5 - 45 GHz

Rev. V1

### Typical Performance Curves: Input IP3

**Input IP3 vs. Frequency**  
@  $V_{C1} = -2.0\text{ V}$ ,  $V_{C2} = -2.0\text{ V}$

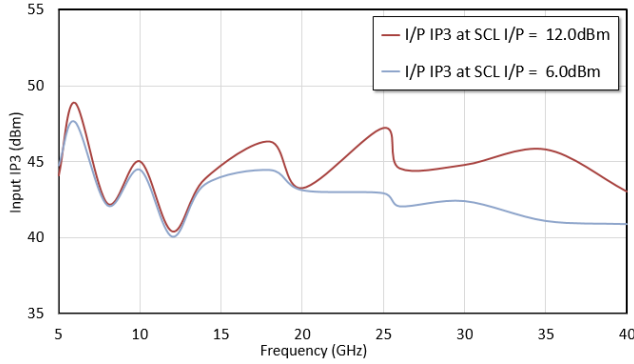

**Input IP3 vs. SCL Input Power**  
@  $V_{C1} = -2.0\text{ V}$ ,  $V_{C2} = -2.0\text{ V}$

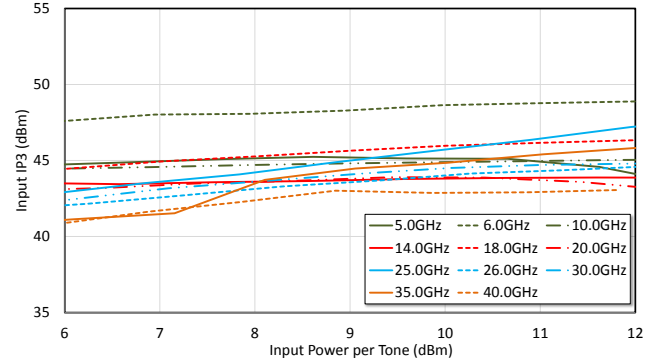

**Input IP3 vs. Attenuation, SCL  $P_{IN} = 6\text{ dBm}$**

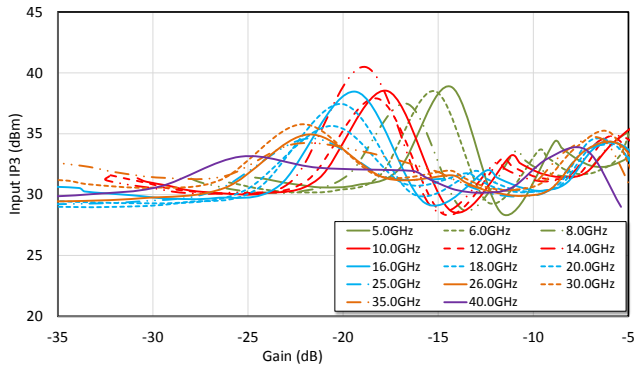

**Input IP3 vs. Attenuation, SCL  $P_{IN} = 12\text{ dBm}$**

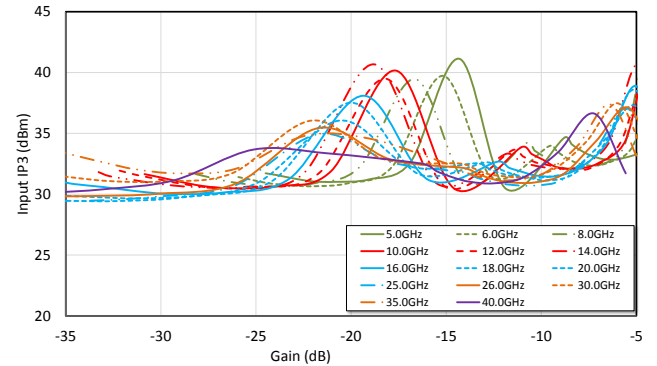





MACOM Technology Solutions Inc. All rights reserved.

Information in this document is provided in connection with MACOM Technology Solutions Inc ("MACOM") products. These materials are provided by MACOM as a service to its customers and may be used for informational purposes only. Except as provided in MACOM's Terms and Conditions of Sale for such products or in any separate agreement related to this document, MACOM assumes no liability whatsoever. MACOM assumes no responsibility for errors or omissions in these materials. MACOM may make changes to specifications and product descriptions at any time, without notice. MACOM makes no commitment to update the information and shall have no responsibility whatsoever for conflicts or incompatibilities arising from future changes to its specifications and product descriptions. No license, express or implied, by estoppels or otherwise, to any intellectual property rights is granted by this document.

THESE MATERIALS ARE PROVIDED "AS IS" WITHOUT WARRANTY OF ANY KIND, EITHER EXPRESS OR IMPLIED, RELATING TO SALE AND/OR USE OF MACOM PRODUCTS INCLUDING LIABILITY OR WARRANTIES RELATING TO FITNESS FOR A PARTICULAR PURPOSE, CONSEQUENTIAL OR INCIDENTAL DAMAGES, MERCHANTABILITY, OR INFRINGEMENT OF ANY PATENT, COPYRIGHT OR OTHER INTELLECTUAL PROPERTY RIGHT. MACOM FURTHER DOES NOT WARRANT THE ACCURACY OR COMPLETENESS OF THE INFORMATION, TEXT, GRAPHICS OR OTHER ITEMS CONTAINED WITHIN THESE MATERIALS. MACOM SHALL NOT BE LIABLE FOR ANY SPECIAL, INDIRECT, INCIDENTAL, OR CONSEQUENTIAL DAMAGES, INCLUDING WITHOUT LIMITATION, LOST REVENUES OR LOST PROFITS, WHICH MAY RESULT FROM THE USE OF THESE MATERIALS.

MACOM products are not intended for use in medical, lifesaving or life sustaining applications. MACOM customers using or selling MACOM products for use in such applications do so at their own risk and agree to fully indemnify MACOM for any damages resulting from such improper use or sale.