

V-Series

V-Series

CONTURA II, III SWITCHES

The V-Series Contura II & III snap-in rocker switches offer countless unique options including choices for ratings, circuits, colors, illuminations and symbols. These single or double pole switches feature removable actuators in a choice of actuator styles and colors, and can be illuminated with either square or bar shaped lenses. Actuators may be purchased and stocked separately. An optional plug-in terminal connector enables pre-wiring of wire harnesses.

The Contura switches with sealed option, are certified to IP66, signifying complete protection against dust and prolonged spray and submersion under pressure, and are recognized to UL1500 - Ignition Protection for Marine Products. These switches are vibration, shock, thermoshock, moisture and salt spray resistant. Temperature ratings range from -40°C to +85°C.



Resources:

Download 3D CAD Files



Watch Product Video



Product Highlights:

- ♦ Countless options for ratings, circuits, colors, illuminations and legends
- ♦ Certified to IP66 for front panel components
- ♦ Vibration, shock, thermoshock, moisture and salt spray resistant
- ♦ Temperature range from -40°C to +85°C.

Typical Applications:

- ♦ On/Off Highway Equipment
- ♦ Marine
- ♦ Military Armored Vehicles
- ♦ Mining Machinery and Equipment
- ♦ Any application requiring environmental protection



V-Series Switch

DESIGN FEATURES

INTERCHANGEABLE ACTUATORS

Panel redesign is a snap with our wide range of rocker styles. Achieve maximum design variety with minimum inventory. Simply swap rockers to create an entirely new look for your panel.

DUAL SEAL PROTECTION

Seals out water, dust, debris, and enables switch certification to IP66 for front panel components.

CLEAN CONNECTIONS

Options for both eight and ten terminal base styles with AMP & Packard compatible connectors affords myriad circuit options while providing ease of assembly.

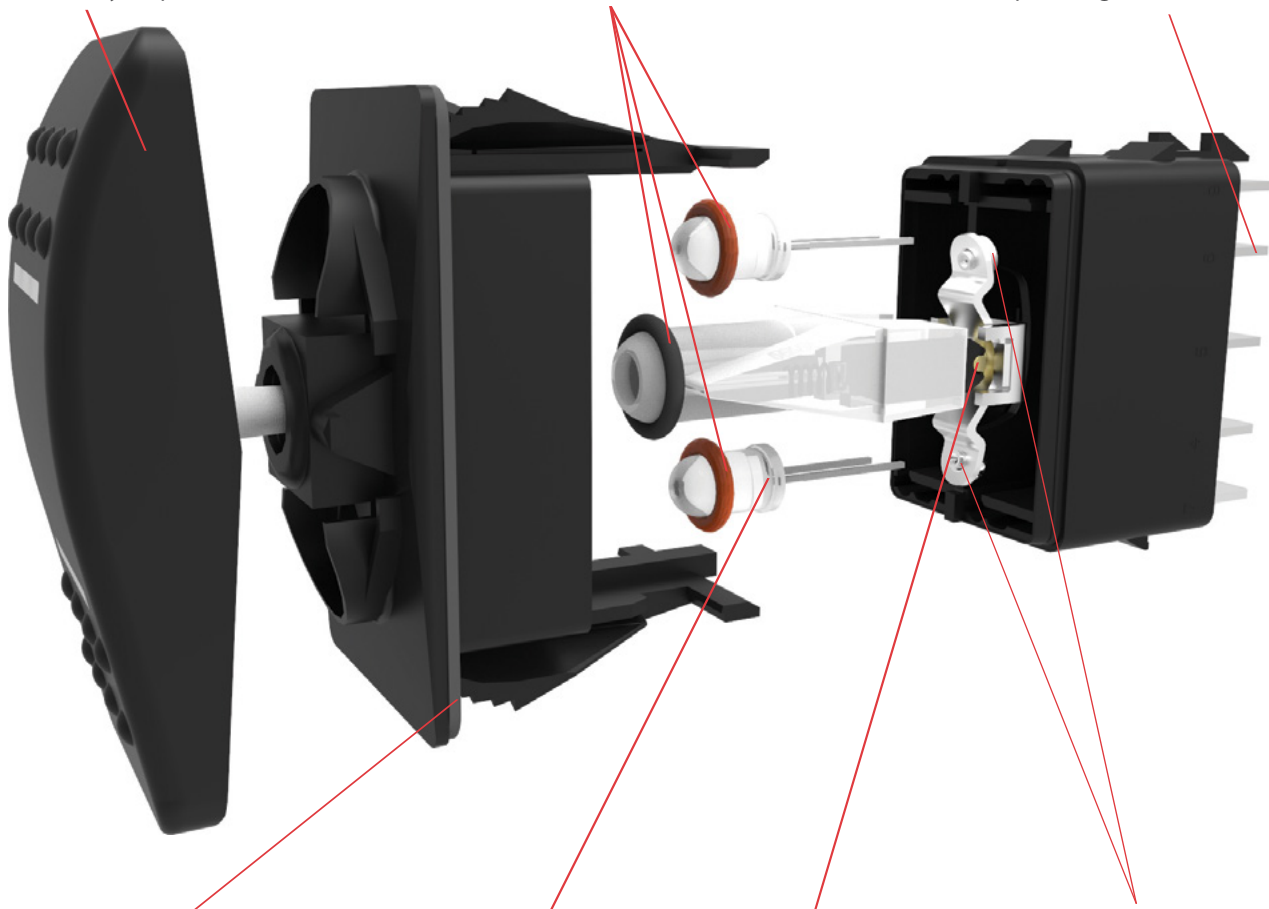

OPTIONAL PANEL SEAL

Prevents water/dust ingress behind panel.

MULTIPLE LIGHTING OPTIONS

In addition to Incandescent lamps, our LED illumination is offered in a wide array of light intensities, colors, as well as dual level, tri-color, and flashing options.

BRASS ROLLER PIN

Robust mechanism eliminates the need for lubricants. Enables switch to withstand -40°C to +85°C temperatures.

SILVER PLATED BUTT CONTACT MECHANISM

Providing 50k to 100k electrical cycles and a variety of different electrical ratings.

*Manufacturer reserves the right to change product specification without prior notice.

Contura II & III

The Contura II & III actuators are constructed of thermoplastic polycarbonate and are offered with a hard nylon overlay or a "soft-touch" elastomer overlay. These models incorporate aesthetic designs on the top and bottom of the rocker featuring two rows of raised "bumps" on the Contura II and three "indented" lines on the Contura III.



Contura X

The raised bracket/bezel on the Contura X helps prevent inadvertent actuation of the rocker, as well as preventing debris from being trapped under the actuator. This curved rocker style is available with a variety of lenses and legends.



Contura IV

The Contura IV's "Shape to create a Shape" actuator works with the curves, contours & advanced styling of the latest panel designs, flowing with these advanced curves & radii. This actuator style fits on the Contura flush bracket/bezel.



Contura XI

The raised bracket/bezel on the Contura XI helps prevent inadvertent actuation of the rocker, as well as preventing debris from being trapped under the actuator. This convex style rocker is available with a wide variety of lenses and legends.



Contura V

The symmetrically curved Contura V actuator provides the perfect complement to the Contura IV's "Shape to create a Shape" design concept. With its flush style mounting bracket, Contura V can be mounted in between two Contura IV's, by itself, or in groups.



Contura XII

The Contura XII version features a paddle style actuator with the raised bracket/bezel of Contura X and XI. The contoured handle design provides intuitive recognition and ease of operation and is available with all Contura X and XI lens and legend offerings.



Contura VI (WAVE)

The Contura VI WAVE sealed rocker switches, when used in a row, create an uniquely appealing "wave" design on your panel. A variety of colors and finishes are available for both rocker and wave insert. Contura VI features bar and oval lenses.



Contura XIV

The Contura XIV represents a sleek new crossover rocker design which should appeal to Trucks, Buses and Heavy Vehicles as well as the Marine Industry. Intuitive feel is provided by recessed ridges along with a Center Groove which effectively defines the boundary between top and bottom switch functions.



Contura VII

Contura VII featuring gently curved corners and edges assuring compatibility with most any panel design. Intuitive feel is maximized by the use of 2 embossed circular pads located at opposite ends of the rocker. Any combination of Bar or Oval style lenses can be located in the pads providing a truly unique look, exclusive to Contura VII.



Illuminated Indicators & Accessories

Alert operator of systems functions or malfunctions, are offered with removable/replaceable lamps in Contura II, II, V or X styles. Accessories include connectors, mounting panels, hole plugs, panel seals, and actuator removal tools. Refer to accessories page for full details



Electrical

| | |
|----------------------------|---|
| Contact Rating | .4VA @ 24VDC (MAX) resistive 15 amps, 125VAC 10 amps, 250VAC 1/2 HP 125-250VAC 20 amps, 4-14VDC 15 amps, 15-28VDC 10A, 14VT 6A, 125VAC L |
| Dielectric Strength | 1500 Volts RMS |
| Insulation Resistance | 50 Megohms |
| Initial Contact Resistance | 10 milliohms max. @ 4VDC |
| Life | 50,000 - 100,000 cycles circuit dependent |
| Contacts | Silver alloy, silver tin-oxide, fine silver |
| Terminals | Brass or copper/silver plate 1/4" (6.3mm) Quick Connect terminations standard. Solder lug, Wire Lead |

Mechanical

| | |
|-----------|--|
| Endurance | 150,000 cycles minimum circuit dependent |
|-----------|--|

Physical

| | |
|---------------------------------------|---|
| Lighted | Incandescent - rated 10,000 hours Neon - rated 25,000 hours LED - rated 100,000 hours 1/2 life (LED is internally ballasted for voltages to 24VDC) |
| Seals | Internal |
| Base | Optional external gasket panel seal Polyester blend rated to 125°C with a UL flammability rating of 94V0. |
| Contura II,III,IV,V, VI, VII Actuator | Hard Surface: Basic actuator structure molded of thermoplastic polycarbonate with a hard Nylon 66 thermoplastic surface overlay. Soft Surface: Basic actuator structure molded of thermoplastic polycarbonate with an elastomer overlay. |
| Contura X,XI,XII Actuator,VP | Nylon 66 Reinforced rated to 105°C |
| Lens | Polycarbonate rated at 100°C |
| Contura XIV | Polycarbonate lens/sub-rocker with ABS shell |

Actuator Travel (Angular Displacement)

| | |
|-------------|----------------|
| 2 position | 18° |
| 3 positions | 9° from center |

Mounting Specifications

Panel Thickness Range

Gaskets Acceptable Panel Thickness

| | |
|---|--|
| 0 | .030 to .250 (.76 to 6.35mm) |
| 1 | .030 to .109 & .147 to .157 (.76 to 2.77mm & 3.73 to 3.98mm) |

Recommended: No gasket with panel thickness of .032, .062, .093, .125, .187 or .250



Agency Certifications



Environmental

| | |
|---------------------|---|
| Sealing | Sealed version: IP66, this rating applies to front panel components of the actual switch only, and signifies complete protection against dust as well as powerful jets of water. |
| Corrosion | Mixed Flowing Gas (MFG) Class III 3 year accelerated exposure per ASTM B-827, B-845 Silver and gold contacts |
| Operating Temp. | -40°C to +85°C |
| Vibration 1 | Per Mil-Std 202F, Method 204D Test Condition A 0.06 DA or 10G's 10-500 Hz. Tested with VCH connector. Test criteria - No loss of circuit during test, pre and post test contact resistance. |
| Vibration 2 | Resonance search 24-50 Hz 0.40 DA 50-2000 Hz ±10 G's peak Horizontal Axis 3-5 G's max. Random 24 Hz 0.06 PSD-Gsq/Hz 60 Hz 0.50 100 Hz 0.50 200 Hz 0.025 2000 Hz 0.025 No loss of circuit during test; <10µ seconds chatter. |
| Shock | Per Mil-Std 202F, Method 213B, Test Condition K @ 30G's. Tested with VCH connector. Test criteria - No loss of circuit during test, pre and post test contact resistance. |
| Salt Spray | Per Mil-Std 202F, Method 101D, Test Condition A, 96 Hrs. Sealed version only. |
| Dust | Mil STD 810, Method 510.2 Air Velocity 300 Ft/Min Duration 16Hr |
| Thermal Shock | Per Mil-Std 202F, Method 107F, Test Cond. A, -55°C to +85°C. Test criteria - pre and post test contact resistance |
| Moisture Resistance | Per Mil-Std 202F, Method 106F, Test Criteria - pre and post test contact resistance |
| Ignition Protection | All Contura switches with sealed construction meet the requirements of UL1500/ISO8846 for ignition protection, in addition to conformance with EC directive 94/25/EC for marine products. |

V 1 D A B T O B - A R B 00 - 0 00

1 Series 2 Circuit 3 Rating 4 Termination Illumination Lamp 5 Lamp 6 Lamp 7 Lamp 8 Bracket 9 Actuator 10 Lens 11 Color 12 Legend 13 Legend Orientation 14 Actuator Lens Legend

1 SERIES

V

2 CIRCUIT

Terminal Connections as viewed () - momentary from bottom of switch: SP - single pole - uses terminals 1, 2 & 3. **8 terminal 10 terminal** DP - double pole uses terminals 1, 2, 3, 4, 5 & 6. Terminals 7, 8, 9 & 10 for lamp circuit only.

8 - -7 8 - -7
1 - -4 1 - -4
2 - -5 2 - -5
3 - -6 3 - -6
10 - -9

| Position: | 1 | 2 | 3 |
|-----------|--------------|---------------------|--------------|
| SP DP | 2 & 3, 5 & 6 | Connected Terminals | 1 & 2, 4 & 5 |
| 1 A | ON | NONE | OFF |
| 2 B | (ON) | NONE | OFF |
| 3 C | ON | NONE | (OFF) |
| 4 D | ON | NONE | ON |
| 5 F | ON | NONE | (ON) |
| 6 J | ON | OFF | ON |
| 7 K | ON | OFF | (ON) |
| 8 L | (ON) | OFF | (ON) |

SPECIAL CIRCUITS

| | 2 & 3 | 2 & 3, 5 & 4 | 5 & 4 |
|----|----------------|--------------|-------|
| H* | 2 & 3 | 2 & 3, 5 & 4 | 5 & 4 |
| G* | 2 & 3, 5 & 6 | 2 & 3 | OFF |
| S* | 2 & 3, 5 & 6 | 2 & 3 | 1 & 2 |
| M* | (2 & 3, 5 & 6) | 2 & 3 | OFF |
| R* | (2 & 3, 5 & 6) | 2 & 3 | 2 & 1 |
| E* | 5 & 6 | 5 & 3 | 5 & 1 |

*Jumper between terminals 2 & 5 for circuits H, G, M, R & S are specified in selection 4. External jumper between terminals 2 & 4 for circuit E are provided by customer. Circuit E may be used for SP OFF-ON-ON circuit.

3 RATING 3

| | |
|---|--|
| 1 | .4VA @ 28VDC Resistive |
| B | 15A 24V |
| C | 20A 18V |
| D | 20A 12V |
| E | 20A 14V, 10A 14VT (circuit 1, 4, A & D only) |
| F | 10A 14V, 6A 14VT (circuit G only) |
| M | .4VA/20A 12V |
| N | .4VA/15A 24V |

4 TERMINATION / BASE STYLE

| 8 term | 10 Term | Termination | Jumper |
|--------|---------|-----------------------------|-------------|
| 1 | 2 | .250 TAB (QC) no barriers | No |
| A | B | .250 TAB (QC) with barriers | No |
| J | K | .250 TAB (QC) no barriers | Yes T2 to 5 |
| 3 | 5 | Solder Lug no barriers | No |
| C | D | Solder Lug | No |
| 5 | 6 | Wire Leads no barriers | No |
| E | F | Wire Leads | No |

Note: Codes J & K for circuits H, G & M.

5 ILLUMINATION

Lamp #1: above terminals 1 & 4 end of switch.; Lamp #2 above terminals 3 & 6 end of switch. Positive (+) and negative (-) symbols apply to LED lamps only

| Sealed | Unsealed | Lamps | Illumination Type | Lamp wired to Terminals |
|----------------------------------|----------|-------|-------------------|-------------------------|
| S | 0 | NONE | - | - |
| A | 1 | 1 | INDEPENDENT | 8 (+) 7 (-) |
| B | 2 | 1 | DOWN | 3 (+) 7 (-) |
| C | 3 | 2 | UP | 3 (+) 7 (-) |
| D | 4 | 1 | DOWN | 3 (+) 7 (-) |
| | | 2 | DOWN | 1 (+) 7 (-) |
| E | 5 | 1 | UP | 1 (+) 7 (-) |
| | | 2 | UP | 3 (+) 7 (-) |
| F | 6 | 1 | INDEPENDENT | 8 (+) 7 (-) |
| | | 2 | UP | 3 (+) 6 (-) |
| G | 7 | 1 | INDEPENDENT | 8 (+) 7 (-) |
| | | 2 | UP | 3 (+) 7 (-) |
| H | Z | 2 | INDEPENDENT | 8 (+) 7 (-) |
| U | Y | 1 | INDEPENDENT | 8 (+) 7 (-) |
| | | 2 | INDEPENDENT | 10 (+) 9 (-) |
| SINGLE POLE SWITCHES ONLY | | | | |
| J | 8 | 1 | DOWN | 3 (+) 8 (-) |
| | | 2 | INDEPENDENT | 6 (+) 7 (-) |
| K | W | 1 | INDEPENDENT | 8 (+) 7 (-) |
| | | 2 | INDEPENDENT | 6 (+) 7 (-) |
| DOUBLE POLE SWITCHES ONLY | | | | |
| L | 9 | 1 | DOWN | 3 (+) 6 (-) |
| M | R | 1 | UP | 3 (+) 6 (-) |
| N | T | 1 | DOWN | 3 (+) 6 (-) |
| | | 2 | DOWN | 1 (+) 4 (-) |
| P | V | 1 | UP | 1 (+) 4 (-) |
| | | 2 | UP | 3 (+) 6 (-) |

6,7 LAMP (SAME CODING FOR BOTH SELECTIONS)

Selection 6: above terminals 1 & 4; Selection 7: above terminals 3 & 6

| | | | | | |
|-------------------|----------|----------|-------------------|-------------------|-------------------|
| No lamp | 0 | 2 250VAC | | | |
| Neon | 1 125VAC | 5 6V | 6 12V superbright | 7 18V superbright | 8 24V superbright |
| Incandescent LED* | 4 3V | | Green | Red | |
| | Red | Amber | F | R | |
| 2VDC | A | L | G | S | |
| 6VDC | B | M | H | T | |
| 12VDC | C | N | J | V | |
| 24VDC | D | P | K | W | |

* Consult factory for "daylight bright" LED options. Typical current draw for LED is 20ma.

8 FLUSH BRACKET COLOR 1, PANEL SEAL

| | | | |
|----------|-------|-------|------|
| No Seal | Black | White | Gray |
| One Seal | B | W | G |
| | C | Y | H |

9 ACTUATOR

| | |
|------|-------------|
| 0 | No Actuator |
| A, B | Contura II |
| C, D | Contura III |

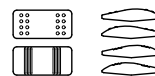

Actuator orientation above terminals: 3,6 1,4

10 LENS

| 0 - No Actuator | Z - No Lens | |
|-----------------|----------------------|--|
| Clear White | Amber Green Red Blue | |
| 1 6 8 | G M T | |
| 2 7 C | H N U | |
| 3 8 D | J P V | |
| 4 9 E | K R W | |
| 5 A F | L S Y | |

Lens color for LEDs must be clear, white, or match color of LED. Green or blue lenses are not recommended with Neon lamps.

11 ACTUATOR COLOR 1 AND TEXTURE

| | | | | |
|-----------------|-------|------|-----|-------|
| 0 - No Actuator | Black | Gray | Red | White |
| Soft Surface | B | G | R | W |
| Hard Surface | C | H | S | Y |

12 ACTUATOR LENS OR BODY LEGENDS 2

| | | | |
|--------|--------|--------|--------|
| 11 ON | 12 OFF | 13 I | 14 O |
| OFF | ON | O | I |
| 15 O O | 16 O O | 17 O I | 18 I O |
| F N | N F | F | F |

For additional legend options & codes, visit us at www.carlingtech.com.

13 LEGEND ORIENTATION

0 No legend (used with codes 11-18 in selection 12)

| | | |
|---|---------------|--|
| 1 | Orientation 1 | |
| 2 | Orientation 2 | |
| 3 | Orientation 3 | |
| 4 | Orientation 4 | |

14 ACTUATOR LENS LEGEND

00 No legend this location / no actuator (used with codes 11-18 in selection 12) Selection 14 required when switch requires two legends. If the two legends consist of one lens and one body legend, lens legend must be specified in selection 12; body legend specified in selection 14. For legend options & codes, visit us at www.carlingtech.com.

Notes:

- Consult factory to verify horsepower rating for your particular circuit choice.
- 1 Custom colors are available. Consult factory.
- 2 Body legends not available on Soft surface actuators; White imprinting is standard on black actuators; Black imprinting is standard on white, red and gray actuators. Custom colors are available, consult factory.
- 3 Additional ratings available. See V-Series Switch Accessories page.
- 4 Contura II available with two square lenses. Consult factory for details.

V 1 D A S W O B - A Z E 00 - 0

1 Series 2 Circuit 3 Rating 4 Termination Illumination Lock 5 Lamp 6 Bracket 7 Actuator 8 Lens 9 Function 10 Legend 11 Legend 12 Legend 13 Legend Orientation

1 SERIES
V

2 CIRCUIT
Terminal Connections as viewed () - momentary from bottom of switch: SP - single pole - uses terminals 1, 2 & 3. DP - double pole uses terminals 1, 2, 3, 4, 5 & 6.
8 terminal 10 terminal Terminals 7, 8, 9 & 10 for lamp circuit only.

| | | |
|-------|--------|---|
| 8 - 7 | 8 - 7 | Terminals 7, 8, 9 & 10 for lamp circuit only. |
| 1 - 4 | 1 - 4 | |
| 2 - 5 | 2 - 5 | |
| 3 - 6 | 3 - 6 | |
| | 10 - 9 | |

Position:

| SP | DP | 1 | 2 | 3 |
|----|----|--------------|-----------|--------------|
| A | | 2 & 3, 5 & 6 | Connected | 1 & 2, 4 & 5 |
| D | | ON | NONE | OFF |
| J | | ON | OFF | ON |
| K | | ON | OFF | (ON) |
| L | | (ON) | OFF | (ON) |
| N | | OFF | NONE | ON |

SPECIAL CIRCUITS

| | 2 & 3 | 2 & 3, 5 & 6 | 2 & 3, 5 & 4 | 5 & 4 |
|----|----------------|--------------|--------------|-------|
| G* | 2 & 3 | 2 & 3 | 2 & 3 | OFF |
| S* | 2 & 3, 5 & 6 | 2 & 3 | 2 & 3 | 1 & 2 |
| M* | (2 & 3, 5 & 6) | 2 & 3 | 2 & 3 | OFF |
| R* | (2 & 3, 5 & 6) | 2 & 3 | 2 & 3 | 2 & 1 |
| E* | 5 & 6 | 5 & 3 | 5 & 3 | 5 & 1 |

*Jumper between terminals 2 & 5 for circuits H, G, M, R & S are specified in selection 4. External jumper between terminals 2 & 4 for circuit E are provided by customer. Circuit E may be used for SP OFF-ON-ON circuit.

3 RATING 4

1 .4VA @ 28VDC Resistive
B 15A 24V
C 20A 18V
D 20A 12V
E 20A 14V, 10A 14VT (circuit 1, 4, A & D only)
F 10A 14V, 6A 14VT (circuit G only)
M 4VA/20A 12V
N .4VA/15A 24V

4 TERMINATION / BASE STYLE

| 8 term | 10 Term | Termination | Jumper |
|--------|---------|-----------------------------|-------------|
| 1 | 2 | .250 TAB (QC) no barriers | No |
| A | B | .250 TAB (QC) with barriers | No |
| J | K | .250 TAB (QC) no barriers | Yes T2 to 5 |
| 3 | 5 | Solder Lug no barriers | No |
| C | D | Solder Lug | No |
| E | F | Wire Leads no barriers | No |
| 5 | F | Wire Leads | No |

Note: Codes J & K for circuits H, G & M.

5 ILLUMINATION & SWITCH SEALING
Lamp #1: above terminals 1 & 4 end of switch.; Lamp #2 above terminals 3 & 6 end of switch. Positive (+) and negative (-) symbols apply to LED lamps only

| Sealed | Unsealed | Lamps | Illumination Type | Lamp wired to Terminals |
|--------|----------|-------|-------------------|-------------------------|
| S | 0 | NONE | - | 3 (+) 7 (-) |
| H | 3 | 2 | UP | 8 (+) 7 (-) |
| C | Z | 2 | INDEPENDENT | 8 (+) 7 (-) |

DOUBLE POLE SWITCHES ONLY

| | | | | |
|---|---|---|----|-------------|
| M | R | 1 | UP | 3 (+) 6 (-) |
|---|---|---|----|-------------|

6 LOCK
Lock above terminals 1 & 4 end of switch
W lock

7 LAMP
Lamp above terminals 3 & 6 end of switch

| | | | | | |
|--------------|---|--------|---|-----------------------|-----------------------|
| No lamp | 0 | | | | |
| Neon | 1 | 125VAC | 2 | 250VAC | |
| Incandescent | 4 | 3V | 5 | 6V | |
| LED* | | | 6 | 12V superbright Green | 7 18V superbright Red |
| 2VDC | A | Red | L | Amber | F |
| 6VDC | B | | M | | G |
| 12VDC | C | | N | | H |
| 24VDC | D | | P | | J |

* Consult factory for "daylight bright" LED options. Typical current draw for LED is 20ma.

8 FLUSH BRACKET COLOR 1, PANEL SEAL

| | | | |
|----------|-------|-------|------|
| | Black | White | Gray |
| No Seal | B | W | G |
| One Seal | C | Y | H |

9 HARD SURFACE ACTUATOR 1

| | | | | |
|-------------|-------|------|-----|-------|
| | Black | Gray | Red | White |
| Contura II | A | B | G | H |
| Contura III | C | D | E | F |

Actuator orientation above terminals:
3.6 1.4

10 LENS
Z - No Lens
Clear White Amber Green Red Blue
3 8 D J P V

Lens color for LEDs must be clear, white, or match color of LED. Green or blue lenses are not recommended with Neon lamps.

11 ACTUATOR LOCK FUNCTION AND COLOR 1

| Lock Color | Up | Down | Up & Down | Center 3 |
|----------------|----|------|-----------|----------|
| Match Actuator | A | H | R | 1 |
| Black | B | J | S | 2 |
| White | C | K | T | 3 |
| Red | D | L | V | 4 |
| Safety Orange | E | M | W | 5 |

12 ACTUATOR LENS OR BODY LEGEND 2
00 - No Legend
21 OFF 22 ON 23 O 24 I

| | | | |
|------|------|------|------|
| 25 O | 26 O | 27 O | 28 I |
| F | N | | |

For additional legend options & codes, visit us at www.carlingtech.com.

13 LEGEND ORIENTATION

| | |
|---|---|
| 0 | No legend (used with codes 21-28 in selection 12) |
| 1 | Orientation 1 |
| 2 | Orientation 2 |
| 3 | Orientation 3 |
| 4 | Orientation 4 |

1 2 3 4

Notes:
Consult factory to verify horsepower rating for your particular circuit choice.

- Custom colors are available. Consult factory.
- White imprinting is standard on black actuators; Black imprinting is standard on white, red and gray actuators. Custom colors are available, consult factory.
- Only available with 3 position circuits. Center OFF and special circuits only available with center position lock function.
- Additional ratings available. See V-Series Switch Accessories page.

Dimensional Specifications: in. [mm]

CONTURA II

SHOWN WITH SQUARE LENS

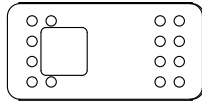

CONTURA III

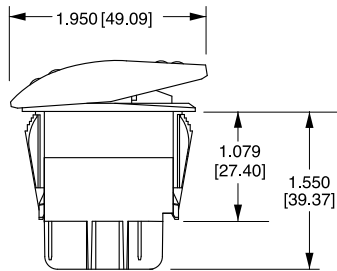
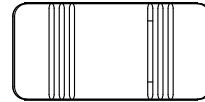

**8 TERMINAL BASE
W/BARRIERS**

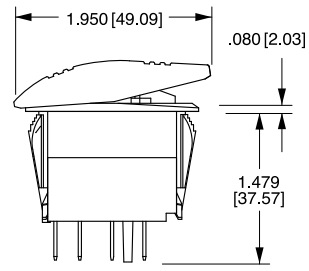

**8 TERMINAL BASE
W/O BARRIERS**

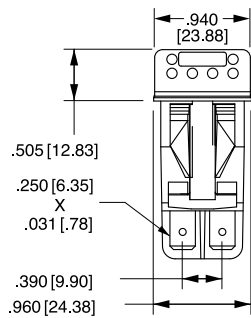

**8 TERMINAL BASE
W/BARRIERS**

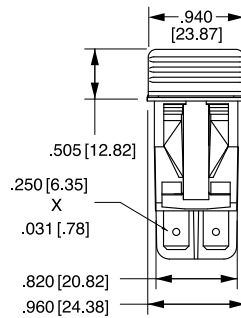

**10 TERMINAL BASE
W/BARRIERS**

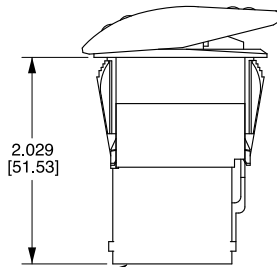

**SWITCH SHOWN WITH
VCH CONNECTOR 8
TERMINAL**

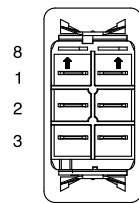

**BOTTOM VIEW
TERMINAL
ARRANGEMENT
8 TERMINAL BASE**

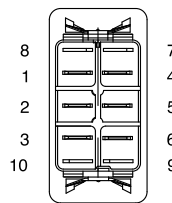

**BOTTOM VIEW
TERMINAL
ARRANGEMENT
10 TERMINAL BASE**

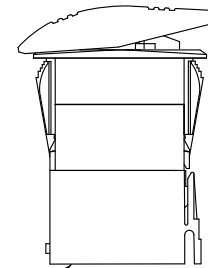

**SWITCH SHOWN WITH
VC1 CONNECTOR 10
TERMINAL**

Circuit Diagrams:

| CIRCUIT CODE | CIRCUIT DIAGRAM |
|--------------|-----------------|
| 1 | |
| 2 | |
| 3 | |
| 4 | |
| 5 | |
| 6 | |
| 7 | |
| 8 | |

| CIRCUIT CODE | CIRCUIT DIAGRAM |
|--------------|-----------------|
| A | |
| B | |
| C | |
| D | |
| E | |
| F | |
| G | |
| H | |

| CIRCUIT CODE | CIRCUIT DIAGRAM |
|--------------|-----------------|
| J | |
| K | |
| L | |
| M | |
| R | |
| S | |

| SYMBOL LEGEND | |
|---------------|---|
| SYM. | DEFINITION |
| | DESIGNATES TERMINALS AND CONTACTS |
| | DESIGNATES MAINTAINED CIRCUITS |
| | DESIGNATES OTHER POSITION |
| | DESIGNATES MOMENTARY CIRCUITS |
| | DESIGNATES TWO POSITION CONNECTION |
| | DESIGNATES EXTERNAL JUMPER PROVIDED BY CUSTOMER |

Lamp Circuit Diagrams:

| LAMP CIRCUIT CODE | CIRCUIT DIAGRAM | LAMP CIRCUIT CODE | CIRCUIT DIAGRAM | LAMP CIRCUIT CODE | CIRCUIT DIAGRAM | LAMP CIRCUIT CODE | CIRCUIT DIAGRAM |
|-------------------|-----------------|-------------------|-----------------|-------------------|-----------------|-------------------|-----------------|
| A / 1 | | F / 6 | | L / 9 | | SPECIAL #1 | |
| B / 2 | | G / 7 | | M / R | | SPECIAL #3 | |
| C / 3 | | H / Z | | N / T | | SPECIAL #4 | |
| D / 4 | | J / 8 | | P / V | | | |
| E / 5 | | K / W | | U / Y | | | |

J-Series Hazard Warning Circuit Diagrams:

| CIRCUIT CODE | CIRCUIT DIAGRAM | CIRCUIT CODE | CIRCUIT DIAGRAM |
|--------------|-----------------|--------------|-----------------|
| J1 | | J5 | |
| J2 | | JA | |
| J3 | | JJ | |
| J4 | | JK | |

NOTE:
J circuits are available for all non-locking V-Series styles.
Consult factory for partnumber details.

| SYMBOL LEGEND | |
|---------------|-----------------------------------|
| SYM. | DEFINITION |
| ○ | DESIGNATES TERMINALS AND CONTACTS |
| ○ | DESIGNATES LAMP LOCATION |

Reduce inventory levels and cost by stocking actuators and base switches separately.

Contura II, III, IV, V, VI, VII, X, XI, XII, XIV Base switches separately: specify **V** with code selections 2-8 in the ordering schemes.

Contura II, III, IV, V Actuator only: **VV** with code **A** or **C** for selection 9, & with selections 10-14 in the ordering schemes.

Contura VI Actuator with lenses and inserts only: **VV** with code selections 9-16

Contura II, III, IV, V, VII Actuator only: **VV** with code **A, C, E, G, P** or **Z** for selection 9 & with selections 10-14 in the ordering schemes.

Contura X, XI, XII, XIV actuators with lenses separately: **VV** with code selections 9-14 in the ordering schemes.

Panel Seal: VPS

Contura X & XI actuators without lenses separately:

VVR 6 1 00 1

1 Actuator Separately 2 Actuator Style/Color 3 Lens Opening 4 Actuator Legend 5 Legend Orientation

1 CONTURA X & XI ACTUATOR SEPARATELY
VVR

2 ACTUATOR STYLE & COLOR

| | | | | |
|------------|-------|------|-------|-----|
| | Black | Gray | White | Red |
| Contura X | 1 | 2 | 3 | 4 |
| Contura XI | 6 | 7 | 8 | 9 |

3 LENS OPENING FOR 1

| | | | |
|---|-----------------|---|---|
| 1 | One bar lens | 5 | square lens on top/ bar lens on bottom (Contura X only) |
| 2 | One bar lenses | | |
| 3 | One square lens | | |
| 4 | two square lens | | |

4 ACTUATOR LENS OR BODY LEGEND

00 - No Legend this location

| | | | |
|--------|--------|--------|--------|
| 11 ON | 12 OFF | 13 I | 14 O |
| OFF | ON | O | I |
| 15 O O | 16 O O | 17 O I | 18 I O |
| F N | N F | | |
| F F | F F | | |

For additional legend options & codes, visit us at www.carlingtech.com.

5 LEGEND ORIENTATION 1

| | | | |
|---|---------------|---|---------------|
| 0 | No legend | 1 | Orientation 1 |
| 1 | Orientation 1 | 2 | Orientation 2 |
| 2 | Orientation 2 | 3 | Orientation 3 |
| 3 | Orientation 3 | 4 | Orientation 4 |
| 4 | Orientation 4 | | |

Contura X, XI & XII top piece of 2-piece lens separately:

VVT 1

1 Lens Separately 2 Color

1 TOP OF LENS SEPARATELY
VVT

2 COLOR
1 Clear 2 Smoke 3 White

Contura X, XI & XII actuator lens assembly:



1 piece lens/bar lens are positioned the same as bottom lens for assembly, minus the top lens. Lenses snap in from bottom.

Notes:

- If actuator lens opening for 2 bar or 2 square lenses, legend orientation 0,1, or 2 must be chosen.
- Center of actuator marking not available for Contura XII.
- Legend is not available for bar style lens.
- Not recommended with neon lamps.
- Must also order top piece of 2 piece square lens separately.

Contura XII actuators without lenses separately:

VVP J 1 Z 21 1 00

1 Actuator 2 Style & Color 3 Lens Opening 4 Lens Opening 5 Legend 6 Legend Orientation 7 Legend Orientation

1 CONTURA XII ACTUATOR SEPARATELY
VVP

2 ACTUATOR STYLE & COLOR

J Black K Gray N White M Red

3,4 LENS OPENING FOR

Z No lens 1 Bar lens 2 Square lens

5, 7 LENS OR BODY LEGEND 2

| | | | | |
|----------------|--------|--------|------|------|
| 00 - No Legend | 21 OFF | 22 ON | 23 O | 24 I |
| | 25 O F | 26 O N | 27 O | 28 I |

For additional legend options & codes, visit us at www.carlingtech.com.

6 LEGEND ORIENTATION 3

| | | | |
|---|---------------|---|---------------|
| 0 | No legend | 1 | Orientation 1 |
| 1 | Orientation 1 | 2 | Orientation 2 |

Contura X, XI & XII actuator lens assembly separately:

VVL 2 1 00 0

1 Lens Separately 2 Lens Style 3 Lens Color 4 Legend 5 Legend Orientation

1 CONTURA X, XI & XII LENS SEPARATELY
VVL

2 LENS STYLE 3

1 Bar lens
2 One Piece Square lens
3 Bottom of Two-Piece Square lens⁵

3 TRANSLUCENT LENS COLOR

1 Clear 2 White 3 Amber 4 Green⁴ 5 Red 6 Blue⁴

4 LENS OR BODY LEGEND 2

| | | | | |
|----------------|--------|--------|------|------|
| 00 - No Legend | 21 OFF | 22 ON | 23 O | 24 I |
| | 25 O F | 26 O N | 27 O | 28 I |

For additional legend options & codes, visit us at www.carlingtech.com.

5 LEGEND ORIENTATION 3

| | | | |
|---|---------------|---|---------------|
| 0 | No legend | 1 | Orientation 1 |
| 1 | Orientation 1 | 2 | Orientation 2 |
| 2 | Orientation 2 | 3 | Orientation 3 |
| 3 | Orientation 3 | 4 | Orientation 4 |
| 4 | Orientation 4 | | |

Easily integrate Contura products into your system, with Contura Accessories

Contura Connectors

| Q.C. SELECTION GUIDE | | | | | |
|-------------------------------|-------------|------------------|------------|-----------------------|-------------|
| COMPANY SERIES | PART NO | | WIRE RANGE | | ORIENTATION |
| | PLAIN BRASS | TIN PLATED BRASS | AWG | MM ² (REF) | |
| PACKARD 58 SERIES | 02965580 | | 12 | 3.0 | B |
| | 02965471 | 12010601 | (2)16-14 | (2)1.0-2.0 | |
| | 02965470 | | 16-14 | 1.0-2.0 | |
| | 02965469 | 06288318 | 20-18 | .5-.8 | |
| PACKARD METRI-PACK 630 SERIES | | 12084590 | 10 | 5.0 | A |
| | | 12052224 | 12 | 3.0 | |
| | | 12015870 | 16-14 | 1.0-2.0 | |
| | | 12020035 | (2)22-18 | (2).5-.8 | |
| | | 12015832 | 20-18 | .5-.8 | |
| | | 12052222 | 20-22 | .35-.5 | |
| AMP 250 SERIES FASTIN-FASTON | 60253-1 | 60253-2 | 16-12 | 1.3-3 | B |
| | 42100-1 | 42100-2 | (2) 16 | (2) 1.3 | |
| | 60295-1 | 60295-2 | 18-14 | .8-2 | |
| | | | 22-18 | .3-.9 | |

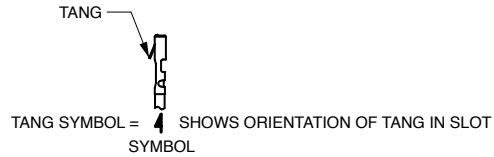

NOTE: Consult Delphi Packard and/or Amp on actual part numbers and availability. AMP is a registered trademark of AMP Inc. Harrisburg, PA. Delphi Packard is a registered trademark of Delphi-Packard Electrical Systems Warren, Ohio

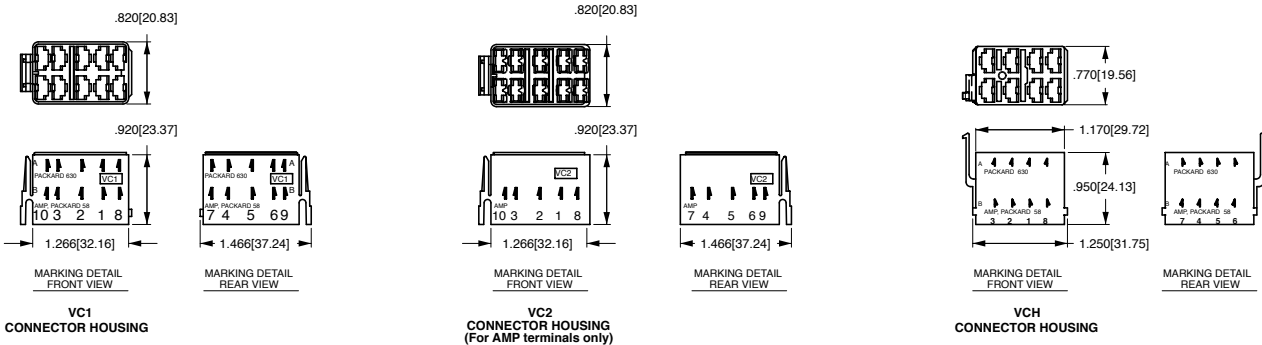

Contura X Boot (P/N VB1-01)

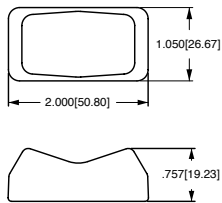

Contura II, III, IV, V, VI & VII Actuator Removal Tool (P/N VRT)

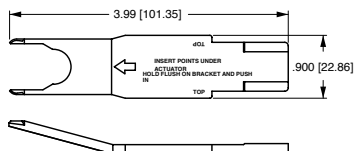

Additional V-Series Ratings

- 1 .4VA @ 28VDC Resistive
- 4 10A 250VAC 1/2 HP, 15A 125 VAC 1/2 HP, No Agency Listings
- 5¹ 10A 250VAC 1/2 HP, 15A 125 VAC 1/2 HP, UL Recognized, CSA Certified
- B 15A 24V
- C 20A 18V
- D 20A 12V
- E 20A 14V, 10A 14VT (circuits 1, 4, A, & D only)
- F 10A 14V, 6A, 14VT (circuit G only)
- G 20A 6V
- H 20A 3V
- L² 15A 125 VAC, 10A 250VAC, 1/2 HP 125-250 VAC; 6A 125 VAC L
- M .4VA/20A 12V (combi-contact)
(combination gold/silver contacts for borderline dry circuit applications)
- N .4VA/15A 24V (combi-contact)
(combination gold/silver contacts for borderline dry circuit applications)

NOTES

- Consult factory to determine availability for individual circuits and their HP rating.
1. Not available with Contura 7 or 14 rocker styles.
 2. Rating L available with circuits 1, 4, A & D only.

Contura Mounting Panels Dimensional Specifications: in. [mm]

MOUNTING PANEL
For additional units, add 1.03[26.2] per unit.
For more than 2 V-Series Switches, add
middle section. Available in Panel Thicknesses
listed below. Consult factory.

MOUNTING PANEL THICKNESS
.062[1.57] .187[4.75]
.093[2.36] .250[6.35]
.125[3.17] .375[9.52]

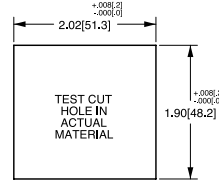
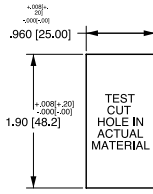

VMS
MOUNTING PANEL
HOLE

MOUNTING PANEL
OPENING
(2) UNITS

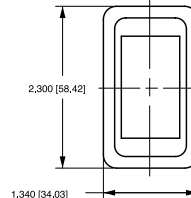
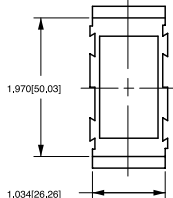
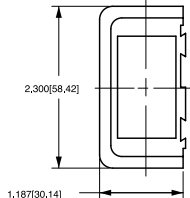

VME
MOUNTING
PANEL
END

VMM
MOUNTING PANEL
MIDDLE

VMS
MOUNTING
PANEL

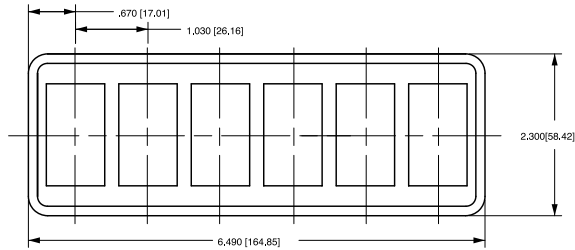
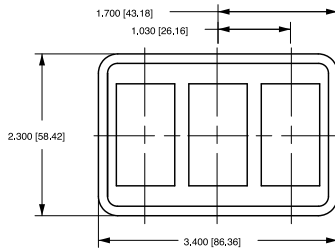

VM3
MOUNTING PANEL

VM6
MOUNTING PANEL

Contura Hole Plug Dimensional Specifications: in. [mm]

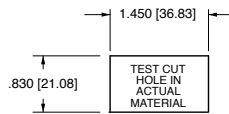

VHP
CONTURA II, III HOLE PLUG

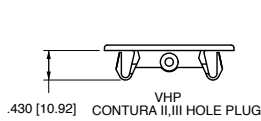

VHP
CONTURA II, III HOLE PLUG

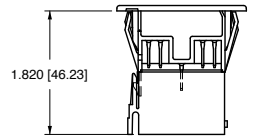

VH1
STANDARD HOLE PLUG
(No wing serrations)
(With VC1 connector attached)

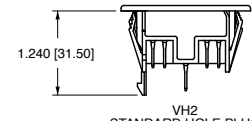

VH2
STANDARD HOLE PLUG
(With wing serrations)

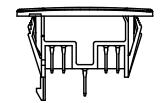
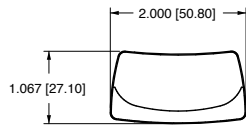

VH3
CONTURA IV HOLE PLUG
(No wing serrations)

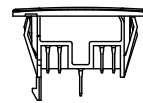

VH4
CONTURA IV HOLE PLUG
(With wing serrations)



DETAIL VIEW
VH1, VH3 & VH5
HOLE PLUGS
(No wing serrations
for ease of removal)

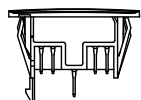

VH5
CONTURA V HOLE PLUG
(No wing serrations)

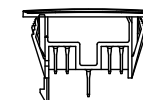

VH6
CONTURA V HOLE PLUG
(With wing serrations)



DETAIL VIEW
VH2, VH4 & VH6
HOLE PLUGS
(With wing serrations)

Authorized Sales Representatives and Distributors

Click on a region of the map below to find your local representatives and distributors or visit www.carlingtech.com/findarep.



About Carling

Founded in 1920, Carling Technologies is a leading manufacturer of electrical and electronic switches and assemblies, circuit breakers, electronic controls, power distribution units, and multiplexed power distribution systems. With four ISO registered manufacturing facilities and technical sales offices worldwide, Carling Technologies Sales, Service and Engineering teams do much more than manufacture electrical components, they engineer powerful solutions! To learn more about Carling please visit www.carlingtech.com/company-profile.

To view all of Carling's environmental, quality, health & safety certifications please visit www.carlingtech.com/environmental-certifications

Worldwide Headquarters

Carling Technologies, Inc.
60 Johnson Avenue, Plainville, CT 06062
Phone: 860.793.9281 **Fax:** 860.793.9231
Email: sales@carlingtech.com

Northern Region Sales Office: nrsm@carlingtech.com
Southeast Region Sales Office: sersm@carlingtech.com
Midwest Region Sales Office: mrrsm@carlingtech.com
West Region Sales Office: wrsm@carlingtech.com
Latin America Sales Office: larsm@carlingtech.com

Asia-Pacific Headquarters

Carling Technologies, Asia-Pacific Ltd.,
Suite 1607, 16/F Tower 2, The Gateway,
Harbour City, 25 Canton Road,
Tsimshatsui, Kowloon, Hong Kong
Phone: Int + 852-2737-2277 **Fax:** Int + 852-2736-9332
Email: sales@carlingtech.com.hk

Shenzhen, China: shenzhen@carlingtech.com
Shanghai, China: shanghai@carlingtech.com
Pune, India: india@carlingtech.com
Kaohsiung, Taiwan: taiwan@carlingtech.com
Yokohama, Japan: japan@carlingtech.com

Europe | Middle East | Africa Headquarters

Carling Technologies LTD
4 Airport Business Park, Exeter Airport,
Clyst Honiton, Exeter, Devon, EX5 2UL, UK
Phone: Int + 44 1392.364422 **Fax:** Int + 44 1392.364477
Email: ltd.sales@carlingtech.com

Germany: gmbh@carlingtech.com
France: sas@carlingtech.com



Carling Technologies®

Innovative Designs. Powerful Solutions.