

VL CONNECTOR

6.2mm pitch/Disconnectable Crimp style connectors

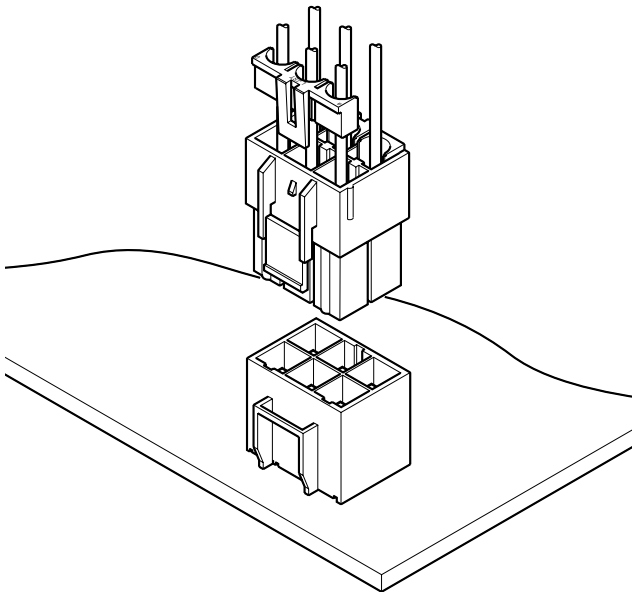

This VL connector is designed for wire-to-wire and wire-to-board 6.2mm pitch connector corresponding to large current. Secondary retainer, which prevents from insufficient insertion of contact and coming off contact, may use and large current circuit can be connected certainly and safety.

- Housing lances for contact retention
- Secondary retainer
- Suited for large current
- Two kinds of connections

Specifications

- Current rating: 20 A AC, DC (Refer to the table below.)
- Voltage rating: 600 V AC, DC
- Temperature range: -25°C to +90°C (including temperature rise in applying electrical current)
- Contact resistance: Initial value/ 7 mΩ max. After environmental tests/ 10 mΩ max.
- Insulation resistance: 1,000 MΩ min.
- Withstanding voltage: 2,000 VAC/minute
- Applicable wire: AWG #22 to #12
- Applicable PC board thickness: 1.6 mm
- * Refer to "General Instruction and Notice when using Terminals and Connectors" at the end of this catalog.
- * Contact JST for details.
- * Compliant with RoHS.

Note: The current rating differs depending on the number of circuits and the wire size used in each connector. The table below lists the current rating as a function of the number of circuits and the wire size.

| Circuits | Wire size(AWG) | | | | | |
|----------|----------------|-----|-----|-----|-----|-----|
| | #12 | #14 | #16 | #18 | #20 | #22 |
| 2 | 20 | 15 | 10 | 8 | 6 | 4 |
| 3 | 17 | 14 | 9 | 8 | 6 | 4 |
| 4 | 16 | 13 | 9 | 7 | 6 | 4 |
| 6 | 15 | 12 | 8 | 7 | 5 | 3 |
| 8 | 14 | 11 | 7 | 6 | 5 | 3 |
| 12 | 13 | 10 | 7 | 6 | 4 | 3 |

Current unit: A

Note: Do not branch in parallel current which exceeds the rated current (e.g. more than 17A in the case of 3 circuits with AWG #12). If branched in parallel, current imbalance or other problems may develop. If it is absolutely necessary to branch such a large current in parallel, design the circuits without causing any imbalance and provide an extra margin for each circuit.

Standards

- UL Recognized E60389
- CS Certified LR20812
- R9351103

PC board layout and Assembly layout

<2, 3, 4 (Single-row) circuits>

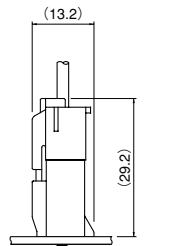
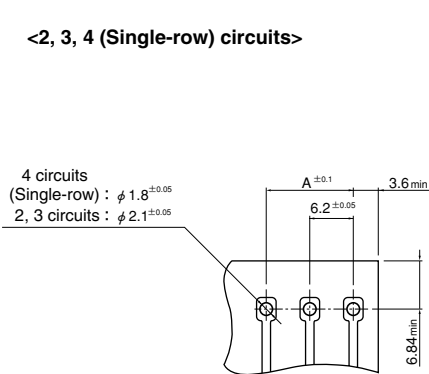

Inner-housing lock

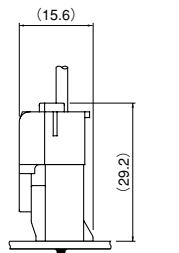

Outer-housing lock

<4, 6, 8, 12 circuits>

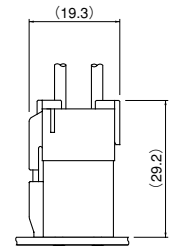
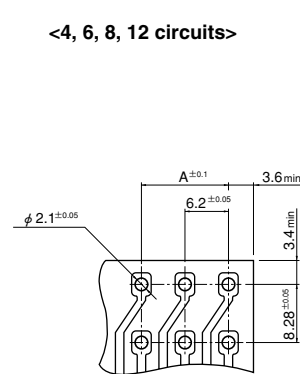

Inner-housing lock

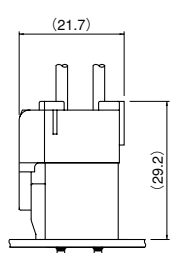

Outer-housing lock

Note: 1. The above figure is the figure viewed from soldering side.

2. Tolerances are non-cumulative: ±0.05 mm for all centers.

3. Hole dimensions differ according to the type of PC board and piercing method. The dimensions above should serve as a guideline. Contact JST for details.

VL CONNECTOR

Contact

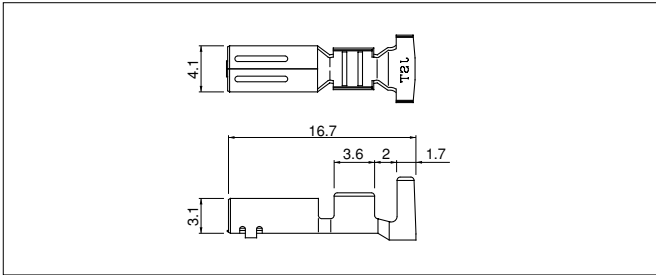

| Model No. | Applicable wire | | Insulation O.D. (mm) | Q'ty/reel |
|----------------------|-----------------|-------|----------------------|-----------|
| | mm ² | AWG # | | |
| *SVF-42T-P2.0 | 0.3~1.25 | 22~16 | 1.7~3.2 | 2,000 |
| SVF-61T-P2.0 | 0.5~2.0 | 20~14 | 1.9~3.4 | 2,000 |
| SVF-81T-P2.0 | 3.5 | 12 | 4.1 | 2,000 |

Material and Finish

Phosphor bronze, tin-plated (reflow treatment)

RoHS compliance

Note: *Marked product is not TÜV approved.

| Contact | Crimping machine | Applicator | | |
|---------------------|------------------|------------------|----------------|----------------------------|
| | | Crimp applicator | Dies | Crimp applicator with dies |
| SVF-42T-P2.0 | AP-K2N | MKS-L | MK/SVF/M-42-20 | APLMK SVF/M42-20 |
| SVF-61T-P2.0 | | MKS-L | MK/SVF/M-61-20 | APLMK SVF/M61-20 |

| Contact | Crimping machine | Applicator | | |
|---------------------|------------------|------------------|----------------|----------------------------|
| | | Crimp applicator | Dies | Crimp applicator with dies |
| SVF-81T-P2.0 | AP-K2N | MKS-L | MK/SVF/M-81-20 | APLMK SVF/M81-20 |

Housing (Inner-housing lock)

<2 circuits>

<3 circuits>

<4 circuits>

<6 circuits>

<8 circuits>

<12 circuits>

| Circuits | Model No. | Q'ty/bag |
|----------|----------------|----------|
| 2 | VLP-02V | 500 |
| 3 | VLP-03V | 500 |
| 4 | VLP-04V | 500 |
| 6 | VLP-06V | 500 |
| 8 | VLP-08V | 200 |
| 12 | VLP-12V | 100 |

Material

PA 66, UL94V-0, natural (white)

RoHS compliance

VL CONNECTOR

Housing (Outer-housing lock)



| Circuits | Model No. | Q'ty/bag |
|-----------------|-------------------|----------|
| 2 | VLP-02V-1 | 500 |
| 3 | VLP-03V-1 | 500 |
| 4 | VLP-04V-1 | 500 |
| 4(single-row) | VLP-04VN-1 | 500 |
| 6 | VLP-06V-1 | 500 |
| 8 | VLP-08V-1 | 200 |
| 12 | VLP-12V-1 | 100 |
| Material | | |

PA 66, UL94V-0, natural (white)

RoHS compliance

VL CONNECTOR

Retainer

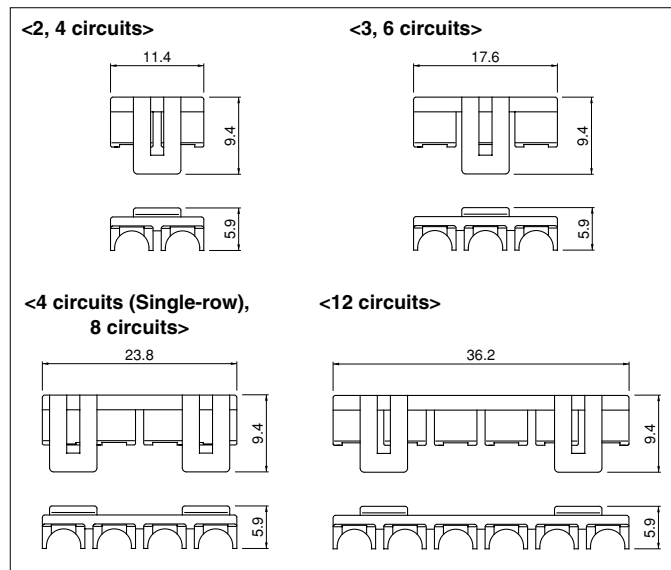

| Circuits | Model No. | Q'ty/bag |
|-------------------|----------------|----------|
| 2, 4 | VLS-02V | 1,000 |
| 3, 6 | VLS-03V | 1,000 |
| 4 (single-row), 8 | VLS-08V | 1,000 |
| 12 | VLS-12V | 1,000 |

Material

Glass-filled PA 66, UL94V-0, natural (ivory)

RoHS compliance

Shrouded header

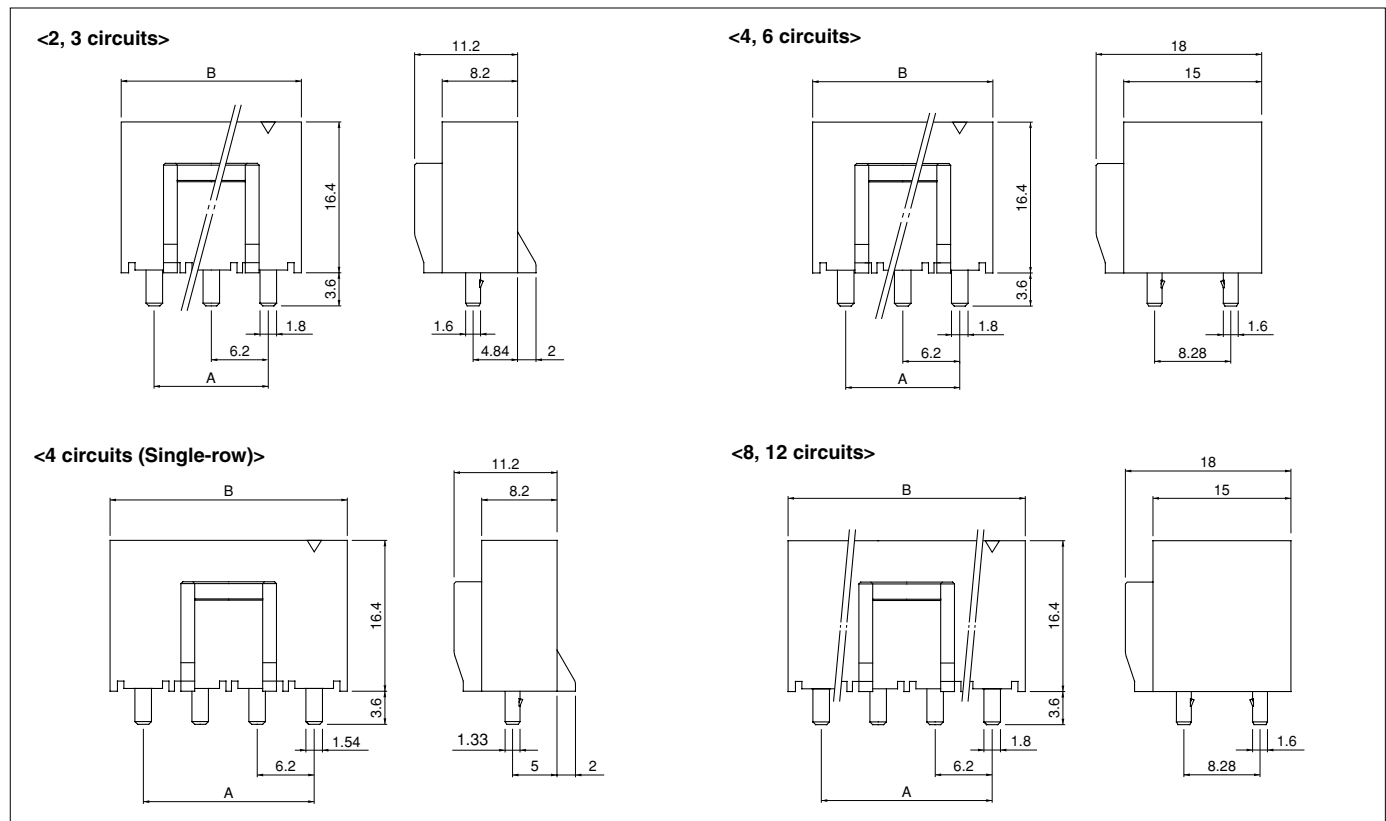

| Circuits | Model No. | Dimensions (mm) | | Q'ty/box |
|----------------|-----------------------|-----------------|------|----------|
| | | A | B | |
| 2 | B02P-VL | 6.2 | 13.4 | 100 |
| 3 | B03P-VL | 12.4 | 19.6 | 100 |
| 4 | B04P-VL | 6.2 | 13.4 | 100 |
| 4 (single-row) | B04P-VL-VN-1.8 | 18.6 | 26.2 | 100 |
| 6 | B06P-VL | 12.4 | 19.6 | 50 |
| 8 | B08P-VL | 18.6 | 26.2 | 50 |
| 12 | B12P-VL | 31.0 | 38.6 | 35 |

Material and Finish

Post: Copper-alloy, tin-plated (reflow treatment)
Wafer: PA 66, UL94V-0, natural (white)

RoHS compliance

Contact position location numbers

Inner-housing lock

<2 circuits>

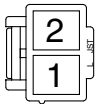

<3 circuits>

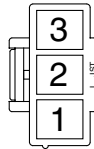

<4 circuits>

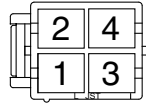

<6 circuits>

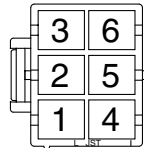

<8 circuits>

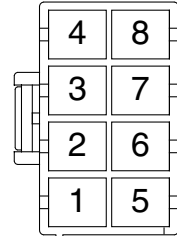

<12 circuits>

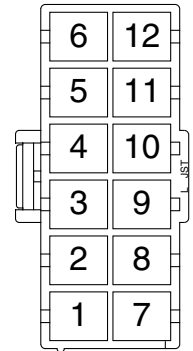

Outer-housing lock

<2 circuits>

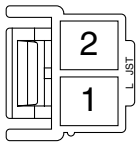

<3 circuits>

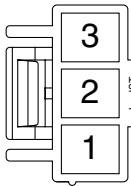

<4 circuits>

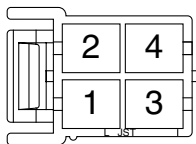

<4 circuits
(Single-row)>

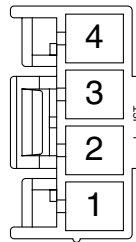

<6 circuits>

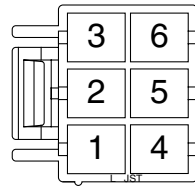

<8 circuits>

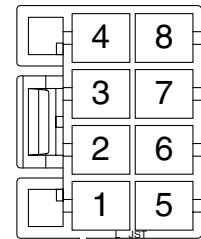

<12 circuits>

