

## GaAs MMIC VOLTAGE-VARIABLE ATTENUATOR, 5 - 30 GHz

### Typical Applications

The HMC812ALC4 is ideal for:

- Point-to-Point Radio
- VSAT Radio
- Test Instrumentation
- Microwave Sensors
- Military, ECM & Radar

### Functional Diagram

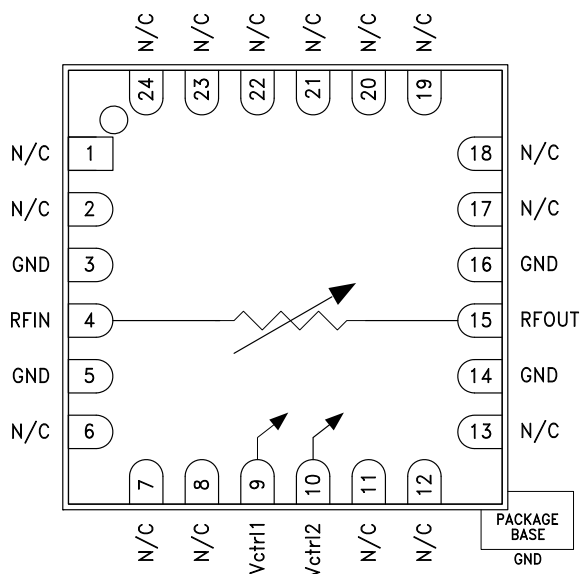

### Features

- Wide Bandwidth: 5 - 30 GHz
- High Power Handling: +25 dBm Input P1dB
- Excellent Linearity: +28 dBm Input IP3
- Wide Attenuation Range: 30 dB
- 24 Lead Ceramic 4x4 mm SMT Package: 16mm<sup>2</sup>

### General Description

The HMC812ALC4 is an absorptive Voltage Variable Attenuator (VVA) which operates from 5 - 30 GHz and is ideal in designs where an analog DC control signal must be used to control RF signal levels over a 30 dB amplitude range. It features two shunt-type attenuators which are controlled by two analog voltages, Vctrl1 and Vctrl2. Optimum linearity performance of the attenuator is achieved by first varying Vctrl1 of the 1st attenuation stage from -5V to 0V with Vctrl2 fixed at -5V. The control voltage of the 2nd attenuation stage, Vctrl2, should then be varied from -5V to 0V, with Vctrl1 fixed at 0V. The HMC812ALC4 is housed in a RoHS compliant 4x4 mm QFN leadless ceramic package

Furthermore, if the Vctrl1 and Vctrl2 pins are connected together it is possible to achieve the full analog attenuation range with only a small degradation in input IP3 performance. Applications include AGC circuits and temperature compensation of multiple gain stages in microwave point-to-point and VSAT radios.

### Electrical Specifications, $T_A = +25^\circ C$ , 50 Ohm system

Parameter	Min.	Typ.	Max.	Units
Insertion Loss		1.8		dB
	5 - 16 GHz			dB
	16 - 24 GHz			dB
		2.2		dB
		2.5		dB
Attenuation Range		35		dB
Input Return Loss		10		dB
Output Return Loss		10		dB
Input Power for 1 dB Compression (any attenuation)		25		dBm
Input Third Order Intercept (Two-tone Input Power = 10 dBm Each Tone)		28		dBm

Information furnished by Analog Devices is believed to be accurate and reliable. However, no responsibility is assumed by Analog Devices for its use, nor for any infringements of patents or other rights of third parties that may result from its use. Specifications subject to change without notice. No license is granted by implication or otherwise under any patent or patent rights of Analog Devices. Trademarks and registered trademarks are the property of their respective owners.

For price, delivery, and to place orders: Analog Devices, Inc., One Technology Way, P.O. Box 9106, Norwood, MA 02062-9106 Phone: 781-329-4700 • Order online at [www.analog.com](http://www.analog.com) Application Support: Phone: 1-800-ANALOG-D

# HMC812A\* PRODUCT PAGE QUICK LINKS

Last Content Update: 07/01/2017

---

## COMPARABLE PARTS

View a parametric search of comparable parts.

## EVALUATION KITS

- Evaluation board for the HMC812A.

## DOCUMENTATION

### Data Sheet

- HMC812ALC4: GaAs MMIC Voltage-Variable Attenuator, 5 - 30 GHz Data Sheet

## TOOLS AND SIMULATIONS

- HMC812A S-Parameters

## DESIGN RESOURCES

- hmc812a Material Declaration
- PCN-PDN Information
- Quality And Reliability
- Symbols and Footprints

## DISCUSSIONS

View all hmc812a EngineerZone Discussions.

## SAMPLE AND BUY

Visit the product page to see pricing options.

## TECHNICAL SUPPORT

Submit a technical question or find your regional support number.

## DOCUMENT FEEDBACK

Submit feedback for this data sheet.

---

**GaAs MMIC VOLTAGE-VARIABLE ATTENUATOR, 5 - 30 GHz**

**Attenuation vs. Frequency over Vctrl**  
Vctrl1 = Variable, Vctrl2 = -5V

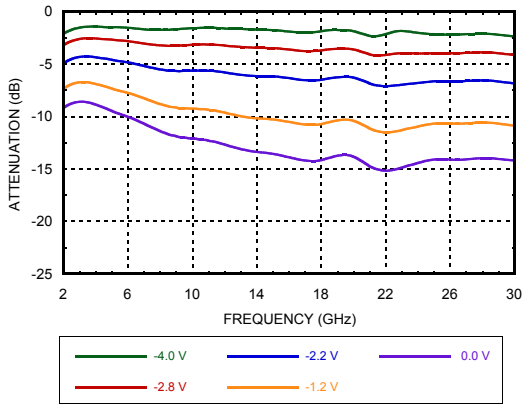

**Attenuation vs. Frequency over Vctrl**  
Vctrl1 = 0V, Vctrl2 = Variable

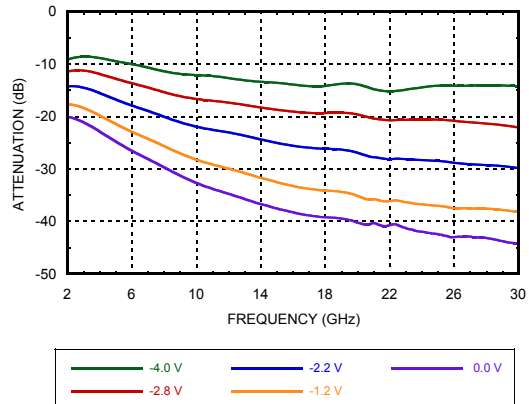

**Attenuation vs. Vctrl1**  
Over Temperature @ 10 GHz, Vctrl2 = -5V

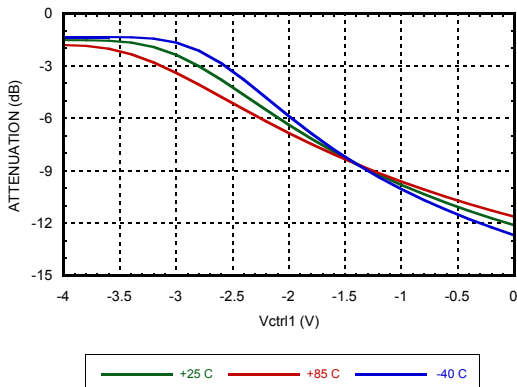

**Attenuation vs. Vctrl2**  
Over Temperature @ 10 GHz, Vctrl1 = 0V

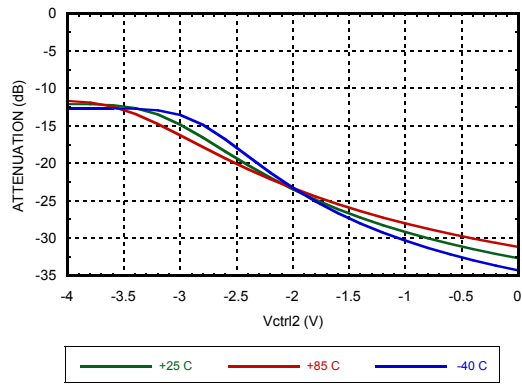

**Attenuation vs. Pin @ 10 GHz**  
Vctrl1 = Variable, Vctrl2 = -5V

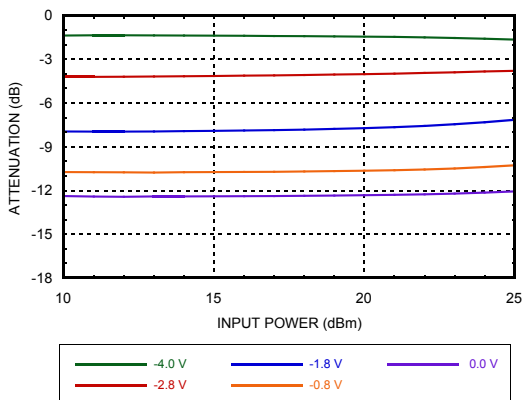

**Input Return Loss**  
Vctrl1 = Variable, Vctrl2 = -5V

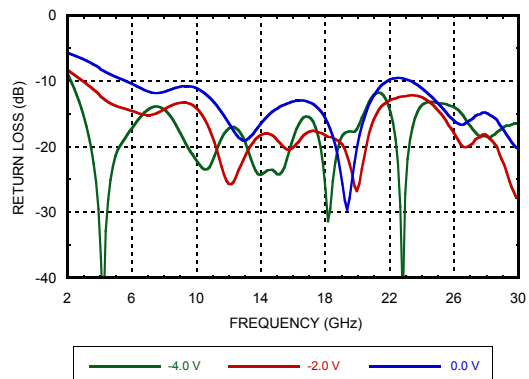

**GaAs MMIC VOLTAGE-VARIABLE ATTENUATOR, 5 - 30 GHz**

**Input Return Loss**  
*Vctrl1 = 0V, Vctrl2 = Variable*

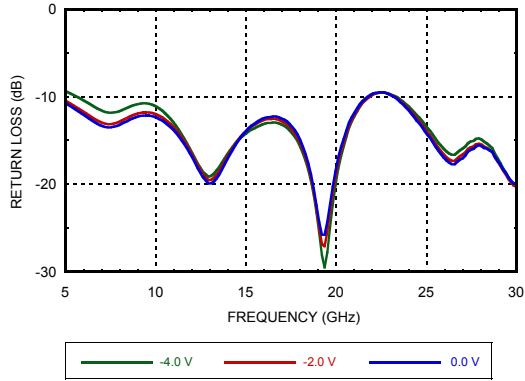

**Output Return Loss**  
*Vctrl1 = Variable, Vctrl2 = -5V*

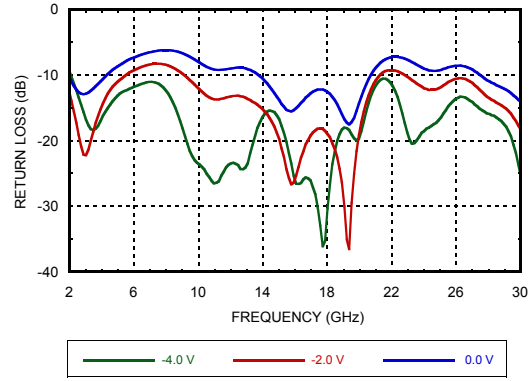

**Output Return Loss**  
*Vctrl1 = 0V, Vctrl2 = Variable*

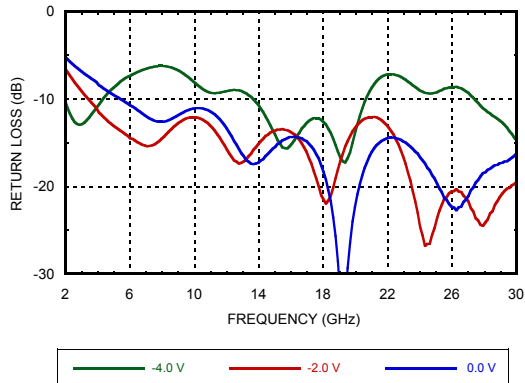

**Input IP3 vs Input Power @ 10 GHz**  
*Vctrl1 = Variable, Vctrl2 = -5V*

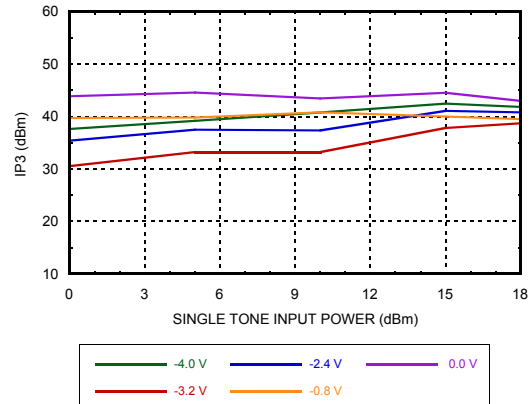

**Input IP3 vs. Input Power Over Frequency**  
*Vctrl1 = -3.2V, Vctrl2 = -5V (Worst Case IP3)*

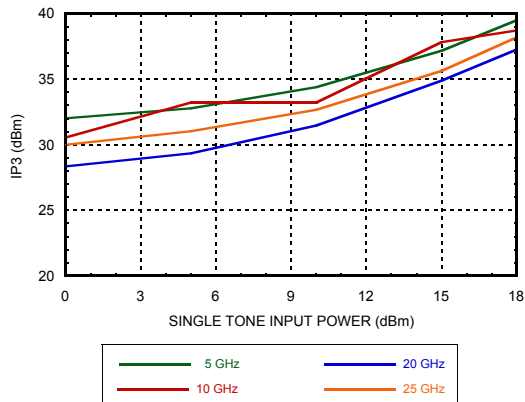

**Input IP3 vs. Input Power Over Temperature @ 10 GHz**  
*Vctrl1 = -3.2V, Vctrl2 = -5V*

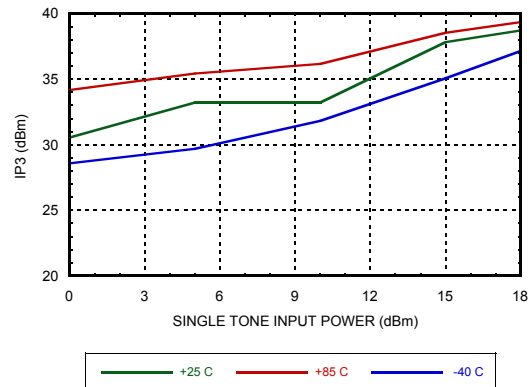

**GaAs MMIC VOLTAGE-VARIABLE ATTENUATOR, 5 - 30 GHz**

**Attenuation vs. Frequency over Vctrl**  
Vctrl1 = Vctrl2

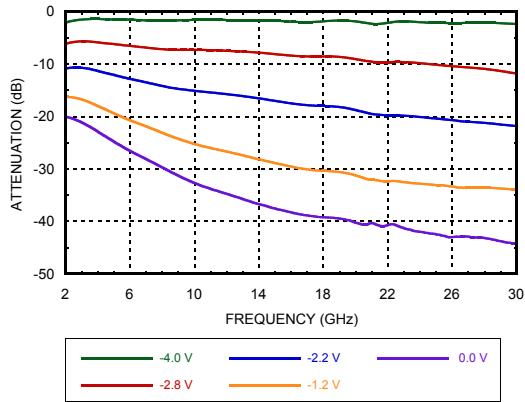

**Attenuation vs. Vctrl over Temperature**  
@ 10 GHz, Vctrl1 = Vctrl2

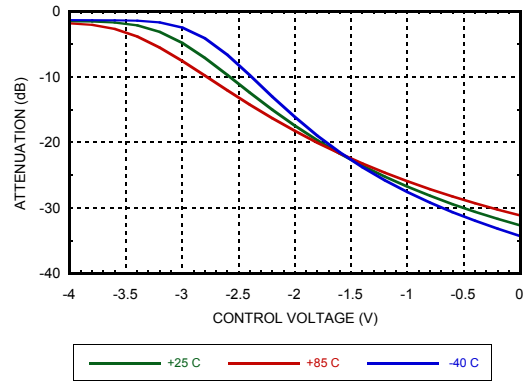

**Attenuation vs. Input Power over Vctrl**  
Vctrl1 = Vctrl2

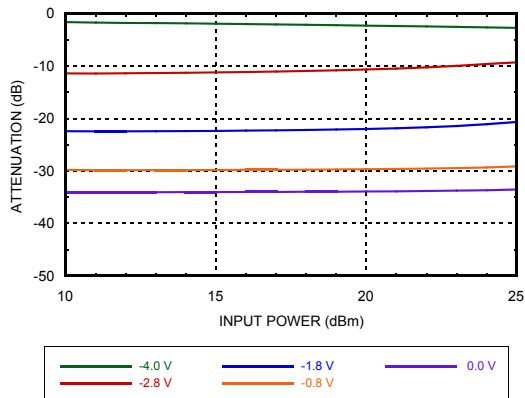

**Input Return Loss, Vctrl1 = Vctrl2**

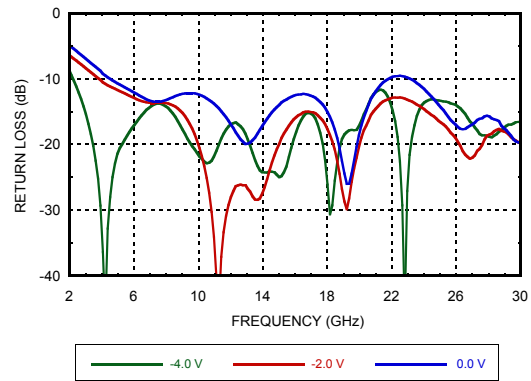

**Output Return Loss, Vctrl1 = Vctrl2**

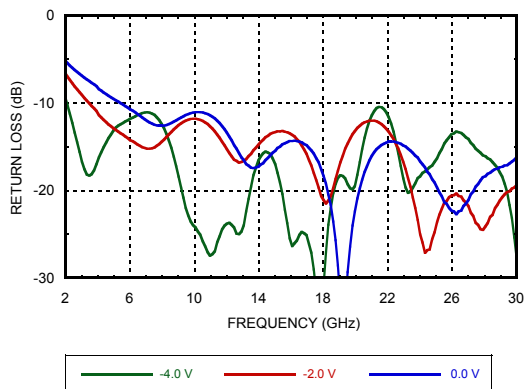

**Input IP3 vs. Input Power Over Vctrl @ 10 GHz, Vctrl1 = Vctrl2**

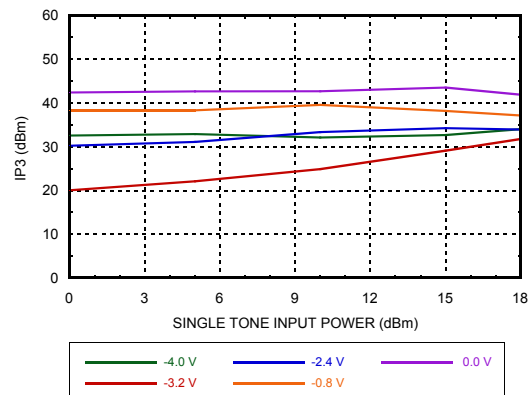

## GaAs MMIC VOLTAGE-VARIABLE ATTENUATOR, 5 - 30 GHz

### Absolute Maximum Ratings

RF Input Power	+30 dBm
Control Voltage Range	+0.3 to -6V
Channel Temperature	175 °C
Continuous Pdiss (T = 85 °C) (derate 16.4 mW/°C above 85 °C)	1.07 W
Thermal Resistance (Channel to ground paddle)	61 °C/W
Storage Temperature	-65 to +150 °C
Operating Temperature	-40 to +85 °C
ESD Sensitivity (HBM)	Class 0 (Passed 150V)

### Control Voltages

Vctrl1	-5 to 0V @ 10 µA
Vctrl2	-5 to 0V @ 10 µA



ELECTROSTATIC SENSITIVE DEVICE  
OBSERVE HANDLING PRECAUTIONS

### Outline Drawing

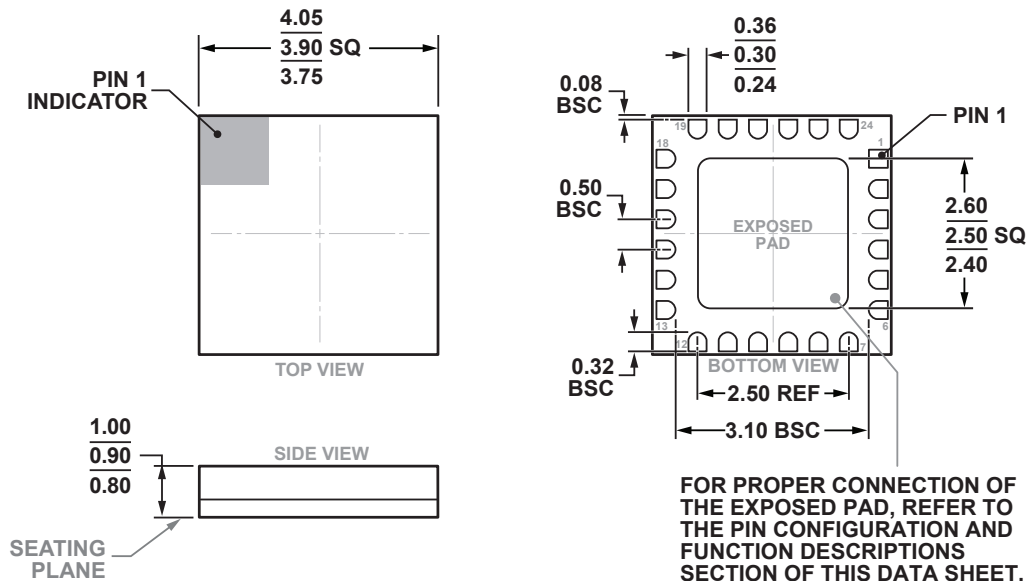

24-Terminal Ceramic Leadless Chip Carrier [LCC]  
(E-24-1)  
Dimensions shown in millimeters

### Package Information

Part Number	Package Body Material	Lead Finish	MSL Rating	Package Marking
HMC812ALC4	Alumina, White	Gold over Nickel	MSL3	812A XXXX

## GaAs MMIC VOLTAGE-VARIABLE ATTENUATOR, 5 - 30 GHz

### Pin Descriptions

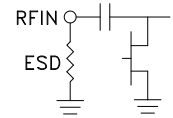
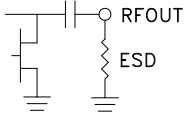
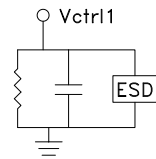
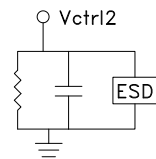
Pin Number	Function	Description	Interface Schematic
1, 2, 6 - 8, 11 - 13, 17 - 24	N/C	These pins are not connected internally, however these pins must be connected to RF/DC ground externally.	
3, 5, 14, 16	GND	These pins and the exposed ground paddle must be connected to RF/DC ground.	
4	RFIN	This pad is DC coupled and matched to 50 Ohms. A blocking capacitor is required if RF line potential is not equal to 0V.	
15	RFOUT		
9	Vctrl1	Control Voltage 1	
10	Vctrl2	Control Voltage 2	

**GaAs MMIC VOLTAGE-VARIABLE  
ATTENUATOR, 5 - 30 GHz**

**Application Circuit**

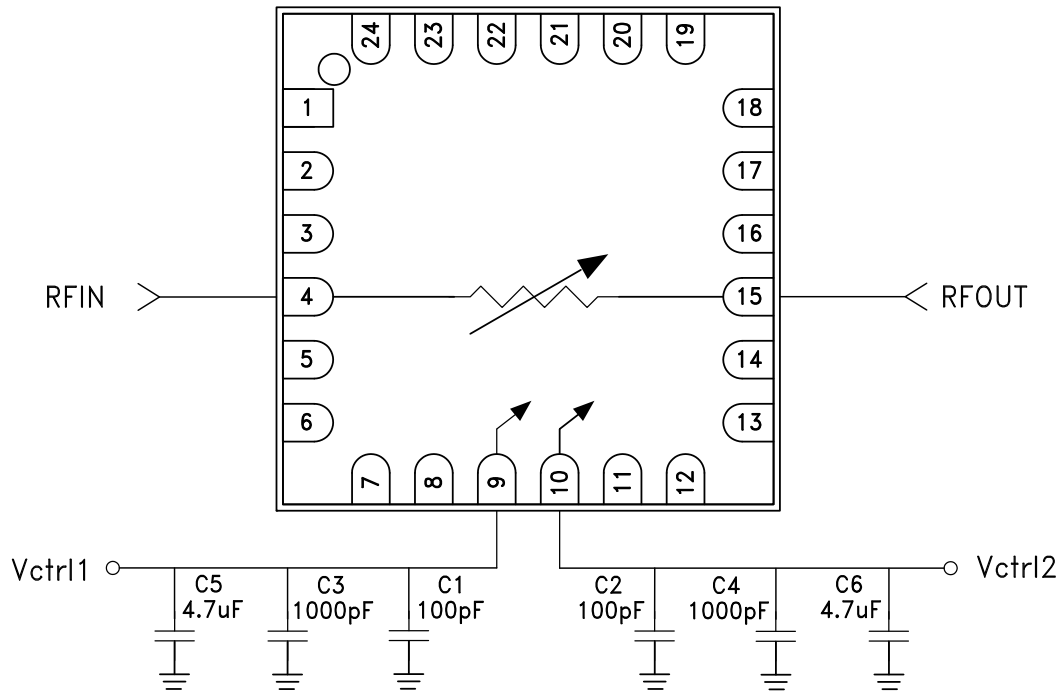

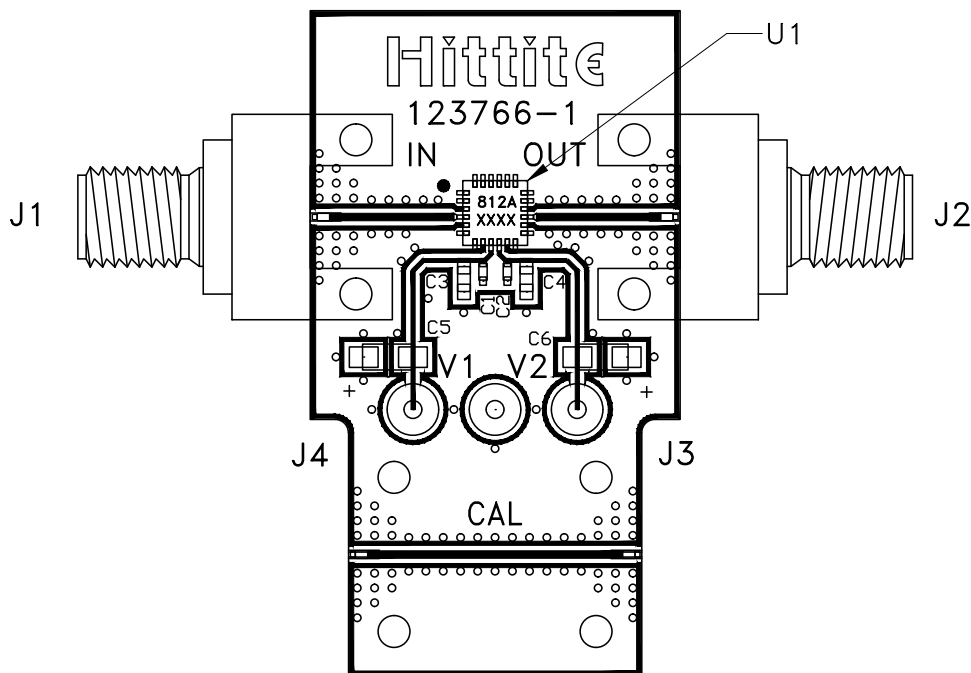

**GaAs MMIC VOLTAGE-VARIABLE  
ATTENUATOR, 5 - 30 GHz**
**Evaluation PCB**

**List of Materials for EV1HMC812ALC4 [1]**

Item	Description
J1, J2	2.9 mm PC Mount RF Connector
J3, J4	DC Pin
C1, C2	100 pF Capacitor, 0402 Pkg.
C3, C4	1000 pF Capacitor, 0402 Pkg.
C5, C6	4.7 $\mu$ F Capacitor, CASE A
U1	HMC812ALC4 Analog VVA
PCB [2]	123766 Evaluation PCB

[1] Reference this number when ordering complete evaluation PCB

[2] Circuit Board Material: Arlon 25FR or Rogers 4350

The circuit board used in the final application should use RF circuit design techniques. Signal lines should have 50 Ohm impedance while the package ground leads and exposed paddle should be connected directly to the ground plane similar to that shown. A sufficient number of via holes should be used to connect the top and bottom ground planes. The evaluation circuit board shown is available from Analog Devices upon request.