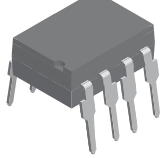
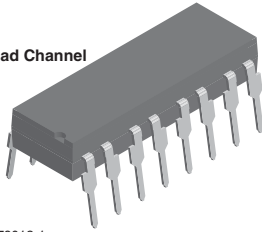


## Optocoupler, Phototransistor Output (Dual, Quad Channel)

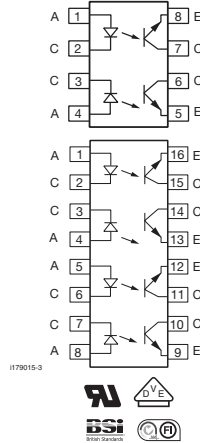
Dual Channel



Quad Channel



i179012-1



### FEATURES

- Current transfer ratio at  $I_F = 10 \text{ mA}$
- Isolation test voltage,  $5300 \text{ V}_{\text{RMS}}$
- Compliant to RoHS Directive 2002/95/EC and in accordance to WEEE 2002/96/EC



**RoHS**  
COMPLIANT

### AGENCY APPROVALS

- UL1577, file no. E52744 system code H, double protection
- CSA 93751
- BSI IEC 60950; IEC 60065
- DIN EN 60747-5-2 (VDE 0884) available with option 1
- FIMKO

### DESCRIPTION

The ILD1, ILD2, ILD5, ILQ1, ILQ2, ILQ5 are optically coupled isolated pairs employing GaAs infrared LEDs and silicon NPN phototransistor. Signal information, including a DC level, can be transmitted by the drive while maintaining a high degree of electrical isolation between input and output.

The ILD1, ILD2, ILD5, ILQ1, ILQ2, ILQ5 are especially designed for driving medium-speed logic and can be used to eliminate troublesome ground loop and noise problems. Also these couplers can be used to replace relays and transformers in many digital interface applications such as CTR modulation.

The ILD1, ILD2, ILD5 has two isolated channels in a single DIP package and the ILQ1, ILQ2, ILQ5 has four isolated channels per package.

ORDERING INFORMATION						
<div style="display: flex; justify-content: space-around; align-items: center;"> <div style="border: 1px solid black; padding: 2px;">I</div> <div style="border: 1px solid black; padding: 2px;">L</div> <div style="border: 1px solid black; padding: 2px;">x</div> <div style="border: 1px solid black; padding: 2px;">#</div> <div style="border: 1px solid black; padding: 2px;">-</div> <div style="border: 1px solid black; padding: 2px;">X</div> <div style="border: 1px solid black; padding: 2px;">0</div> <div style="border: 1px solid black; padding: 2px;">#</div> <div style="border: 1px solid black; padding: 2px;">#</div> <div style="border: 1px solid black; padding: 2px;">T</div> </div> <p style="text-align: center;">PART NUMBER</p> <p style="text-align: center;">x = D (Dual) or Q (Quad)</p> <p style="text-align: center;">PACKAGE OPTION</p> <p style="text-align: center;">TAPE AND REEL</p>	<p>7.62 mm</p>	<p>10.16 mm</p>	<p>&gt; 0.7 mm</p>	<p>&gt; 0.1 mm</p>		
AGENCY CERTIFIED/PACKAGE	DUAL CHANNEL			QUAD CHANNEL		
	CTR (%)					
UL, CSA, BSI, FIMKO	20 to 300	100 to 500	50 to 400	20 to 300	100 to 500	50 to 400
DIP-8	ILD1	ILD2	ILD5	-	-	-
DIP-8, 400 mil, option 6	-	ILD2-X006	-	-	-	-
SMD-8, option 7	ILD1-X007T <sup>(1)</sup>	ILD2-X007T <sup>(1)</sup>	-	-	-	-
SMD-8, option 9	ILD1-X009T <sup>(1)</sup>	ILD2-X009T <sup>(1)</sup>	ILD5-X009T <sup>(1)</sup>	-	-	-
DIP-16	-	-	-	ILQ1	ILQ2	ILQ5
DIP-16, 400 mil, option 6	-	-	-	ILQ1-X006	ILQ2-X006	-
SMD-16, option 7	-	-	-	ILQ1-X007	ILQ2-X007T <sup>(1)</sup>	-
SMD-16, option 9	-	-	-	ILQ1-X009T <sup>(1)</sup>	ILQ2-X009T <sup>(1)</sup>	ILQ5-X009T <sup>(1)</sup>



AGENCY CERTIFIED/PACKAGE	DUAL CHANNEL			QUAD CHANNEL		
	CTR (%)					
VDE, UL, CSA, BSI, FIMKO	20 to 300	100 to 500	50 to 400	20 to 300	100 to 500	50 to 400
DIP-8	ILD1-X001	ILD2-X001	ILD5-X001	-	-	-
DIP-8, 400 mil, option 6	-	ILD2-X016	-	-	-	-
SMD-8, option 7	-	ILD2-X017	-	-	-	-
SMD-8, option 9	ILD1-X019T	-	-	-	-	-
DIP-16	-	-	-	-	ILQ2-X001	-
DIP-16, 400 mil, option 6	-	-	-	-	ILQ2-X016	-
SMD-16, option 7	-	-	-	-	ILQ2-X017T <sup>(1)</sup>	-

**Notes**

- Additional options may be possible, please contact sales office.
- <sup>(1)</sup> Also available in tubes; do not put T on end.

ABSOLUTE MAXIMUM RATINGS (T <sub>amb</sub> = 25 °C, unless otherwise specified)					
PARAMETER	TEST CONDITION	PART	SYMBOL	VALUE	UNIT
<b>INPUT</b>					
Reverse voltage			V <sub>R</sub>	6	V
Forward current			I <sub>F</sub>	60	mA
Surge current			I <sub>FSM</sub>	2.5	A
Power dissipation			P <sub>diss</sub>	100	mW
Derate linearly from 25 °C				1.3	mW/°C
<b>OUTPUT</b>					
Collector emitter reverse voltage		ILD1	V <sub>CEO</sub>	50	V
		ILQ1	V <sub>CEO</sub>	50	V
		ILD2	V <sub>CEO</sub>	70	V
		ILQ2	V <sub>CEO</sub>	70	V
		ILD5	V <sub>CEO</sub>	70	V
		ILQ5	V <sub>CEO</sub>	70	V
Collector current			I <sub>C</sub>	50	mA
	t < 1 ms		I <sub>C</sub>	400	mA
Power dissipation			P <sub>diss</sub>	200	mW
Derate linearly from 25 °C				2.6	mW/°C
<b>COUPLER</b>					
Isolation test voltage between emitter and detector			V <sub>ISO</sub>	5300	V <sub>RMS</sub>
Creepage distance				≥ 7	mm
Clearance distance				≥ 7	mm
Isolation resistance	V <sub>IO</sub> = 500 V, T <sub>amb</sub> = 25 °C		R <sub>IO</sub>	≥ 10 <sup>12</sup>	Ω
	V <sub>IO</sub> = 500 V, T <sub>amb</sub> = 100 °C		R <sub>IO</sub>	≥ 10 <sup>11</sup>	
Package power dissipation			P <sub>tot</sub>	250	mW
Derate linearly from 25 °C				3.3	mW/°C
Storage temperature			T <sub>stg</sub>	- 40 to + 150	°C
Operating temperature			T <sub>amb</sub>	- 40 to + 100	°C
Junction temperature			T <sub>j</sub>	100	°C
Soldering temperature <sup>(2)</sup>	2 mm from case bottom		T <sub>slid</sub>	260	°C

**Notes**

- Stresses in excess of the absolute maximum ratings can cause permanent damage to the device. Functional operation of the device is not implied at these or any other conditions in excess of those given in the operational sections of this document. Exposure to absolute maximum ratings for extended periods of the time can adversely affect reliability.
- <sup>(1)</sup> Refer to reflow profile for soldering conditions for surface mounted devices (SMD). Refer to wave profile for soldering conditions for through hole devices (DIP).



<b>ELECTRICAL CHARACTERISTICS</b> ( $T_{amb} = 25\text{ }^{\circ}\text{C}$ , unless otherwise specified)						
PARAMETER	TEST CONDITION	SYMBOL	MIN.	TYP.	MAX.	UNIT
<b>INPUT</b>						
Forward voltage	$I_F = 60\text{ mA}$	$V_F$		1.25	1.65	V
Reverse current	$V_R = 6\text{ V}$	$I_R$		0.01	10	$\mu\text{A}$
Capacitance	$V_R = 0\text{ V}$ , $f = 1\text{ MHz}$	$C_O$		25		pF
Thermal resistance, junction to lead		$T_{thJL}$		750		K/W
<b>OUTPUT</b>						
Collector emitter capacitance	$V_{CE} = 5\text{ V}$ , $f = 1\text{ MHz}$	$C_{CE}$		6.8		pF
Collector emitter leakage current	$V_{VCE} = 10\text{ V}$	$I_{CEO}$		5	50	nA
Saturation voltage, collector emitter	$I_C = 1\text{ mA}$ , $I_B = 20\text{ }\mu\text{A}$	$V_{CESAT}$		0.25	0.4	V
DC forward current gain	$V_{CE} = 10\text{ V}$ , $I_B = 20\text{ }\mu\text{A}$	$h_{FE}$	200	650	1800	
DC forward current gain saturated	$V_{CE} = 0.4\text{ V}$ , $I_B = 20\text{ }\mu\text{A}$	$h_{FEsat}$	120	400	600	
Thermal resistance, junction to lead		$R_{thjL}$		500		K/W
<b>COUPLER</b>						
Capacitance (input to output)	$V_{IO} = 0\text{ V}$ , $f = 1\text{ MHz}$	$C_{IO}$		0.8		pF

**Note**

- Minimum and maximum values are testing requirements. Typical values are characteristics of the device and are the result of engineering evaluation. Typical values are for information only and are not part of the testing requirements.

<b>CURRENT TRANSFER RATIO</b> ( $T_{amb} = 25\text{ }^{\circ}\text{C}$ , unless otherwise specified)							
PARAMETER	TEST CONDITION	PART	SYMBOL	MIN.	TYP.	MAX.	UNIT
$I_C/I_F$ (collector emitter saturated)	$I_F = 10\text{ mA}$ , $V_{CE} = 0.4\text{ V}$	ILD1	$CTR_{CEsat}$		75		%
		ILQ1	$CTR_{CEsat}$		75		%
		ILD2	$CTR_{CEsat}$		170		%
		ILQ2	$CTR_{CEsat}$		170		%
		ILD5	$CTR_{CEsat}$		100		%
		ILQ5	$CTR_{CEsat}$		100		%
	$I_F = 10\text{ mA}$ , $V_{CE} = 10\text{ V}$	ILD1	$CTR_{CE}$	20	80	300	%
		ILQ1	$CTR_{CE}$	20	80	300	%
		ILD2	$CTR_{CE}$	100	200	500	%
		ILQ2	$CTR_{CE}$	100	200	500	%
		ILD5	$CTR_{CE}$	50	130	400	%
		ILQ5	$CTR_{CE}$	50	130	400	%

SAFETY AND INSULATION RATINGS						
PARAMETER	TEST CONDITION	SYMBOL	MIN.	TYP.	MAX.	UNIT
Isolation test voltage between emitter and detector		$V_{ISO}$	5300			$V_{RMS}$
Isolation resistance	$V_{IO} = 500\text{ V}, T_{amb} = 25\text{ °C}$	$R_{IO}$	$10^{12}$			$\Omega$
	$V_{IO} = 500\text{ V}, T_{amb} = 100\text{ °C}$		$10^{11}$			
Climatic classification (according to IEC 68 part 1)				55/100/21		
Comparative tracking index		CTI	175			
Rated impulse voltage		$V_{IOTM}$			10	kV
Maximum working voltage	Recurring peak voltage	$V_{IORM}$			890	V
Forward current		$I_{SI}$			275	mA
Power dissipation		$P_{SO}$			400	mW
Safety temperature		$T_{SI}$			175	°C
Creepage distance			7.0			mm
Clearance distance			7.0			mm
Insulation distance	per IEC 60950 2.10.5.1		0.4			mm

**Note**

- According to DIN EN 60747-5-2 (VDE 0884) (see figure 2). These optocouplers are suitable for “safety electrical insulation” only within the safety ratings. Compliance with the safety ratings shall be ensured by means of suitable protective circuits.

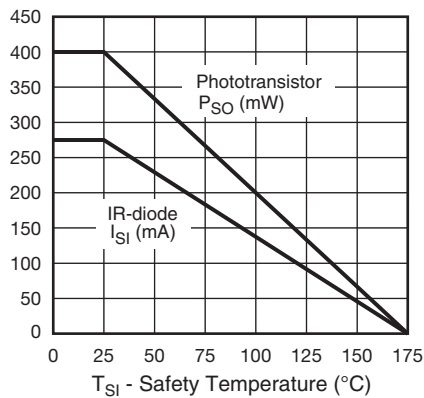


Fig. 1 - Derating Diagram

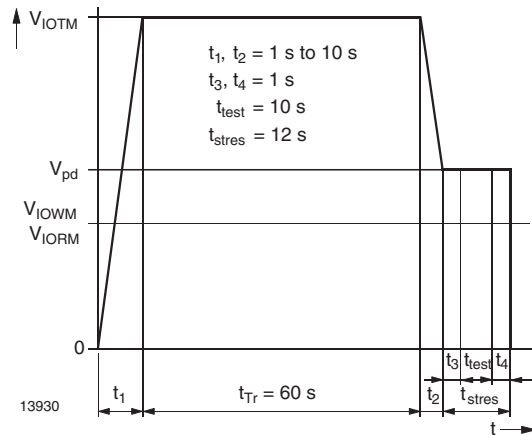


Fig. 2 - Test Pulse Diagram for Sample Test according to DIN EN 60747-5-2 (VDE 0884); IEC 60747-5-5



SWITCHING CHARACTERISTICS (T <sub>amb</sub> = 25 °C, unless otherwise specified)							
PARAMETER	TEST CONDITION	PART	SYMBOL	MIN.	TYP.	MAX.	UNIT
<b>NON-SATURATED</b>							
Current	V <sub>CE</sub> = 5 V, R <sub>L</sub> = 75 Ω, 50 % of V <sub>PP</sub>	ILD1	I <sub>F</sub>		20		mA
		ILQ1	I <sub>F</sub>		20		mA
		ILD2	I <sub>F</sub>		5		mA
		ILQ2	I <sub>F</sub>		5		mA
		ILD5	I <sub>F</sub>		10		mA
		ILQ5	I <sub>F</sub>		10		mA
Delay	V <sub>CE</sub> = 5 V, R <sub>L</sub> = 75 Ω, 50 % of V <sub>PP</sub>	ILD1	t <sub>D</sub>		0.8		μs
		ILQ1	t <sub>D</sub>		0.8		μs
		ILD2	t <sub>D</sub>		1.7		μs
		ILQ2	t <sub>D</sub>		1.7		μs
		ILD5	t <sub>D</sub>		1.7		μs
		ILQ5	t <sub>D</sub>		1.7		μs
Rise time	V <sub>CE</sub> = 5 V, R <sub>L</sub> = 75 Ω, 50 % of V <sub>PP</sub>	ILD1	t <sub>r</sub>		1.9		μs
		ILQ1	t <sub>r</sub>		1.9		μs
		ILD2	t <sub>r</sub>		2.6		μs
		ILQ2	t <sub>r</sub>		2.6		μs
		ILD5	t <sub>r</sub>		2.6		μs
		ILQ5	t <sub>r</sub>		2.6		μs
Storage	V <sub>CE</sub> = 5 V, R <sub>L</sub> = 75 Ω, 50 % of V <sub>PP</sub>	ILD1	t <sub>s</sub>		0.2		μs
		ILQ1	t <sub>s</sub>		0.2		μs
		ILD2	t <sub>s</sub>		0.4		μs
		ILQ2	t <sub>s</sub>		0.4		μs
		ILD5	t <sub>s</sub>		0.4		μs
		ILQ5	t <sub>s</sub>		0.4		μs
Fall time	V <sub>CE</sub> = 5 V, R <sub>L</sub> = 75 Ω, 50 % of V <sub>PP</sub>	ILD1	t <sub>f</sub>		1.4		μs
		ILQ1	t <sub>f</sub>		1.4		μs
		ILD2	t <sub>f</sub>		2.2		μs
		ILQ2	t <sub>f</sub>		2.2		μs
		ILD5	t <sub>f</sub>		2.2		μs
		ILQ5	t <sub>f</sub>		2.2		μs
Propagation H to L	V <sub>CE</sub> = 5 V, R <sub>L</sub> = 75 Ω, 50 % of V <sub>PP</sub>	ILD1	t <sub>PHL</sub>		0.7		μs
		ILQ1	t <sub>PHL</sub>		0.7		μs
		ILD2	t <sub>PHL</sub>		1.2		μs
		ILQ2	t <sub>PHL</sub>		1.2		μs
		ILD5	t <sub>PHL</sub>		1.1		μs
		ILQ5	t <sub>PHL</sub>		1.1		μs
Propagation L to H	V <sub>CE</sub> = 5 V, R <sub>L</sub> = 75 Ω, 50 % of V <sub>PP</sub>	ILD1	t <sub>PLH</sub>		1.4		μs
		ILQ1	t <sub>PLH</sub>		1.4		μs
		ILD2	t <sub>PLH</sub>		2.3		μs
		ILQ2	t <sub>PLH</sub>		2.3		μs
		ILD5	t <sub>PLH</sub>		2.5		μs
		ILQ5	t <sub>PLH</sub>		2.5		μs



SWITCHING CHARACTERISTICS ( $T_{amb} = 25\text{ }^{\circ}\text{C}$ , unless otherwise specified)							
PARAMETER	TEST CONDITION	PART	SYMBOL	MIN.	TYP.	MAX.	UNIT
<b>SATURATED</b>							
Current	$V_{CE} = 0.4\text{ V}$ , $R_L = 1\text{ k}\Omega$ , $V_{CC} = 5\text{ V}$ , $V_{TH} = 1.5\text{ V}$	ILD1	$I_F$		20		mA
		ILQ1	$I_F$		20		mA
		ILD2	$I_F$		5		mA
		ILQ2	$I_F$		5		mA
		ILD5	$I_F$		10		mA
		ILQ5	$I_F$		10		mA
Delay	$V_{CE} = 0.4\text{ V}$ , $R_L = 1\text{ k}\Omega$ , $V_{CC} = 5\text{ V}$ , $V_{TH} = 1.5\text{ V}$	ILD1	$t_D$		0.8		$\mu\text{s}$
		ILQ1	$t_D$		0.8		$\mu\text{s}$
		ILD2	$t_D$		1		$\mu\text{s}$
		ILQ2	$t_D$		1		$\mu\text{s}$
		ILD5	$t_D$		1.7		$\mu\text{s}$
		ILQ5	$t_D$		1.7		$\mu\text{s}$
Rise time	$V_{CE} = 0.4\text{ V}$ , $R_L = 1\text{ k}\Omega$ , $V_{CC} = 5\text{ V}$ , $V_{TH} = 1.5\text{ V}$	ILD1	$t_r$		1.2		$\mu\text{s}$
		ILQ1	$t_r$		1.2		$\mu\text{s}$
		ILD2	$t_r$		2		$\mu\text{s}$
		ILQ2	$t_r$		2		$\mu\text{s}$
		ILD5	$t_r$		7		$\mu\text{s}$
		ILQ5	$t_r$		7		$\mu\text{s}$
Storage	$V_{CE} = 0.4\text{ V}$ , $R_L = 1\text{ k}\Omega$ , $V_{CC} = 5\text{ V}$ , $V_{TH} = 1.5\text{ V}$	ILD1	$t_s$		7.4		$\mu\text{s}$
		ILQ1	$t_s$		7.4		$\mu\text{s}$
		ILD2	$t_s$		5.4		$\mu\text{s}$
		ILQ2	$t_s$		5.4		$\mu\text{s}$
		ILD5	$t_s$		4.6		$\mu\text{s}$
		ILQ5	$t_s$		4.6		$\mu\text{s}$
Fall time	$V_{CE} = 0.4\text{ V}$ , $R_L = 1\text{ k}\Omega$ , $V_{CC} = 5\text{ V}$ , $V_{TH} = 1.5\text{ V}$	ILD1	$t_f$		7.6		$\mu\text{s}$
		ILQ1	$t_f$		7.6		$\mu\text{s}$
		ILD2	$t_f$		13.5		$\mu\text{s}$
		ILQ2	$t_f$		13.5		$\mu\text{s}$
		ILD5	$t_f$		20		$\mu\text{s}$
		ILQ5	$t_f$		20		$\mu\text{s}$
Propagation H to L	$V_{CE} = 0.4\text{ V}$ , $R_L = 1\text{ k}\Omega$ , $V_{CC} = 5\text{ V}$ , $V_{TH} = 1.5\text{ V}$	ILD1	$t_{PHL}$		1.6		$\mu\text{s}$
		ILQ1	$t_{PHL}$		1.6		$\mu\text{s}$
		ILD2	$t_{PHL}$		5.4		$\mu\text{s}$
		ILQ2	$t_{PHL}$		5.4		$\mu\text{s}$
		ILD5	$t_{PHL}$		2.6		$\mu\text{s}$
		ILQ5	$t_{PHL}$		2.6		$\mu\text{s}$
Propagation L to H	$V_{CE} = 0.4\text{ V}$ , $R_L = 1\text{ k}\Omega$ , $V_{CC} = 5\text{ V}$ , $V_{TH} = 1.5\text{ V}$	ILD1	$t_{PLH}$		8.6		$\mu\text{s}$
		ILQ1	$t_{PLH}$		8.6		$\mu\text{s}$
		ILD2	$t_{PLH}$		7.4		$\mu\text{s}$
		ILQ2	$t_{PLH}$		7.4		$\mu\text{s}$
		ILD5	$t_{PLH}$		7.2		$\mu\text{s}$
		ILQ5	$t_{PLH}$		7.2		$\mu\text{s}$

<b>COMMON MODE TRANSIENT IMMUNITY</b> ( $T_{amb} = 25\text{ }^{\circ}\text{C}$ , unless otherwise specified)						
PARAMETER	TEST CONDITION	SYMBOL	MIN.	TYP.	MAX.	UNIT
Common mode rejection, output high	$V_{CM} = 50\text{ V}_{P-P}$ , $R_L = 1\text{ k}\Omega$ , $I_F = 0\text{ mA}$	$CM_H$		5000		V/ $\mu\text{s}$
Common mode rejection, output low	$V_{CM} = 50\text{ V}_{P-P}$ , $R_L = 1\text{ k}\Omega$ , $I_F = 10\text{ mA}$	$CM_L$		5000		V/ $\mu\text{s}$
Common mode coupling capacitance		$C_{CM}$		0.01		pF

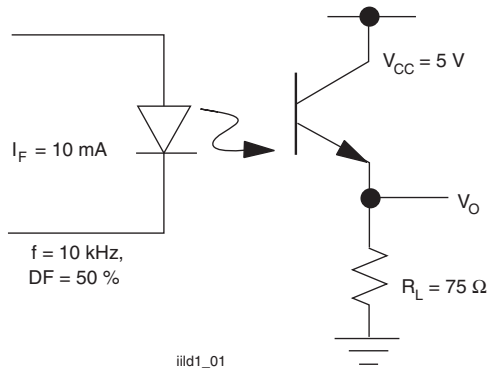
**TYPICAL CHARACTERISTICS** ( $T_{amb} = 25\text{ }^{\circ}\text{C}$ , unless otherwise specified)


Fig. 3 - Non-Saturated Switching Schematic

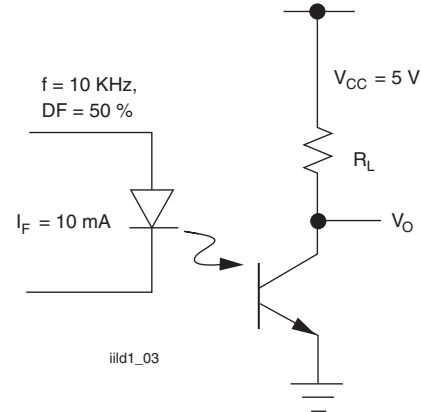


Fig. 5 - Saturated Switching Schematic

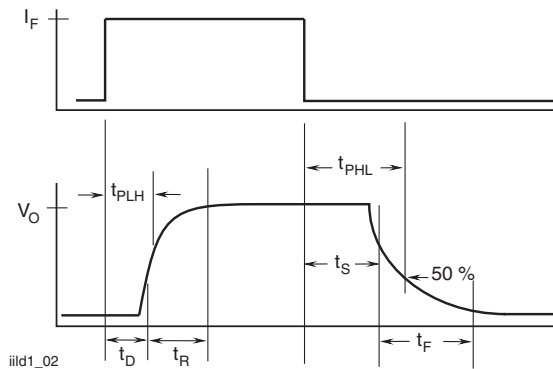


Fig. 4 - Non-Saturated Switching Timing

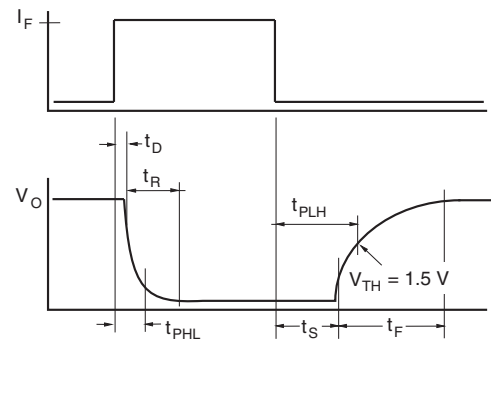


Fig. 6 - Saturated Switching Timing

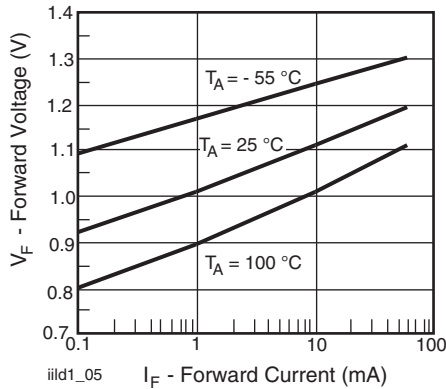


Fig. 7 - Normalized Non-Saturated and Saturated CTR vs. LED Current

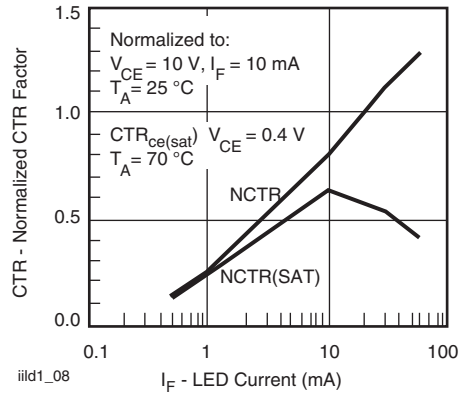


Fig. 10 - Normalized Non-Saturated and Saturated CTR vs. LED Current

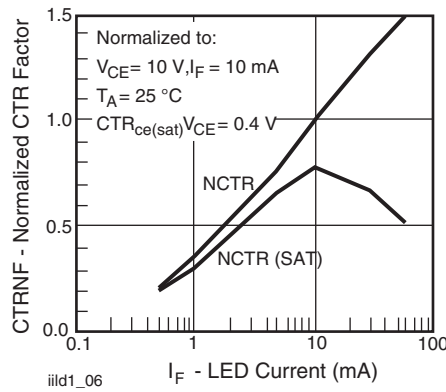


Fig. 8 - Normalized Non-Saturated and Saturated CTR vs. LED Current

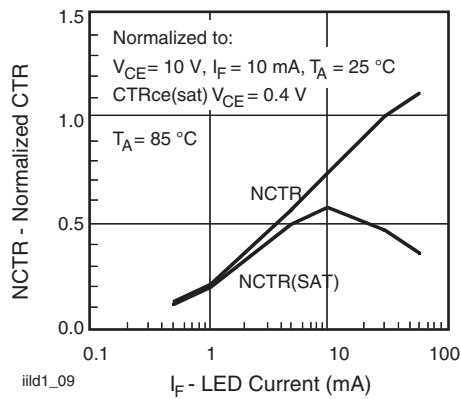


Fig. 11 - Normalized Non-Saturated and Saturated CTR vs. LED Current

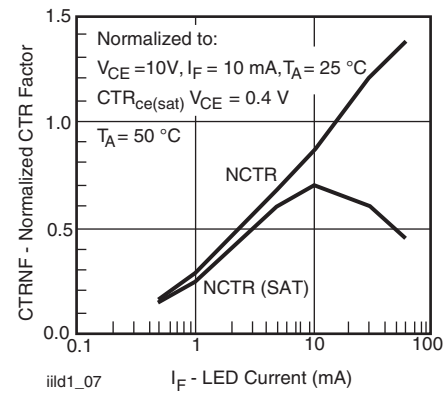


Fig. 9 - Normalized Non-Saturated and Saturated CTR vs. LED Current

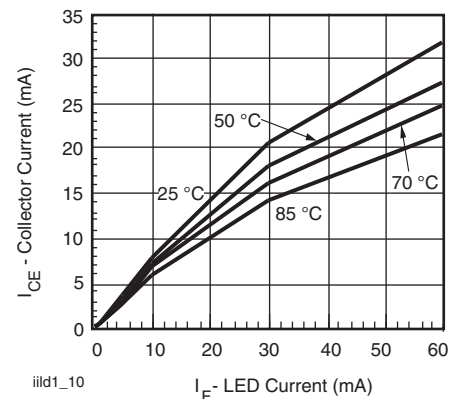


Fig. 12 - Collector Emitter Current vs. Temperature and LED Current



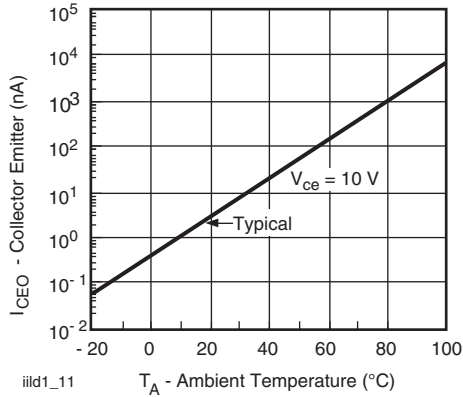


Fig. 13 - Collector Emitter Leakage Current vs. Temperature

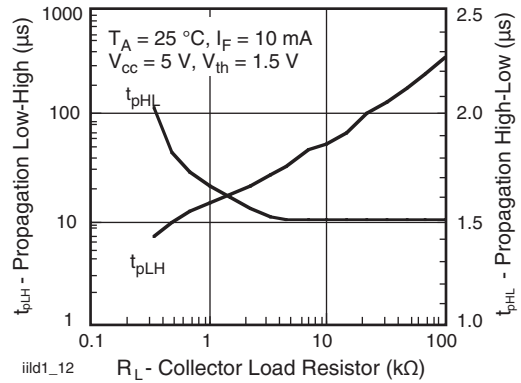
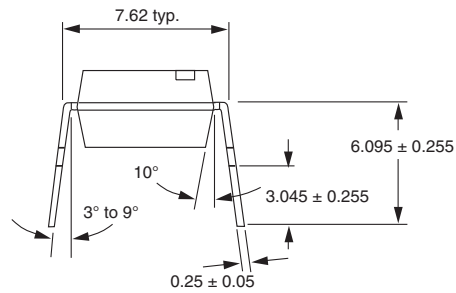
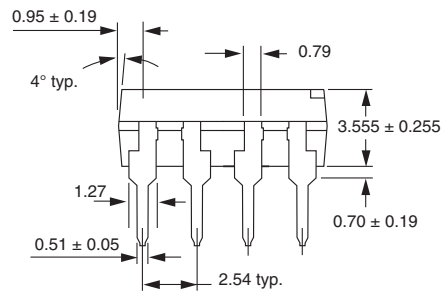
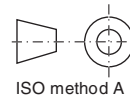
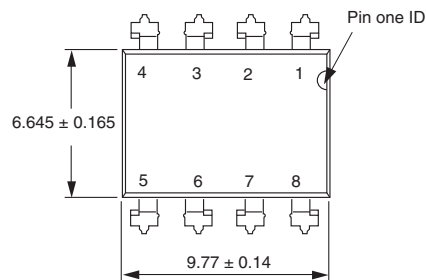


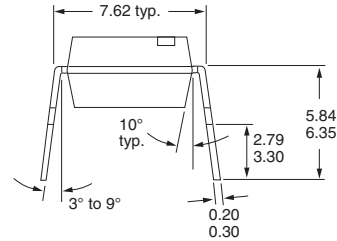
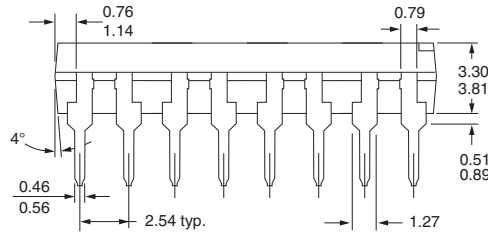
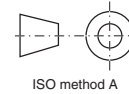
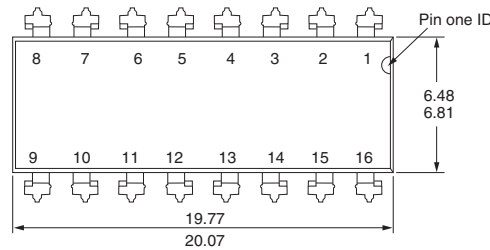
Fig. 14 - Propagation Delay vs. Collector Load Resistor

## PACKAGE DIMENSIONS in millimeters



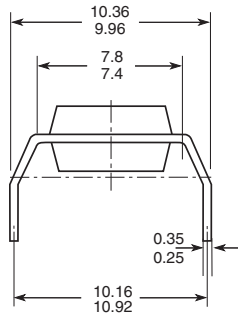
i178006

## PACKAGE DIMENSIONS in millimeters

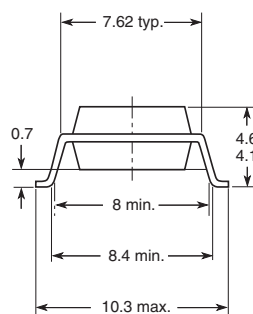


i178007

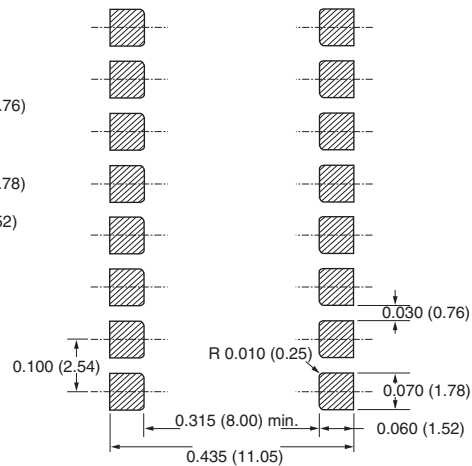
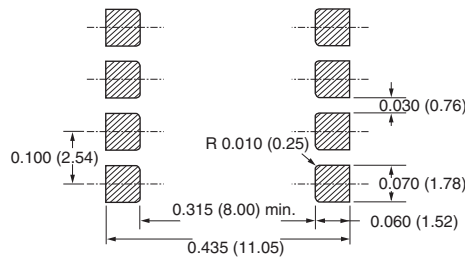
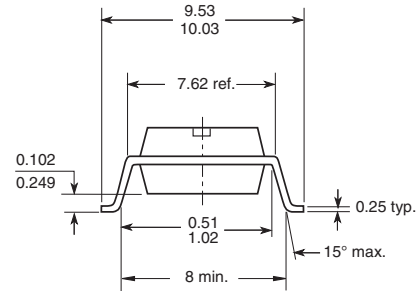
Option 6



Option 7

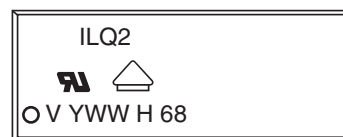
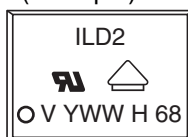


Option 9



18450-9

## PACKAGE MARKING (example)



### Notes

- Only option 1 and 7 reflected in the package marking.
- The VDE logo is only marked on option 1 parts.
- Tape and reel suffix (T) is not part of the package marking.



## **Disclaimer**

ALL PRODUCT, PRODUCT SPECIFICATIONS AND DATA ARE SUBJECT TO CHANGE WITHOUT NOTICE TO IMPROVE RELIABILITY, FUNCTION OR DESIGN OR OTHERWISE.

Vishay Intertechnology, Inc., its affiliates, agents, and employees, and all persons acting on its or their behalf (collectively, "Vishay"), disclaim any and all liability for any errors, inaccuracies or incompleteness contained in any datasheet or in any other disclosure relating to any product.

Vishay makes no warranty, representation or guarantee regarding the suitability of the products for any particular purpose or the continuing production of any product. To the maximum extent permitted by applicable law, Vishay disclaims (i) any and all liability arising out of the application or use of any product, (ii) any and all liability, including without limitation special, consequential or incidental damages, and (iii) any and all implied warranties, including warranties of fitness for particular purpose, non-infringement and merchantability.

Statements regarding the suitability of products for certain types of applications are based on Vishay's knowledge of typical requirements that are often placed on Vishay products in generic applications. Such statements are not binding statements about the suitability of products for a particular application. It is the customer's responsibility to validate that a particular product with the properties described in the product specification is suitable for use in a particular application. Parameters provided in datasheets and / or specifications may vary in different applications and performance may vary over time. All operating parameters, including typical parameters, must be validated for each customer application by the customer's technical experts. Product specifications do not expand or otherwise modify Vishay's terms and conditions of purchase, including but not limited to the warranty expressed therein.

Except as expressly indicated in writing, Vishay products are not designed for use in medical, life-saving, or life-sustaining applications or for any other application in which the failure of the Vishay product could result in personal injury or death. Customers using or selling Vishay products not expressly indicated for use in such applications do so at their own risk. Please contact authorized Vishay personnel to obtain written terms and conditions regarding products designed for such applications.

No license, express or implied, by estoppel or otherwise, to any intellectual property rights is granted by this document or by any conduct of Vishay. Product names and markings noted herein may be trademarks of their respective owners.