

1 Form A Solid State Relay

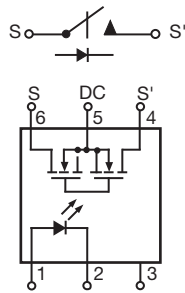

FEATURES

- Isolation test voltage 5300 V_{RMS}
- Current limit protection
- High reliability monolithic detector
- Low power consumption
- Clean bounce free switching
- High surge capability
- Surface mountable
- Compliant to RoHS Directive 2002/95/EC and in accordance to WEEE 2002/96/EC

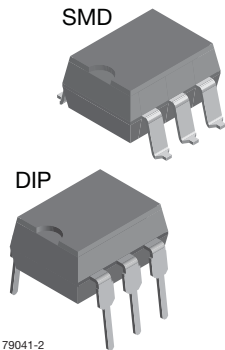

RoHS
COMPLIANT

DESCRIPTION

Vishay solid state relays (SSRs) are miniature, optically coupled relays with high-voltage MOSFET outputs. The LH1518 relays are capable of switching AC or DC loads from as little as nanovolts to hundreds of volts.

The relays can switch currents in the range of nanoamps to hundreds of milliamps. The MOSFET switches are ideal for small signal switching and are primarily suited for DC or audio frequency applications.

The LH1518 relays feature a monolithic output die that minimizes wire bonds and permits easy integration of high-performance circuits such as current limiting in normally-open switches. The output die integrates the photodiode receptor array, turn-on and turn-off control circuitry, and the MOSFET switches. The optically-coupled input is controlled by a highly efficient GaAlAs infrared LED.

APPLICATIONS

- General telecom switching
- Instrumentation
- Industrial controls

AGENCY APPROVALS

UL1577: file no. E52744 system code H, double protection
 CSA: certification no. 093751
 BSI: certification no. 7979/7980
 DIN EN: 60747-5-2 (VDE 0884)/60747-5-5 (pending), available with option 1
 FIMKO: 25419

ORDERING INFORMATION

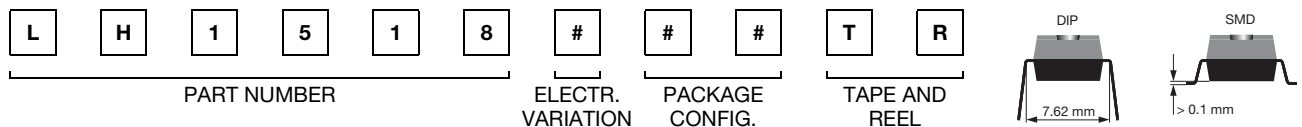

PACKAGE	UL, CSA, BSI, FIMKO
SMD-6, tubes	LH1518AAB
SMD-6, tape and reel	LH1518AABTR
DIP-6, tubes	LH1518AT

ABSOLUTE MAXIMUM RATINGS (T_{amb} = 25 °C, unless otherwise specified)

PARAMETER	TEST CONDITION	SYMBOL	VALUE	UNIT
INPUT				
LED continuous forward current		I _F	50	mA
LED reverse voltage	I _R ≤ 10 μA	V _R	8	V
OUTPUT				
DC or peak AC load voltage		V _L	250	V
Continuous DC load current, bidirektional operation		I _L	155	mA
Continuous DC load current, unidirektional operation		I _L	300	mA
Peak load current (single shot)	t = 100 ms	I _P	(1)	

ABSOLUTE MAXIMUM RATINGS ($T_{amb} = 25\text{ }^{\circ}\text{C}$, unless otherwise specified)				
PARAMETER	TEST CONDITION	SYMBOL	VALUE	UNIT
SSR				
Ambient temperature range		T_{amb}	- 40 to + 85	$^{\circ}\text{C}$
Storage temperature range		T_{stg}	- 40 to + 150	$^{\circ}\text{C}$
Pin soldering temperature ⁽²⁾	t = 10 s max.	T_{sld}	260	$^{\circ}\text{C}$
Input to output isolation voltage		V_{ISO}	5300	V_{RMS}
Output power dissipation (continuous)		P_{diss}	550	mW

Notes

- Stresses in excess of the absolute maximum ratings can cause permanent damage to the device. Functional operation of the device is not implied at these or any other conditions in excess of those given in the operational sections of this document. Exposure to absolute maximum ratings for extended periods of the time can adversely affect reliability.

⁽¹⁾ Refer to current limit performance application note 58 for a discussion on relay operation during transient currents.

⁽²⁾ Refer to reflow profile for soldering conditions for surface mounted devices (SMD). Refer to wave profile for soldering conditions for through hole devices (DIP).

ELECTRICAL CHARACTERISTICS ($T_{amb} = 25\text{ }^{\circ}\text{C}$, unless otherwise specified)						
PARAMETER	TEST CONDITION	SYMBOL	MIN.	TYP.	MAX.	UNIT
INPUT						
LED forward current switch turn-on	$I_L = 100\text{ mA}$, t = 10 ms	I_{Fon}		0.8	2	mA
LED forward current switch turn-off	$V_L = \pm 200\text{ V}$	I_{Foff}	0.2	0.7		mA
LED forward voltage	$I_F = 10\text{ mA}$	V_F	1.15	1.26	1.45	V
OUTPUT						
On-resistance AC/DC: pin 4 (\pm) to 6 (\pm)	$I_F = 5\text{ mA}$, $I_L = 50\text{ mA}$	R_{ON}	10	15	20	Ω
Off-resistance DC: pin 4, 6 (+) to 5 (\pm)	$I_F = 5\text{ mA}$, $I_L = 100\text{ mA}$	R_{ON}	2.5	3.75	5	Ω
Off-resistance	$I_F = 0\text{ mA}$, $V_L = \pm 100\text{ V}$	R_{OFF}	0.5	5000		G Ω
Current limit AC ⁽¹⁾ : pin 4 (\pm) to 6 (\pm)	$I_F = 5\text{ mA}$, t = 5 ms, $V_L = \pm 6\text{ V}$	I_{LMT}	170	200	280	mA
Off-state leakage current	$I_F = 0\text{ mA}$, $V_L = \pm 100\text{ V}$	I_O		0.02	200	nA
	$I_F = 0\text{ mA}$, $V_L = \pm 250\text{ V}$	I_O			1	μA
Output capacitance pin 4 to 6	$I_F = 0\text{ mA}$, $V_L = 1\text{ V}$	C_O		55		pF
	$I_F = 0\text{ mA}$, $V_L = 50\text{ V}$	C_O		10		pF
Switch offset	$I_F = 5\text{ mA}$	V_{OS}		0.15		μV
TRANSFER						
Capacitance (input to output)	$V_{ISO} = 1\text{ V}$	C_{IO}		0.8		pF

Notes

- Minimum and maximum values are testing requirements. Typical values are characteristics of the device and are the result of engineering evaluations. Typical values are for information only and are not part of the testing requirements.

⁽¹⁾ No DC mode current limit available.

SWITCHING CHARACTERISTICS ($T_{amb} = 25\text{ }^{\circ}\text{C}$, unless otherwise specified)						
PARAMETER	TEST CONDITION	SYMBOL	MIN.	TYP.	MAX.	UNIT
Turn-on time	$I_F = 5\text{ mA}$, $I_L = 50\text{ mA}$	t_{on}		1.4	3	ms
Turn-off time	$I_F = 5\text{ mA}$, $I_L = 50\text{ mA}$	t_{off}		0.7	3	ms



SAFETY AND INSULATION RATINGS				
PARAMETER	TEST CONDITION	SYMBOL	VALUE	UNIT
Climatic classification	IEC 68 part 1		40/85/21	
Pollution degree	DIN VDE 0109		2	
Tracking resistance (comparative tracking index)	Insulation group IIIa	CTI	175	
Highest allowable overvoltage	Transient overvoltage	V_{IOTM}	8000	V_{peak}
Max. working insulation voltage	Recurring peak voltage	V_{IORM}	890	V_{peak}
Insulation resistance at 25 °C	$V_{IO} = 500 V$	R_{IS}	$\geq 10^{12}$	Ω
Insulation resistance at T_S		R_{IS}	$\geq 10^9$	Ω
Insulation resistance at 100 °C		R_{IS}	$\geq 10^{11}$	Ω
Partial discharge test voltage	Methode a, $V_{pd} = V_{IORM} \times 1.875$	V_{pd}	1669	V_{peak}
Safety limiting values - maximum values allowed in the event of a failure	Case temperature	T_{SI}	175	°C
	Input current	I_{SI}	300	mA
	Output power	P_{SO}	700	mW
Minimum external air gap (clearance)	Measured from input terminals to output terminals, shortest distance through air		≥ 7	mm
Minimum external tracking (creepage)	Measured from input terminals to output terminals, shortest distance path along body		≥ 7	mm

TYPICAL CHARACTERISTICS ($T_{amb} = 25\text{ °C}$, unless otherwise specified)

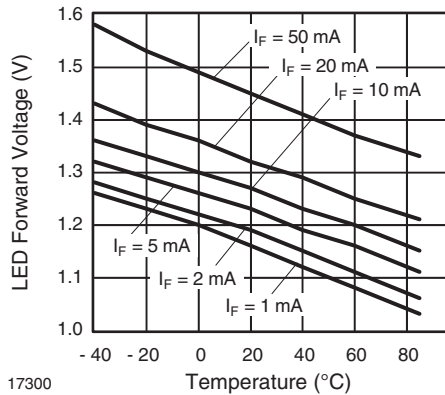

Fig. 1 - LED Voltage vs. Temperature

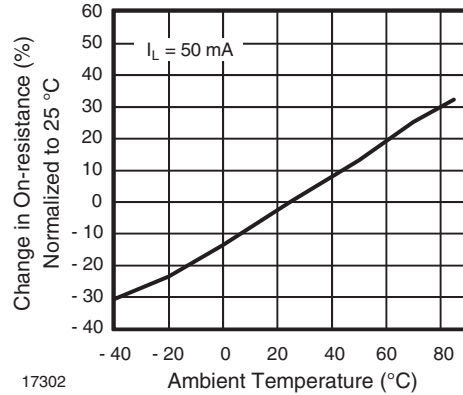

Fig. 3 - On-resistance vs. Temperature

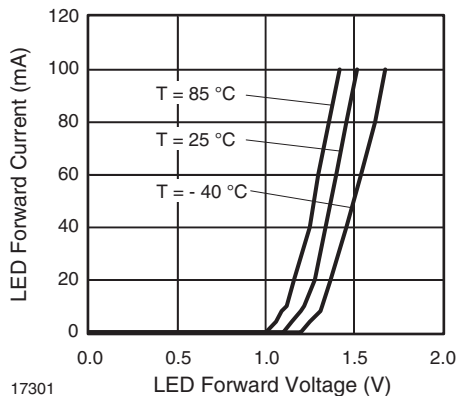

Fig. 2 - LED Forward Current vs. LED Forward Voltage

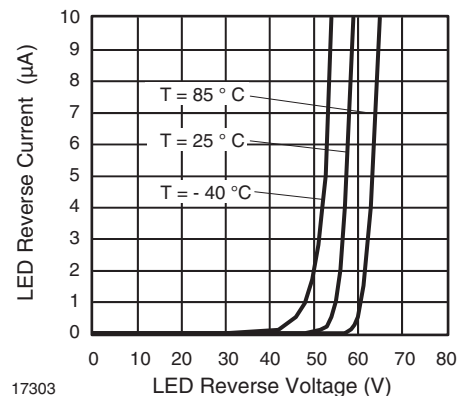

Fig. 4 - LED Reverse Current vs. LED Reverse Voltage

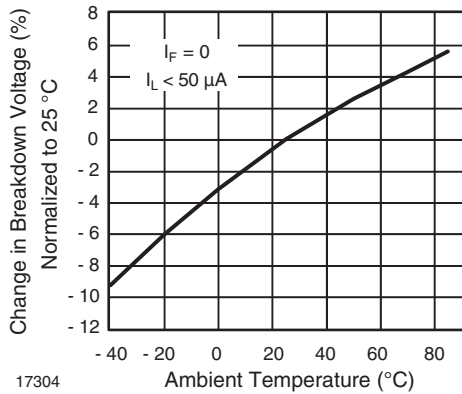

Fig. 5 - Switch Breakdown Voltage vs. Temperature

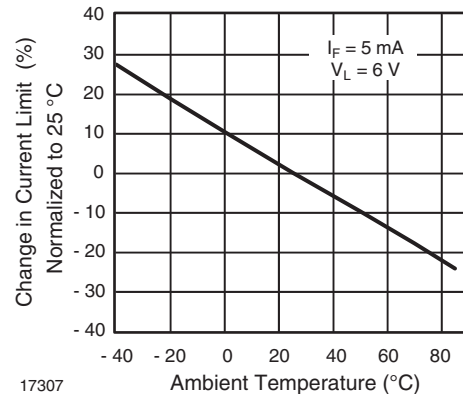

Fig. 8 - Current Limit vs. Temperature

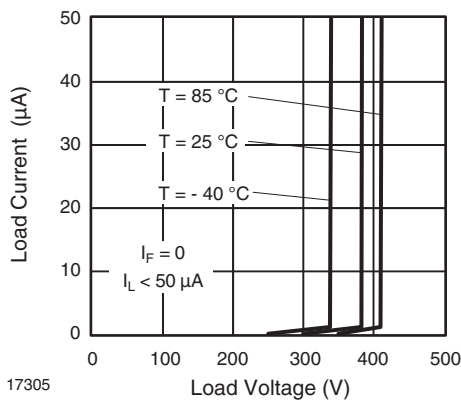

Fig. 6 - Switch Breakdown Voltage vs. Load Current

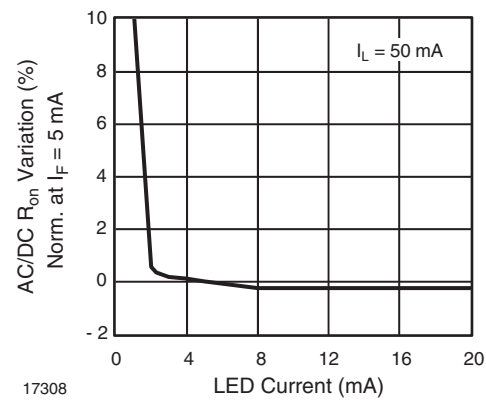

Fig. 9 - Variation in On-resistance vs. LED Current

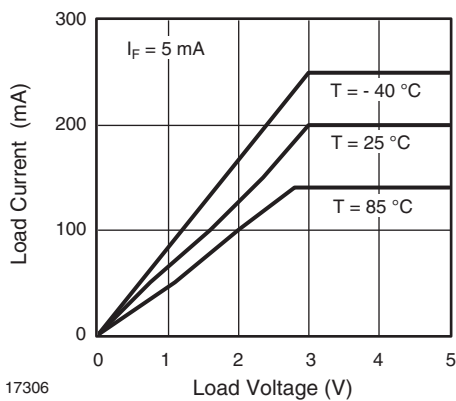

Fig. 7 - Load Current vs. Load Voltage

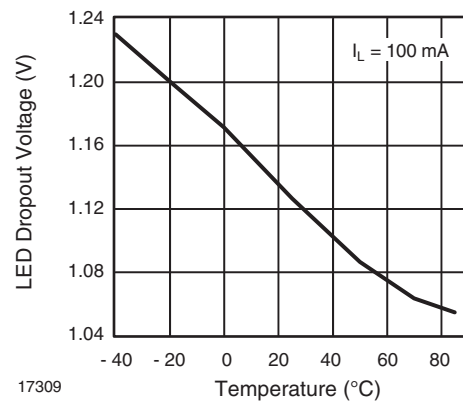

Fig. 10 - LED Dropout Voltage vs. Temperature



LH1518AAB, LH1518AABTR, LH1518AT

1 Form A Solid State Relay

Vishay Semiconductors

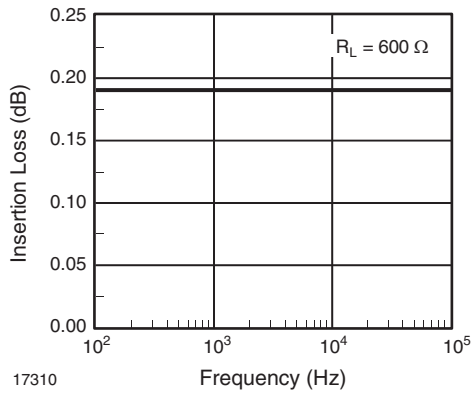

Fig. 11 - Insertion Loss vs. Frequency

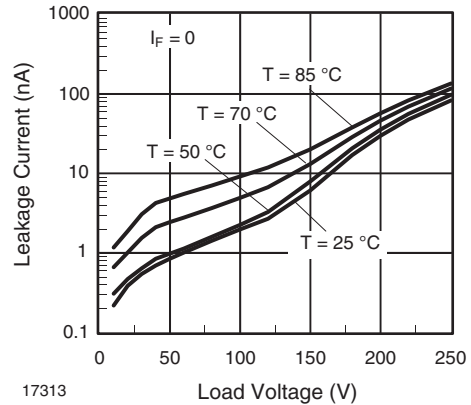

Fig. 14 - Leakage Current vs. Applied Voltage

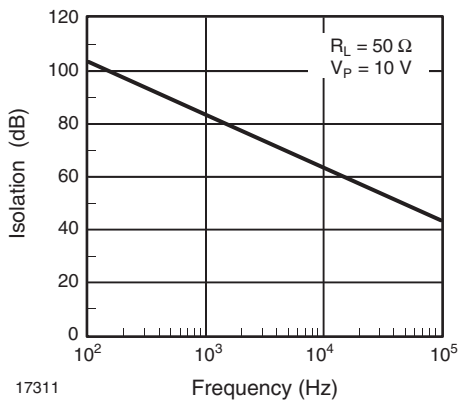

Fig. 12 - Output Isolation

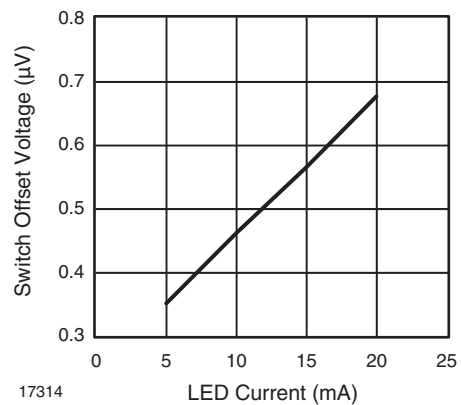

Fig. 15 - Switch Offset Voltage vs. LED Current

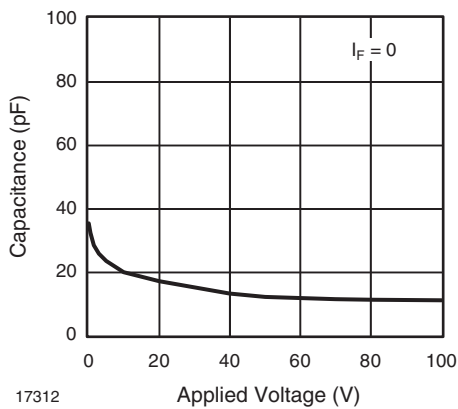

Fig. 13 - Switch Capacitance vs. Applied Voltage

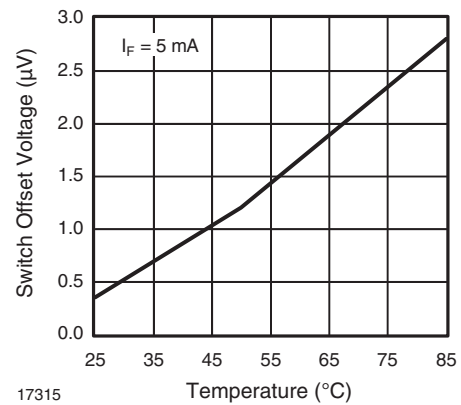

Fig. 16 - Switch Offset Voltage vs. Temperature

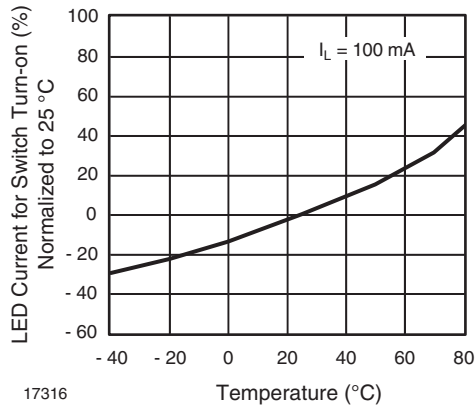

Fig. 17 - LED Current for Switch Turn-on vs. Temperature

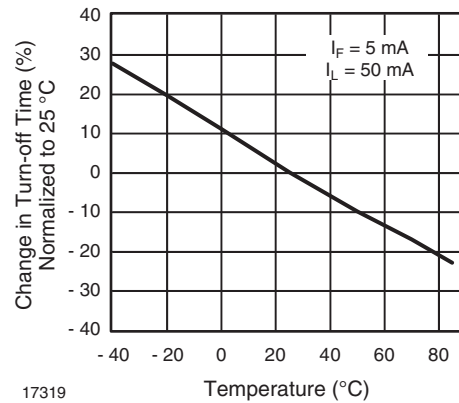

Fig. 20 - Turn-off Time vs. Temperature

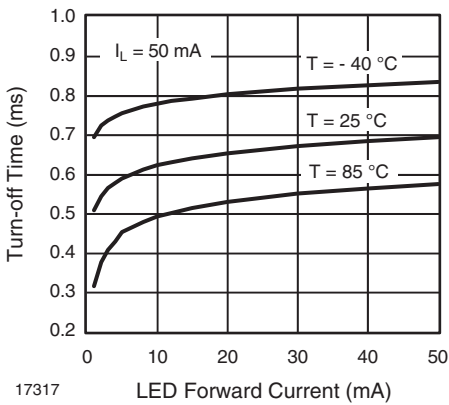

Fig. 18 - Turn-off Time vs. LED Current

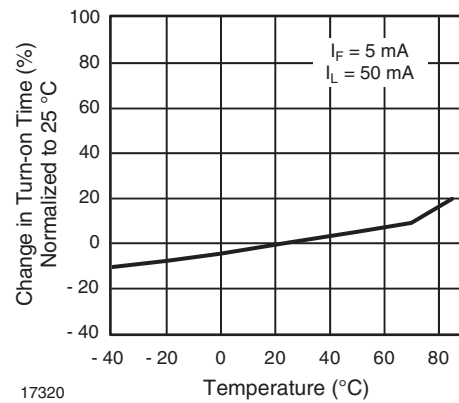

Fig. 21 - Turn-on Time vs. Temperature

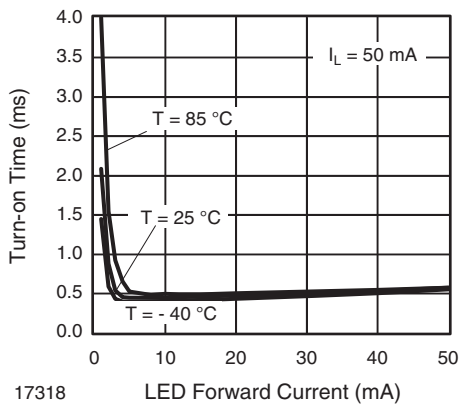

Fig. 19 - Turn-on Time vs. LED Current



LH1518AAB, LH1518AABTR, LH1518AT

1 Form A Solid State Relay

Vishay Semiconductors

PACKAGE DIMENSIONS in millimeters

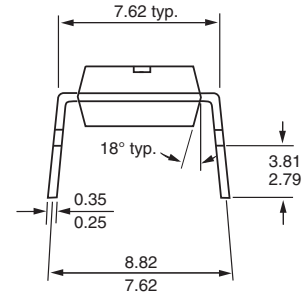
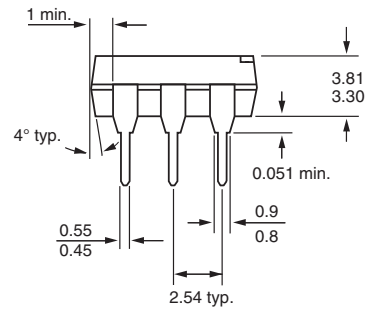
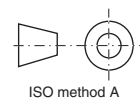
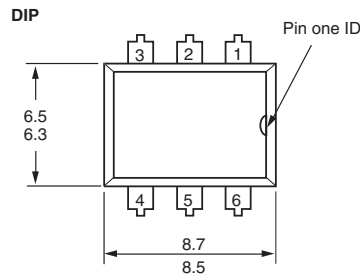

i178001

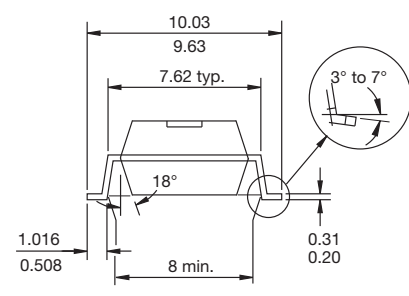
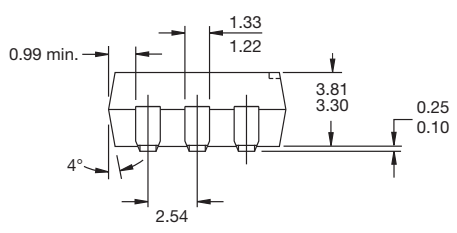
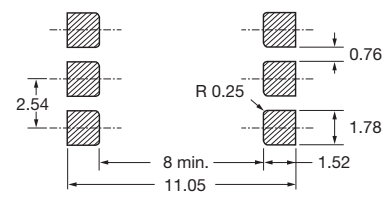
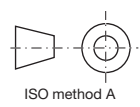
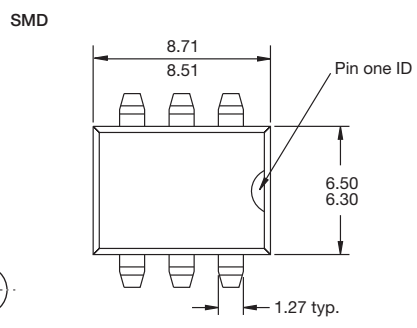

i178002

PACKAGE MARKING

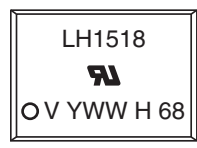

Note

- Tape and reel suffix (TR) is not part of the package marking.



Disclaimer

ALL PRODUCT, PRODUCT SPECIFICATIONS AND DATA ARE SUBJECT TO CHANGE WITHOUT NOTICE TO IMPROVE RELIABILITY, FUNCTION OR DESIGN OR OTHERWISE.

Vishay Intertechnology, Inc., its affiliates, agents, and employees, and all persons acting on its or their behalf (collectively, "Vishay"), disclaim any and all liability for any errors, inaccuracies or incompleteness contained in any datasheet or in any other disclosure relating to any product.

Vishay makes no warranty, representation or guarantee regarding the suitability of the products for any particular purpose or the continuing production of any product. To the maximum extent permitted by applicable law, Vishay disclaims (i) any and all liability arising out of the application or use of any product, (ii) any and all liability, including without limitation special, consequential or incidental damages, and (iii) any and all implied warranties, including warranties of fitness for particular purpose, non-infringement and merchantability.

Statements regarding the suitability of products for certain types of applications are based on Vishay's knowledge of typical requirements that are often placed on Vishay products in generic applications. Such statements are not binding statements about the suitability of products for a particular application. It is the customer's responsibility to validate that a particular product with the properties described in the product specification is suitable for use in a particular application. Parameters provided in datasheets and / or specifications may vary in different applications and performance may vary over time. All operating parameters, including typical parameters, must be validated for each customer application by the customer's technical experts. Product specifications do not expand or otherwise modify Vishay's terms and conditions of purchase, including but not limited to the warranty expressed therein.

Except as expressly indicated in writing, Vishay products are not designed for use in medical, life-saving, or life-sustaining applications or for any other application in which the failure of the Vishay product could result in personal injury or death. Customers using or selling Vishay products not expressly indicated for use in such applications do so at their own risk. Please contact authorized Vishay personnel to obtain written terms and conditions regarding products designed for such applications.

No license, express or implied, by estoppel or otherwise, to any intellectual property rights is granted by this document or by any conduct of Vishay. Product names and markings noted herein may be trademarks of their respective owners.