

LM8261 Single RRIO High Output Current & Unlimited Cap Load Op Amp

1 Features

- ($V_S = 5\text{ V}$, $T_A = 25^\circ\text{C}$, Typical Values Unless Specified)
- GBWP 21 MHz
- Wide Supply Voltage Range 2.5 V to 30 V
- Slew Rate 12 V/ μs
- Supply Current 0.97 mA
- Cap Load Limit Unlimited
- Output Short Circuit Current 53 mA/ -75 mA
- $\pm 5\%$ Settling Time 400 ns (500 pF, 100 mV_{PP} Step)
- Input Common Mode Voltage 0.3 V Beyond Rails
- Input Voltage Noise $15\text{ nV}/\sqrt{\text{Hz}}$
- Input Current Noise $1\text{ pA}/\sqrt{\text{Hz}}$
- THD+N < 0.05%

2 Applications

- TFT-LCD Flat Panel V_{COM} Driver
- A/D Converter Buffer
- High Side/low Side Sensing
- Headphone Amplifier

3 Description

The LM8261 is a Rail-to-Rail input and output Op Amp which can operate with a wide supply voltage range. This device has high output current drive, greater than Rail-to-Rail input common mode voltage range, unlimited capacitive load drive capability, and provides tested and guaranteed high speed and slew rate while requiring only 0.97 mA supply current. It is specifically designed to handle the requirements of flat panel TFT panel V_{COM} driver applications as well as being suitable for other low power, and medium speed applications which require ease of use and enhanced performance over existing devices.

Greater than Rail-to-Rail input common mode voltage range with 50 dB of Common Mode Rejection allows high side and low side sensing, among many applications, without concern over exceeding the range and with no compromise in accuracy. Exceptionally wide operating supply voltage range of 2.5 V to 30 V alleviates any concerns over functionality under extreme conditions and offers flexibility for use in multitude of applications. In addition, most device parameters are insensitive to power supply variations; this design enhancement is yet another step in simplifying its usage. The output stage has low distortion (0.05% THD+N) and can supply a respectable amount of current (15 mA) with minimal headroom from either rail (300 mV).

The LM8261 is offered in the space-saving SOT-23-5 package.

Device Information⁽¹⁾

| PART NUMBER | PACKAGE | BODY SIZE (NOM) |
|-------------|------------|-----------------|
| LM8261 | SOT-23 (5) | 2.9 mm x 1.6 mm |

(1) For all available packages, see the orderable addendum at the end of the data sheet.

Output Response with Heavy Capacitive Load

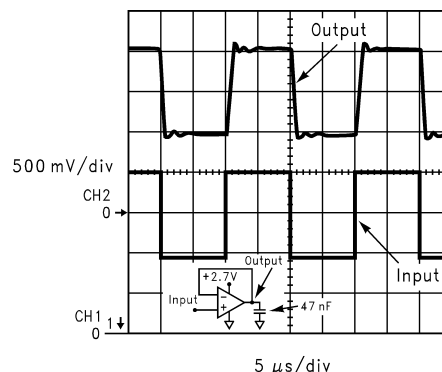

Table of Contents

| | | | |
|---|-----------|--|-----------|
| 1 Features | 1 | 7.2 Driving Capacitive Loads | 20 |
| 2 Applications | 1 | 7.3 Estimating the Output Voltage Swing | 22 |
| 3 Description | 1 | 7.4 TFT Applications | 23 |
| 4 Revision History | 2 | 7.5 Output Short Circuit Current and Dissipation Issues | 23 |
| 5 Pin Configuration and Functions | 3 | 7.6 Other Application Hints | 24 |
| 6 Specifications | 4 | 8 Power Supply Recommendations | 25 |
| 6.1 Absolute Maximum Ratings | 4 | 9 Layout | 25 |
| 6.2 ESD Ratings | 4 | 9.1 Layout Guidelines | 25 |
| 6.3 Recommended Operating Conditions | 4 | 9.2 Layout Example | 26 |
| 6.4 Thermal Information | 4 | 10 Device and Documentation Support | 27 |
| 6.5 Electrical Characteristics 2.7 V | 5 | 10.1 Documentation Support | 27 |
| 6.6 Electrical Characteristics 5 V | 7 | 10.2 Trademarks | 27 |
| 6.7 Electrical Characteristics ±15 V | 9 | 10.3 Electrostatic Discharge Caution | 27 |
| 6.8 Typical Characteristics | 11 | 10.4 Glossary | 27 |
| 7 Application and Implementation | 19 | 11 Mechanical, Packaging, and Orderable Information | 27 |
| 7.1 Block Diagram and Operational Description | 19 | | |

4 Revision History

Changes from Revision I (March 2013) to Revision J

Page

- Added, updated, or revised the following sections: *Pin Configuration and Functions*, *Specifications*, *Detailed Description*, *Application and Implementation*, *Power Supply Recommendations*, *Layout*, *Device and Documentation Support*, and *Mechanical, Packaging, and Orderable Information* section **1**
- Changed from -1.0 V to -0.8 V in *Specifications* **4**

Changes from Revision H (March 2013) to Revision I

Page

- Changed layout of National Data Sheet to TI format **1**

5 Pin Configuration and Functions

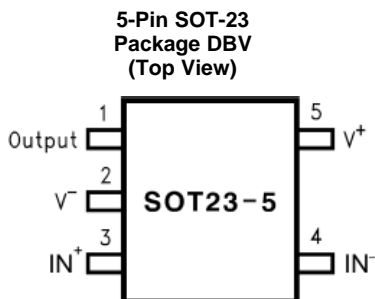

Pin Functions

| PIN | | I/O | DESCRIPTION |
|--------|--------|-----|---------------------|
| NUMBER | NAME | | |
| 1 | Output | O | Output |
| 2 | V- | I | Negative Supply |
| 3 | IN+ | I | Non-inverting input |
| 4 | IN- | I | Inverting Input |
| 5 | V+ | I | Positive Supply |

6 Specifications

6.1 Absolute Maximum Ratings⁽¹⁾

| | MIN | MAX | UNIT |
|---|----------------------------------|---|------|
| V _{IN} Differential | | ±10 | V |
| Output Short Circuit Duration | See ⁽²⁾⁽³⁾ | | |
| Supply Voltage (V ⁺ - V ⁻) | | 32 | V |
| Voltage at Input/Output pins | | V ⁺ +0.8 V, V ⁻ -0.8 V | V |
| Storage Temperature Range | -65 | +150 | °C |
| Junction Temperature ⁽⁴⁾ | | 150 | °C |
| Soldering Information: | Infrared or Convection (20 sec.) | 235 | °C |
| | Wave Soldering (10 sec.) | 260 | °C |

- (1) Absolute Maximum Ratings indicate limits beyond which damage to the device may occur. Operating Rating indicate conditions for which the device is intended to be functional, but specific performance is not guaranteed. For guaranteed specifications and the test conditions, see [Electrical Characteristics 2.7 V](#).
- (2) Applies to both single-supply and split-supply operation. Continuous short circuit operation at elevated ambient temperature can result in exceeding the maximum allowed junction temperature of 150°C.
- (3) Allowable Output Short Circuit duration is infinite for V_S ≤ 6 V at room temperature and below. For V_S > 6 V, allowable short circuit duration is 1.5 ms.
- (4) The maximum power dissipation is a function of T_{J(max)}, R_{θJA}, and T_A. The maximum allowable power dissipation at any ambient temperature is P_D = (T_{J(MAX)} - T_A) / R_{θJA}. All numbers apply for packages soldered directly onto a PC board.

6.2 ESD Ratings

| | VALUE | UNIT |
|--|--|-------|
| V _(ESD) Electrostatic discharge | Human-body model (HBM), per ANSI/ESDA/JEDEC JS-001 ⁽¹⁾⁽²⁾ | ±2000 |
| | Machine model (MM) ⁽³⁾ | ±200 |

- (1) JEDEC document JEP155 states that 500-V HBM allows safe manufacturing with a standard ESD control process. Manufacturing with less than 2000-V HBM is possible with the necessary precautions. Pins listed as ±200 V may actually have higher performance.
- (2) Human Body Model is 1.5 kΩ in series with 100 pF.
- (3) Machine Model, 0 Ω is series with 200 pF.

6.3 Recommended Operating Conditions

| | MIN | MAX | UNIT |
|---|-----|-----|------|
| Supply Voltage (V ⁺ - V ⁻) | 2.5 | 30 | V |
| Temperature Range ⁽¹⁾ | -40 | +85 | °C |

- (1) The maximum power dissipation is a function of T_{J(max)}, R_{θJA}, and T_A. The maximum allowable power dissipation at any ambient temperature is P_D = (T_{J(MAX)} - T_A) / R_{θJA}. All numbers apply for packages soldered directly onto a PC board.

6.4 Thermal Information

| THERMAL METRIC ⁽¹⁾⁽²⁾ | DBV | UNIT |
|---|----------|------|
| | (5 PINS) | |
| R _{θJA} Junction-to-ambient thermal resistance | 325 | °C/W |

- (1) For more information about traditional and new thermal metrics, see the *IC Package Thermal Metrics* application report, [SPRA953](#).
- (2) The maximum power dissipation is a function of T_{J(max)}, R_{θJA}, and T_A. The maximum allowable power dissipation at any ambient temperature is P_D = (T_{J(MAX)} - T_A) / R_{θJA}. All numbers apply for packages soldered directly onto a PC board.

6.5 Electrical Characteristics 2.7 V

Unless otherwise specified, all limits guaranteed for $T_A = 25^\circ\text{C}$, $V^+ = 2.7\text{ V}$, $V^- = 0\text{ V}$, $V_{\text{CM}} = 0.5\text{ V}$, $V_O = V^+/2$, and $R_L > 1\text{ M}\Omega$ to V^- .⁽¹⁾

| PARAMETER | | TEST CONDITIONS | | MIN | TYP ⁽²⁾ | MAX ⁽³⁾ | UNIT |
|--|---------------------------------------|--|--|-----|--------------------|--------------------|------------------------|
| V_{OS} | Input Offset Voltage | $V_{\text{CM}} = 0.5\text{ V}$ & $V_{\text{CM}} = 2.2\text{ V}$ | | | +/-0.7 | +/-5 | mV |
| | | | $-65^\circ\text{C} \leq T_J \leq +150^\circ\text{C}$ | | | +/-7 | |
| TC V_{OS} | Input Offset Average Drift | $V_{\text{CM}} = 0.5\text{ V}$ & $V_{\text{CM}} = 2.2\text{ V}$ ⁽⁴⁾ | | | +/-2 | | $\mu\text{V}/\text{C}$ |
| I_B | Input Bias Current | $V_{\text{CM}} = 0.5\text{ V}$ ⁽⁵⁾ | | | -1.20 | -2.00 | μA |
| | | | $-65^\circ\text{C} \leq T_J \leq +150^\circ\text{C}$ | | | -2.70 | |
| I_B | Input Bias Current | $V_{\text{CM}} = 2.2\text{ V}$ ⁽⁵⁾ | | | +0.49 | +1.00 | μA |
| | | | $-65^\circ\text{C} \leq T_J \leq +150^\circ\text{C}$ | | | +1.60 | |
| I_{OS} | Input Offset Current | $V_{\text{CM}} = 0.5\text{ V}$ & $V_{\text{CM}} = 2.2\text{ V}$ | | | 20 | 250 | nA |
| | | | $-65^\circ\text{C} \leq T_J \leq +150^\circ\text{C}$ | | | 400 | |
| CMRR | Common Mode Rejection Ratio | V_{CM} stepped from 0 V to 1.0 V | | | 100 | 76 | dB |
| | | | $-65^\circ\text{C} \leq T_J \leq +150^\circ\text{C}$ | | 60 | | |
| | | | V_{CM} stepped from 1.7 V to 2.7 V | | | 100 | |
| | | V_{CM} stepped from 0 V to 2.7 V | | | 70 | 58 | |
| | | | $-65^\circ\text{C} \leq T_J \leq +150^\circ\text{C}$ | | 50 | | |
| +PSRR | Positive Power Supply Rejection Ratio | $V^+ = 2.7\text{ V}$ to 5 V | | | 104 | 78 | dB |
| | | | $-65^\circ\text{C} \leq T_J \leq +150^\circ\text{C}$ | | 74 | | |
| CMVR | Input Common-Mode Voltage Range | CMRR > 50 dB | | | -0.3 | -0.1 | V |
| | | | $-65^\circ\text{C} \leq T_J \leq +150^\circ\text{C}$ | | | 0.0 | |
| | | | $-65^\circ\text{C} \leq T_J \leq +150^\circ\text{C}$ | | | 2.7 | 2.8 |
| A_{VOL} | Large Signal Voltage Gain | $V_O = 0.5$ to 2.2 V , $R_L = 10\text{K}$ to V^- | | | 78 | 70 | dB |
| | | | $-65^\circ\text{C} \leq T_J \leq +150^\circ\text{C}$ | | 67 | | |
| | | $V_O = 0.5$ to 2.2 V , $R_L = 2\text{K}$ to V^- | | | 73 | 67 | dB |
| | | | $-65^\circ\text{C} \leq T_J \leq +150^\circ\text{C}$ | | 63 | | |
| V_O | Output Swing High | $R_L = 10\text{K}$ to V^- | | | 2.59 | 2.49 | V |
| | | | $-65^\circ\text{C} \leq T_J \leq +150^\circ\text{C}$ | | 2.46 | | |
| | | | $R_L = 2\text{K}$ to V^- | | | 2.53 | 2.45 |
| $-65^\circ\text{C} \leq T_J \leq +150^\circ\text{C}$ | | | | | 2.41 | | |
| I_{SC} | Output Short Circuit Current | Sourcing to V^- $V_{\text{ID}} = 200\text{ mV}$ ⁽⁶⁾⁽⁷⁾ | | | 48 | 30 | mA |
| | | | $-65^\circ\text{C} \leq T_J \leq +150^\circ\text{C}$ | | 20 | | |
| | | Sinking to V^+ $V_{\text{ID}} = -200\text{ mV}$ ⁽⁶⁾⁽⁷⁾ | | | 65 | 50 | mA |
| | | | $-65^\circ\text{C} \leq T_J \leq +150^\circ\text{C}$ | | 30 | | |

- (1) Electrical Table values apply only for factory testing conditions at the temperature indicated. Factory testing conditions result in very limited self-heating of the device such that $T_J = T_A$. No guarantee of parametric performance is indicated in the electrical tables under conditions of internal self heating where $T_J > T_A$.
- (2) Typical Values represent the most likely parametric norm.
- (3) All limits are guaranteed by testing or statistical analysis.
- (4) Offset voltage average drift determined by dividing the change in V_{OS} at temperature extremes into the total temperature change.
- (5) Positive current corresponds to current flowing into the device.
- (6) Production Short Circuit test is a momentary test. See [Note 7](#).
- (7) Allowable Output Short Circuit duration is infinite for $V_S \leq 6\text{ V}$ at room temperature and below. For $V_S > 6\text{ V}$, allowable short circuit duration is 1.5 ms.

Electrical Characteristics 2.7 V (continued)

Unless otherwise specified, all limits guaranteed for $T_A = 25^\circ\text{C}$, $V^+ = 2.7\text{ V}$, $V^- = 0\text{ V}$, $V_{CM} = 0.5\text{ V}$, $V_O = V^+/2$, and $R_L > 1\text{ M}\Omega$ to V^- .⁽¹⁾

| PARAMETER | | TEST CONDITIONS | MIN | TYP ⁽²⁾ | MAX ⁽³⁾ | UNIT |
|-----------|------------------------------|---|-----|--------------------|--------------------|------------------------|
| I_S | Supply Current | No load, $V_{CM} = 0.5\text{ V}$ $-65^\circ\text{C} \leq T_J \leq +150^\circ\text{C}$ | | 0.95 | 1.20 | mA |
| | | | | | 1.50 | |
| SR | Slew Rate ⁽⁸⁾ | $A_V = +1, V_I = 2\text{ V}_{PP}$ | | 9 | | V/ μs |
| f_u | Unity Gain-Frequency | $V_I = 10\text{ mV}, R_L = 2\text{ K}\Omega$ to $V^+/2$ | | 10 | | MHz |
| GBWP | Gain Bandwidth Product | $f = 50\text{ KHz}$ $-65^\circ\text{C} \leq T_J \leq +150^\circ\text{C}$ | | 21 | 15.5 | MHz |
| | | | | 14 | | |
| Φ_m | Phase Margin | $V_I = 10\text{ mV}$ | | 50 | | Deg |
| e_n | Input-Referred Voltage Noise | $f = 2\text{ KHz}, R_S = 50\ \Omega$ | | 15 | | nV/ $\sqrt{\text{Hz}}$ |
| i_n | Input-Referred Current Noise | $f = 2\text{ KHz}$ | | 1 | | pA/ $\sqrt{\text{Hz}}$ |
| f_{MAX} | Full Power Bandwidth | $Z_L = (20\text{ pF} \parallel 10\text{ K}\Omega)$ to $V^+/2$ | | 1 | | MHz |

(8) Slew rate is the slower of the rising and falling slew rates. Connected as a Voltage Follower.

6.6 Electrical Characteristics 5 V⁽¹⁾

Unless otherwise specified, all limited guaranteed for $T_A = 25^\circ\text{C}$, $V^+ = 5\text{ V}$, $V^- = 0\text{ V}$, $V_{\text{CM}} = 1\text{ V}$, $V_O = V^+/2$, and $R_L > 1\text{ M}\Omega$ to V^- .

| PARAMETER | | TEST CONDITIONS | MIN | TYP ⁽²⁾ | MAX ⁽³⁾ | UNIT | |
|--------------------|---------------------------------------|--|---------------------------------|--------------------|--------------------|-------|----|
| V _{OS} | Input Offset Voltage | V _{CM} = 1 V & V _{CM} = 4.5 V | -65°C ≤ T _J ≤ +150°C | +/-0.7 | +/-5 | mV | |
| | | | | | +/- 7 | | |
| TC V _{OS} | Input Offset Average Drift | V _{CM} = 1 V & V _{CM} = 4.5 V ⁽⁴⁾ | | +/-2 | | μV/°C | |
| I _B | Input Bias Current | V _{CM} = 1 V ⁽⁵⁾ | -65°C ≤ T _J ≤ +150°C | -1.18 | -2.00 | μA | |
| | | | | | -2.70 | | |
| I _{OS} | Input Offset Current | V _{CM} = 1 V & V _{CM} = 4.5 V | -65°C ≤ T _J ≤ +150°C | 20 | 250 | nA | |
| | | | | | 400 | | |
| CMRR | Common Mode Rejection Ratio | V _{CM} stepped from 0 V to 3.3 V | -65°C ≤ T _J ≤ +150°C | 72 | 110 | 84 | dB |
| | | | | | 100 | | |
| | | | | | 80 | 64 | |
| +PSRR | Positive Power Supply Rejection Ratio | V ⁺ = 2.7 V to 5 V, V _{CM} = 0.5 V | -65°C ≤ T _J ≤ +150°C | 74 | 104 | 78 | dB |
| | | | | | | | |
| CMVR | Input Common-Mode Voltage Range | CMRR > 50 dB | -65°C ≤ T _J ≤ +150°C | | -0.3 | -0.1 | V |
| | | | | | | 0.0 | |
| | | | | | 5.3 | 5.1 | V |
| A _{VOL} | Large Signal Voltage Gain | V _O = 0.5 to 4.5 V, R _L = 10 K to V ⁻ | -65°C ≤ T _J ≤ +150°C | 70 | 84 | 74 | dB |
| | | | | | 80 | 70 | |
| V _O | Output Swing High | R _L = 10 K to V ⁻ | -65°C ≤ T _J ≤ +150°C | | 4.87 | 4.75 | V |
| | | | | | 4.72 | | |
| | Output Swing Low | R _L = 2 K to V ⁻ | -65°C ≤ T _J ≤ +150°C | | 4.81 | 4.70 | mV |
| | | | | 4.66 | | | |
| I _{SC} | Output Short Circuit Current | Sourcing to V ⁻ V _{ID} = 200 mV ⁽⁶⁾⁽⁷⁾ | -65°C ≤ T _J ≤ +150°C | 20 | 53 | 35 | mA |
| | | | | | 75 | 60 | |
| | | Sinking to V ⁺ V _{ID} = -200 mV ⁽⁶⁾⁽⁷⁾ | -65°C ≤ T _J ≤ +150°C | 50 | | | |

- (1) Electrical Table values apply only for factory testing conditions at the temperature indicated. Factory testing conditions result in very limited self-heating of the device such that T_J = T_A. No guarantee of parametric performance is indicated in the electrical tables under conditions of internal self heating where T_J > T_A.
- (2) Typical Values represent the most likely parametric norm.
- (3) All limits are guaranteed by testing or statistical analysis.
- (4) Offset voltage average drift determined by dividing the change in V_{OS} at temperature extremes into the total temperature change.
- (5) Positive current corresponds to current flowing into the device.
- (6) Production Short Circuit test is a momentary test. See [Note 7](#).
- (7) Allowable Output Short Circuit duration is infinite for V_S ≤ 6V at room temperature and below. For V_S > 6V, allowable short circuit duration is 1.5ms.

Electrical Characteristics 5 V⁽¹⁾ (continued)

Unless otherwise specified, all limited guaranteed for $T_A = 25^\circ\text{C}$, $V^+ = 5\text{ V}$, $V^- = 0\text{ V}$, $V_{CM} = 1\text{ V}$, $V_O = V^+/2$, and $R_L > 1\text{ M}\Omega$ to V^- .

| PARAMETER | | TEST CONDITIONS | MIN | TYP ⁽²⁾ | MAX ⁽³⁾ | UNIT |
|-----------|-----------------------------------|--|--|--------------------|--------------------|------------------------|
| I_S | Supply Current | No load, $V_{CM} = 1\text{ V}$ | | 0.97 | 1.25 | mA |
| | | | $-65^\circ\text{C} \leq T_J \leq +150^\circ\text{C}$ | | 1.75 | |
| SR | Slew Rate ⁽⁸⁾ | $A_V = +1$, $V_I = 5\text{ V}_{PP}$ | | 12 | 10 | V/ μs |
| | | | $-65^\circ\text{C} \leq T_J \leq +150^\circ\text{C}$ | 7 | | |
| f_u | Unity Gain Frequency | $V_I = 10\text{ mV}$, $R_L = 2\text{ K}\Omega$ to $V^+/2$ | | 10.5 | | MHz |
| GBWP | Gain-Bandwidth Product | $f = 50\text{ KHz}$ | | 21 | 16 | MHz |
| | | | $-65^\circ\text{C} \leq T_J \leq +150^\circ\text{C}$ | 15 | | |
| Φ_m | Phase Margin | $V_I = 10\text{ mV}$ | | 53 | | Deg |
| e_n | Input-Referred Voltage Noise | $f = 2\text{ KHz}$, $R_S = 50\ \Omega$ | | 15 | | nV/ $\sqrt{\text{Hz}}$ |
| i_n | Input-Referred Current Noise | $f = 2\text{ KHz}$ | | 1 | | pA/ $\sqrt{\text{Hz}}$ |
| f_{MAX} | Full Power Bandwidth | $Z_L = (20\text{ pF} \parallel 10\text{ k}\Omega)$ to $V^+/2$ | | 900 | | KHz |
| t_S | Settling Time ($\pm 5\%$) | 100 mV _{PP} Step, 500 pF load | | 400 | | ns |
| THD+N | Total Harmonic Distortion + Noise | $R_L = 1\text{ K}\Omega$ to $V^+/2$ $f = 10\text{ KHz}$ to $A_V = +2$, 4 V _{PP} swing | | 0.05% | | |

(8) Slew rate is the slower of the rising and falling slew rates. Connected as a Voltage Follower.

6.7 Electrical Characteristics ±15 V⁽¹⁾

Unless otherwise specified, all limited guaranteed for $T_A = 25^\circ\text{C}$, $V^+ = 15\text{ V}$, $V^- = -15\text{ V}$, $V_{CM} = 0\text{ V}$, $V_O = 0\text{ V}$, and $R_L > 1\text{ M}\Omega$ to 0 V .

| PARAMETER | | TEST CONDITIONS | | MIN | TYP ⁽²⁾ | MAX ⁽³⁾ | UNIT |
|------------------|---------------------------------------|--|--|--------|--------------------|--------------------|------------------------------|
| V_{OS} | Input Offset Voltage | $V_{CM} = -14.5\text{ V}$ & $V_{CM} = 14.5\text{ V}$ | | | +/-0.7 | +/-7 | mV |
| | | | $-65^\circ\text{C} \leq T_J \leq +150^\circ\text{C}$ | | | +/- 9 | |
| TC V_{OS} | Input Offset Average Drift | $V_{CM} = -14.5\text{ V}$ & $V_{CM} = 14.5\text{ V}$ ⁽⁴⁾ | | | +/-2 | | $\mu\text{V}/^\circ\text{C}$ |
| I_B | Input Bias Current | $V_{CM} = -14.5\text{ V}$ ⁽⁵⁾ | | | -1.05 | -2.00 | μA |
| | | | $-65^\circ\text{C} \leq T_J \leq +150^\circ\text{C}$ | | | -2.80 | |
| I_{OS} | Input Offset Current | $V_{CM} = -14.5\text{ V}$ & $V_{CM} = 14.5\text{ V}$ | | | 30 | 275 | nA |
| | | | $-65^\circ\text{C} \leq T_J \leq +150^\circ\text{C}$ | | | | |
| CMRR | Common Mode Rejection Ratio | V_{CM} stepped from -15 V to 13 V | | | 100 | 84 | dB |
| | | | $-65^\circ\text{C} \leq T_J \leq +150^\circ\text{C}$ | 80 | | | |
| | | | V_{CM} stepped from 14 V to 15 V | | | 100 | |
| +PSRR | Positive Power Supply Rejection Ratio | $V^+ = 12\text{ V}$ to 15 V | | | 100 | 70 | dB |
| | | | $-65^\circ\text{C} \leq T_J \leq +150^\circ\text{C}$ | 66 | | | |
| -PSRR | Negative Power Supply Rejection Ratio | $V^- = -12\text{ V}$ to -15 V | | | 100 | 70 | dB |
| | | | $-65^\circ\text{C} \leq T_J \leq +150^\circ\text{C}$ | 66 | | | |
| CMVR | Input Common-Mode Voltage Range | CMRR > 50 dB | | | -15.3 | -15.1 | V |
| | | | $-65^\circ\text{C} \leq T_J \leq +150^\circ\text{C}$ | | | | |
| | | | $-65^\circ\text{C} \leq T_J \leq +150^\circ\text{C}$ | 15.0 | | | 15.3 |
| A_{VOL} | Large Signal Voltage Gain | $V_O = 0\text{ V}$ to $\pm 13\text{ V}$, $R_L = 10\text{ K}\Omega$ | | | 85 | 78 | dB |
| | | | $-65^\circ\text{C} \leq T_J \leq +150^\circ\text{C}$ | 74 | | | |
| | | $V_O = 0\text{ V}$ to $\pm 13\text{ V}$, $R_L = 2\text{ K}\Omega$ | | | 79 | 72 | |
| | | | $-65^\circ\text{C} \leq T_J \leq +150^\circ\text{C}$ | 66 | | | |
| V_O | Output Swing High | $R_L = 10\text{ K}\Omega$ | | | 14.83 | 14.65 | V |
| | | | $-65^\circ\text{C} \leq T_J \leq +150^\circ\text{C}$ | 14.61 | | | |
| | $R_L = 2\text{ K}\Omega$ | | | | 14.73 | 14.60 | |
| | | $-65^\circ\text{C} \leq T_J \leq +150^\circ\text{C}$ | 14.55 | | | | |
| Output Swing Low | $R_L = 10\text{ K}\Omega$ | | | -14.91 | -14.75 | V | |
| | | $-65^\circ\text{C} \leq T_J \leq +150^\circ\text{C}$ | | | | | -14.65 |
| | | $R_L = 2\text{ K}\Omega$ | | | -14.83 | -14.65 | |
| | | | $-65^\circ\text{C} \leq T_J \leq +150^\circ\text{C}$ | | | | |
| I_{SC} | Output Short Circuit Current | Sourcing to ground $V_{ID} = 200\text{ mV}$ ⁽⁶⁾⁽⁷⁾ | | | 60 | 40 | mA |
| | | | $-65^\circ\text{C} \leq T_J \leq +150^\circ\text{C}$ | 25 | | | |
| | | Sinking to ground $V_{ID} = 200\text{ mV}$ ⁽⁶⁾⁽⁷⁾ | | | 100 | 70 | |
| | | | $-65^\circ\text{C} \leq T_J \leq +150^\circ\text{C}$ | 60 | | | |

- (1) Electrical Table values apply only for factory testing conditions at the temperature indicated. Factory testing conditions result in very limited self-heating of the device such that $T_J = T_A$. No guarantee of parametric performance is indicated in the electrical tables under conditions of internal self heating where $T_J > T_A$.
- (2) Typical Values represent the most likely parametric norm.
- (3) All limits are guaranteed by testing or statistical analysis.
- (4) Offset voltage average drift determined by dividing the change in V_{OS} at temperature extremes into the total temperature change.
- (5) Positive current corresponds to current flowing into the device.
- (6) Production Short Circuit test is a momentary test. See [Note 7](#).
- (7) Allowable Output Short Circuit duration is infinite for $V_S \leq 6\text{ V}$ at room temperature and below. For $V_S > 6\text{ V}$, allowable short circuit duration is 1.5 ms.

Electrical Characteristics $\pm 15\text{ V}^{(1)}$ (continued)

Unless otherwise specified, all limited guaranteed for $T_A = 25^\circ\text{C}$, $V^+ = 15\text{ V}$, $V^- = -15\text{ V}$, $V_{CM} = 0\text{ V}$, $V_O = 0\text{ V}$, and $R_L > 1\text{ M}\Omega$ to 0 V .

| PARAMETER | | TEST CONDITIONS | MIN | TYP ⁽²⁾ | MAX ⁽³⁾ | UNIT |
|-----------|--|---|--|--------------------|--------------------|------------------------|
| I_S | Supply Current | No load, $V_{CM} = 0\text{ V}$ | | 1.30 | 1.50 | mA |
| | | | $-65^\circ\text{C} \leq T_J \leq +150^\circ\text{C}$ | | 1.90 | |
| SR | Slew Rate ⁽⁸⁾ | $A_V = +1$, $V_I = 24\text{ V}_{PP}$ | | 15 | 10 | V/ μs |
| | | | $-65^\circ\text{C} \leq T_J \leq +150^\circ\text{C}$ | 8 | | |
| f_u | Unity Gain Frequency | $V_I = 10\text{ mV}$, $R_L = 2\text{ K}\Omega$ | | 14 | | MHz |
| GBWP | Gain-Bandwidth Product | $f = 50\text{ KHz}$ | | 24 | 18 | MHz |
| | | | $-65^\circ\text{C} \leq T_J \leq +150^\circ\text{C}$ | 16 | | |
| Φ_m | Phase Margin | $V_I = 10\text{ mV}$ | | 58 | | Deg |
| e_n | Input-Referred Voltage Noise | $f = 2\text{ KHz}$, $R_S = 50\ \Omega$ | | 15 | | nV/ $\sqrt{\text{Hz}}$ |
| i_n | Input-Referred Current Noise | $f = 2\text{ KHz}$ | | 1 | | pA/ $\sqrt{\text{Hz}}$ |
| f_{MAX} | Full Power Bandwidth | $Z_L = 20\text{ pF} \parallel 10\text{ K}\Omega$ | | 160 | | KHz |
| t_s | Settling Time ($\pm 1\%$, $A_V = +1$) | Positive Step, 5 V_{PP} | | 320 | | ns |
| | | Negative Step, 5 V_{PP} | | 600 | | |
| THD+N | Total Harmonic Distortion +Noise | $R_L = 1\text{ K}\Omega$, $f = 10\text{ KHz}$, $A_V = +2$, 28 V_{PP} swing | | 0.01% | | |

(8) Slew rate is the slower of the rising and falling slew rates. Connected as a Voltage Follower.

6.8 Typical Characteristics

T_A = 25°C, Unless Otherwise Noted

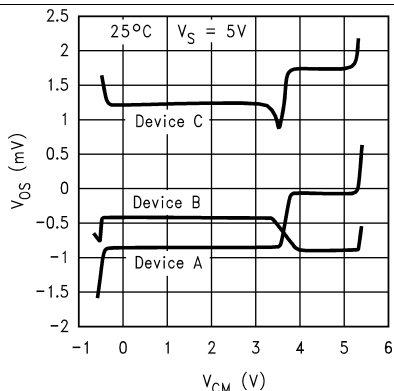

Figure 1. V_{OS} vs. V_{CM} for 3 Representative Units

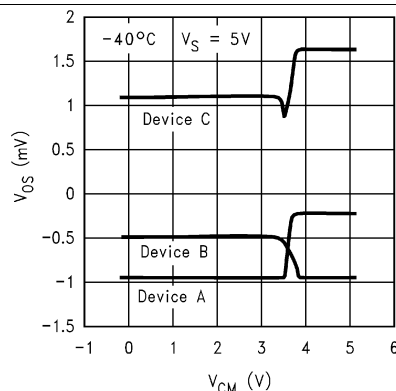

Figure 2. V_{OS} vs. V_{CM} for 3 Representative Units

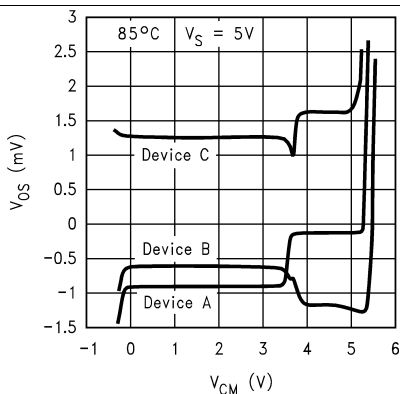

Figure 3. V_{OS} vs. V_{CM} for 3 Representative Units

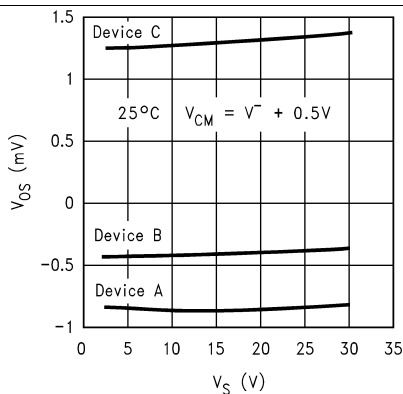

Figure 4. V_{OS} vs. V_S for 3 Representative Units

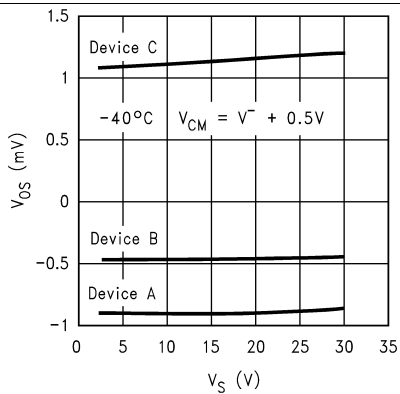

Figure 5. V_{OS} vs. V_S for 3 Representative Units

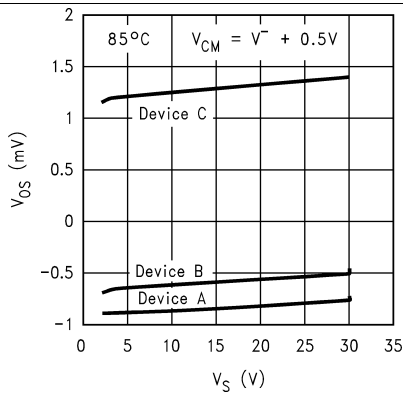

Figure 6. V_{OS} vs. V_S for 3 Representative Units

Typical Characteristics (continued)

T_A = 25°C, Unless Otherwise Noted

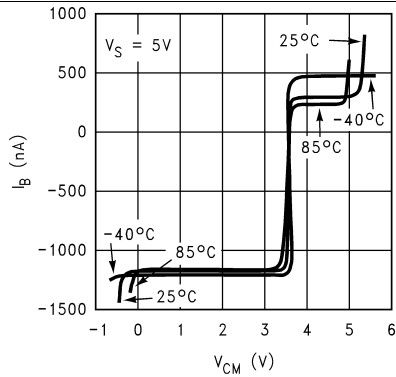

Figure 7. I_B vs. V_{CM}

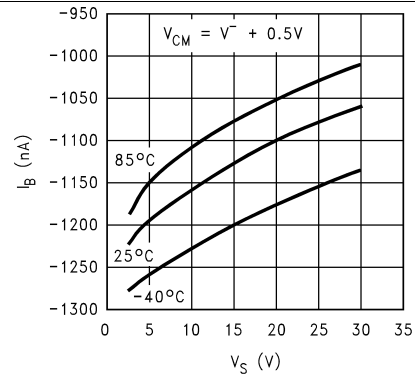

Figure 8. I_B vs. V_S

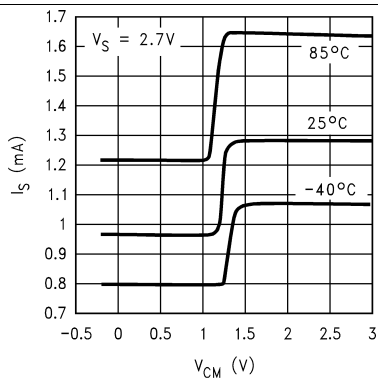

Figure 9. I_S vs. V_{CM}

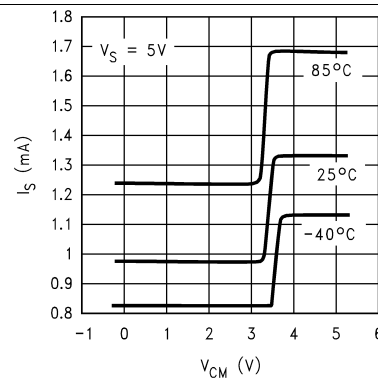

Figure 10. I_S vs. V_{CM}

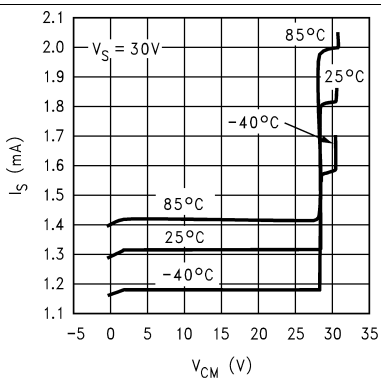

Figure 11. I_S vs. V_{CM}

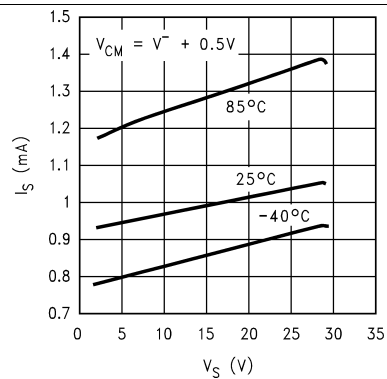

Figure 12. I_S vs. V_S (PNP side)

Typical Characteristics (continued)

T_A = 25°C, Unless Otherwise Noted

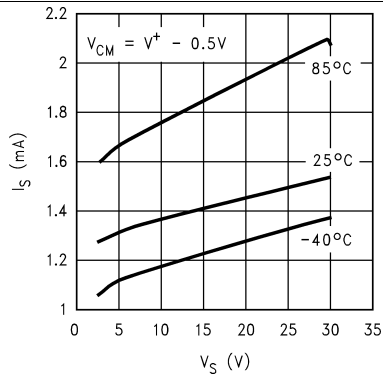

Figure 13. I_S vs. V_S (NPN side)

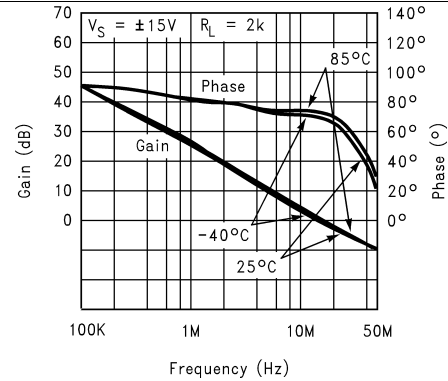

Figure 14. Gain/Phase vs. Frequency

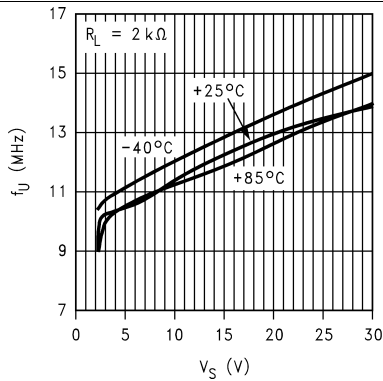

Figure 15. Unity Gain Frequency vs. V_S

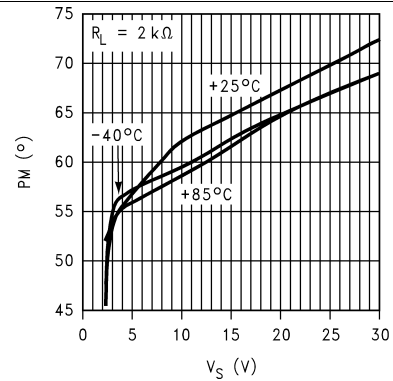

Figure 16. Phase Margin vs. V_S

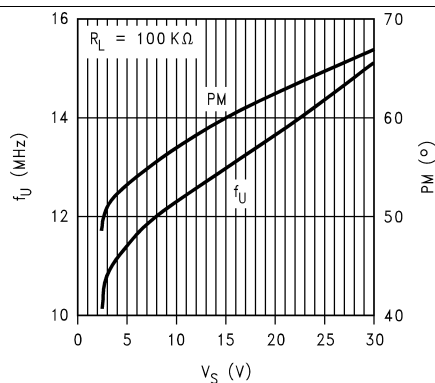

Figure 17. Unity Gain Freq. and Phase Margin vs. V_S

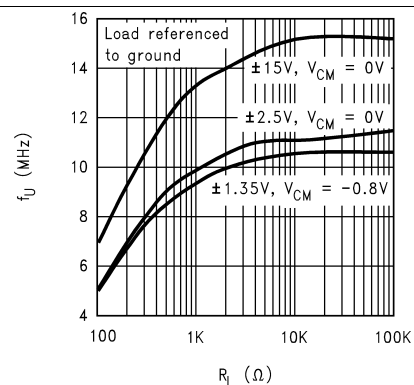

Figure 18. Unity Gain Frequency vs. Load

Typical Characteristics (continued)

T_A = 25°C, Unless Otherwise Noted

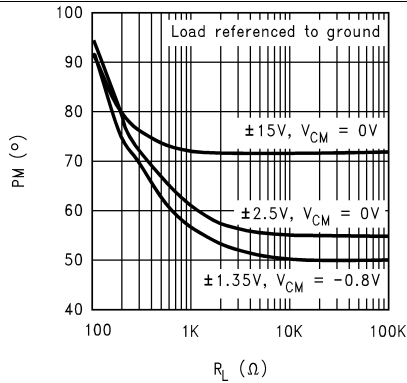

Figure 19. Phase Margin vs. Load

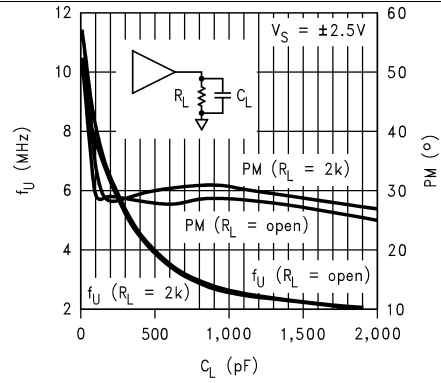

Figure 20. Unity Gain Freq. and Phase Margin vs. CL

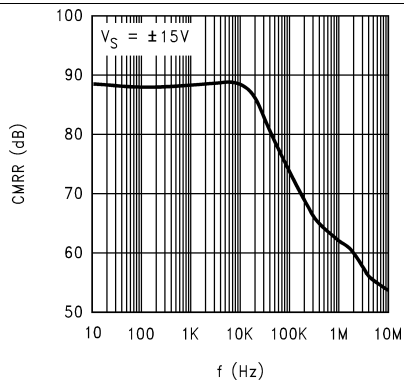

Figure 21. CMRR vs. Frequency

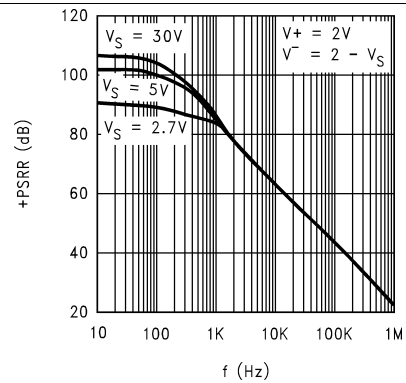

Figure 22. +PSRR vs. Frequency

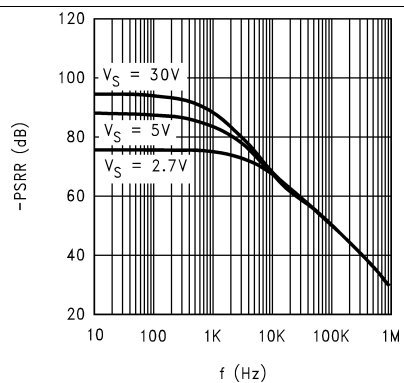

Figure 23. -PSRR vs. Frequency

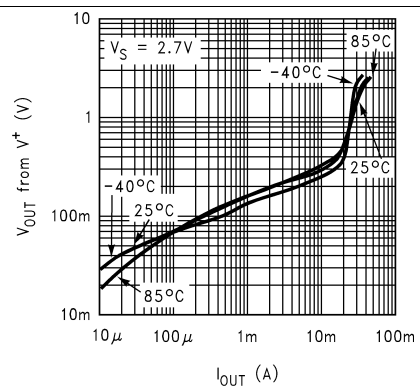

Figure 24. Output Voltage vs. Output Sourcing Current

Typical Characteristics (continued)

T_A = 25°C, Unless Otherwise Noted

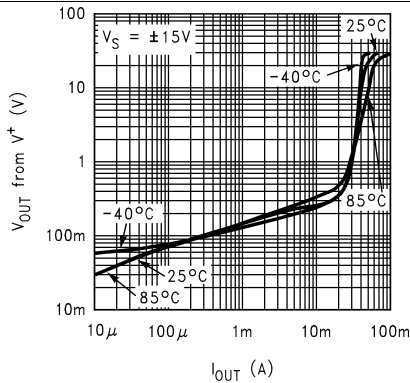

Figure 25. Output Voltage vs. Output Sourcing Current

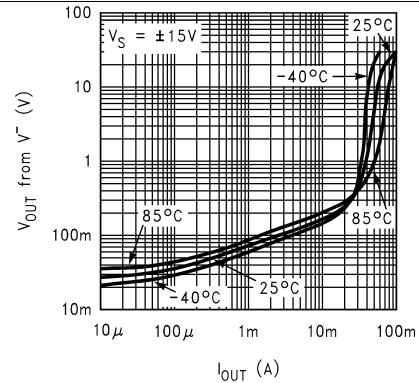

Figure 26. Output Voltage vs. Output Sinking Current

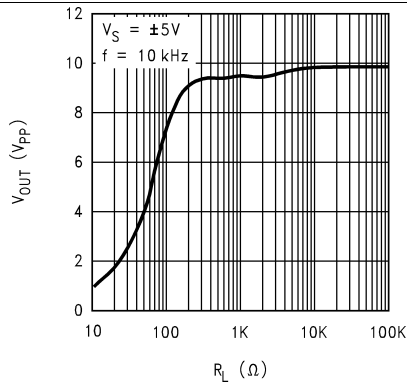

Figure 27. Max Output Swing vs. Load

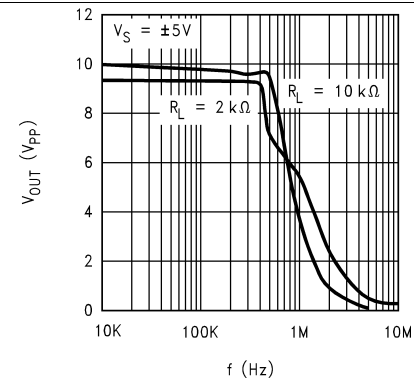

Figure 28. Max Output Swing vs. Frequency

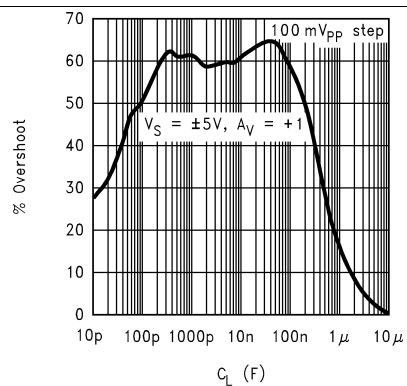

Figure 29. % Overshoot vs. Cap Load

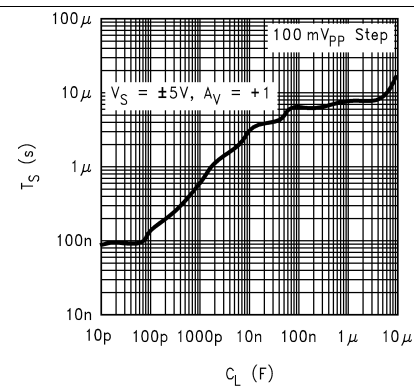

Figure 30. ±5% Settling Time vs. Cap Load

Typical Characteristics (continued)

T_A = 25°C, Unless Otherwise Noted

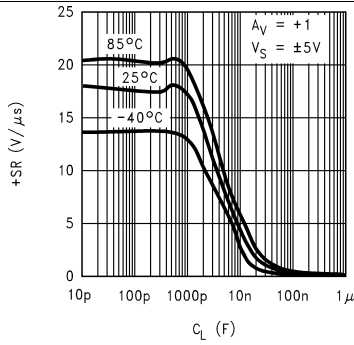

Figure 31. +SR vs. Cap Load

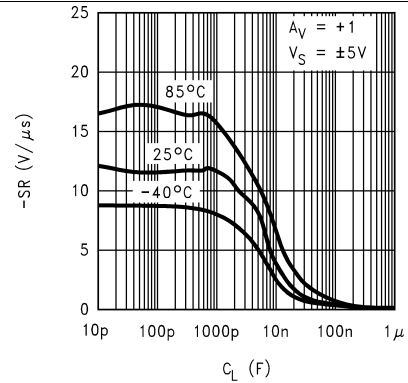

Figure 32. -SR vs. Cap Load

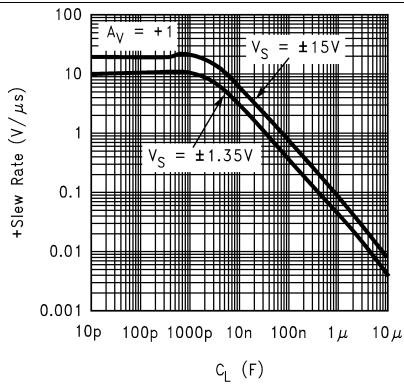

Figure 33. +SR vs. Cap Load

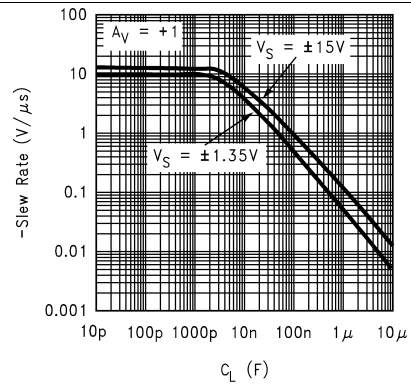

Figure 34. -SR vs. Cap Load

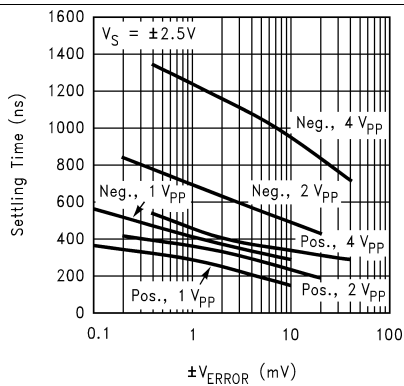

Figure 35. Settling Time vs. Error Voltage

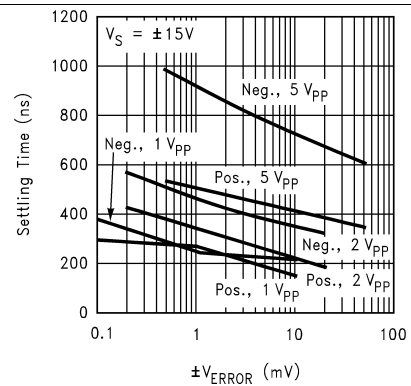

Figure 36. Settling Time vs. Error Voltage

Typical Characteristics (continued)

T_A = 25°C, Unless Otherwise Noted

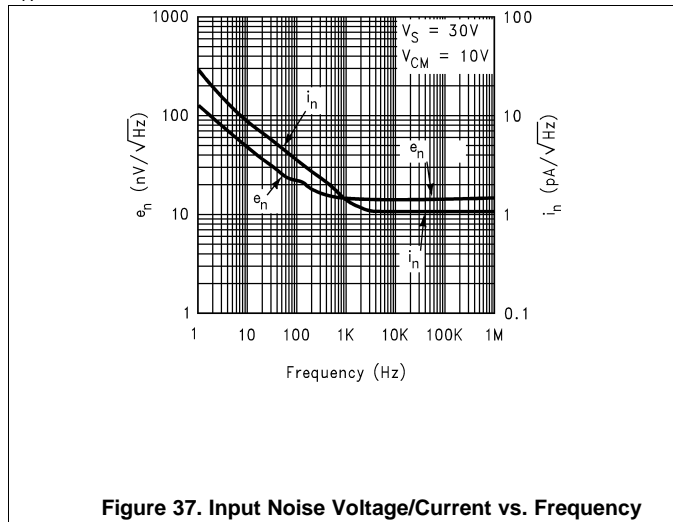

Figure 37. Input Noise Voltage/Current vs. Frequency

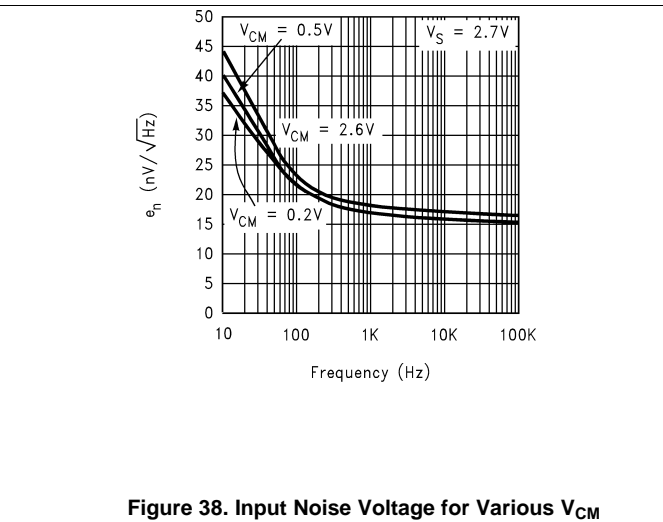

Figure 38. Input Noise Voltage for Various V_{CM}

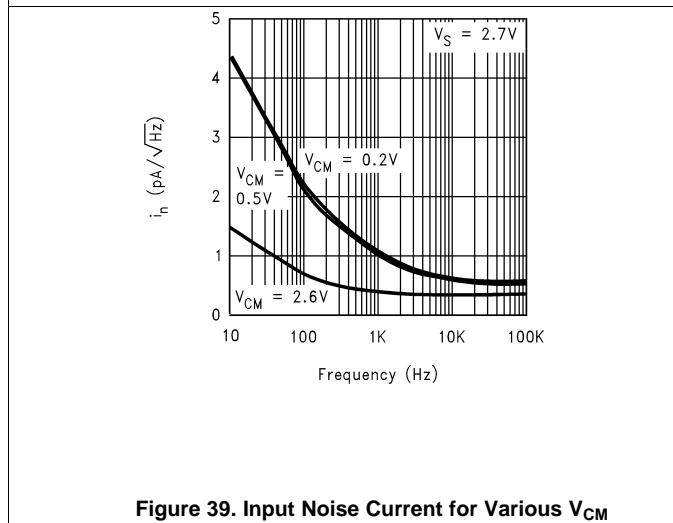

Figure 39. Input Noise Current for Various V_{CM}

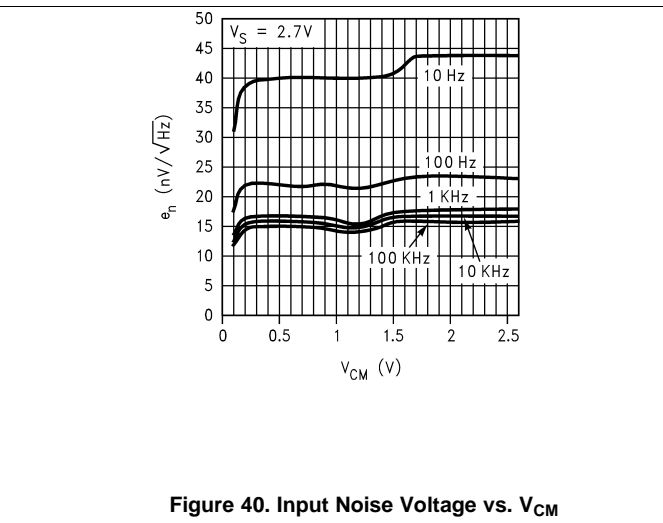

Figure 40. Input Noise Voltage vs. V_{CM}

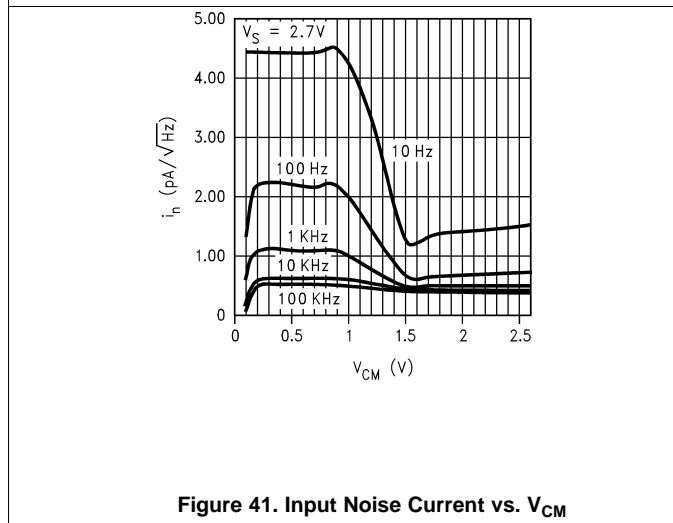

Figure 41. Input Noise Current vs. V_{CM}

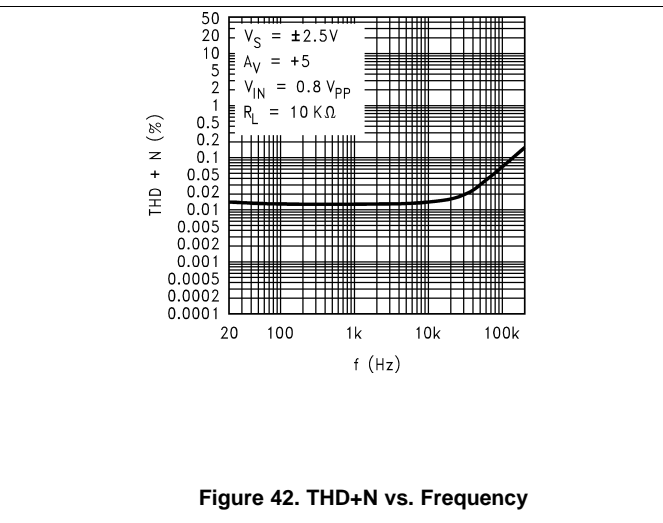

Figure 42. THD+N vs. Frequency

Typical Characteristics (continued)

T_A = 25°C, Unless Otherwise Noted

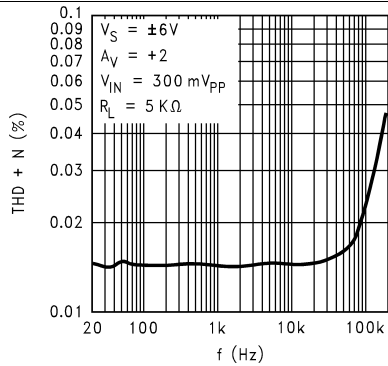

Figure 43. THD+N vs. Frequency

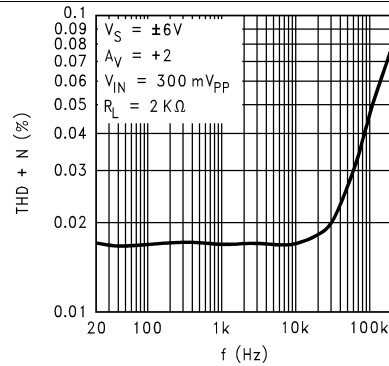

Figure 44. THD+N vs. Frequency

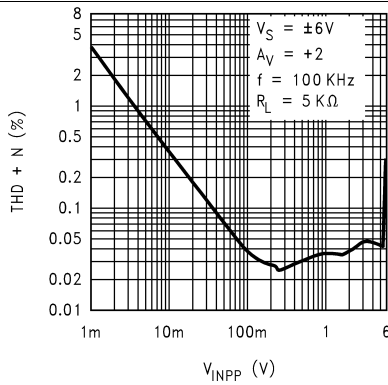

Figure 45. THD+N vs. Amplitude

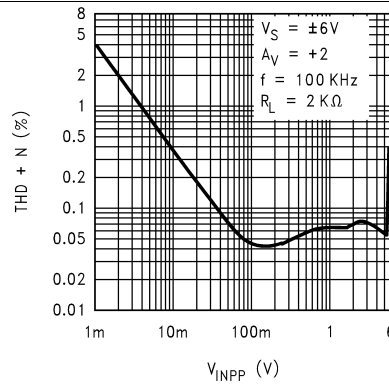

Figure 46. THD+N vs. Amplitude

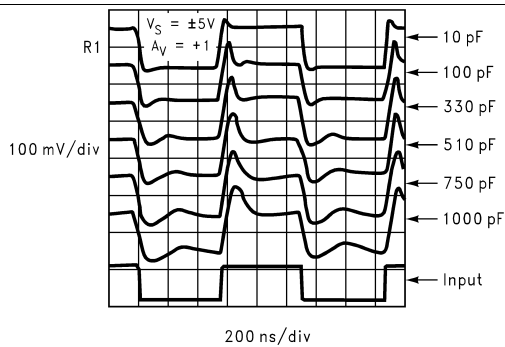

Figure 47. Small Signal Step Response

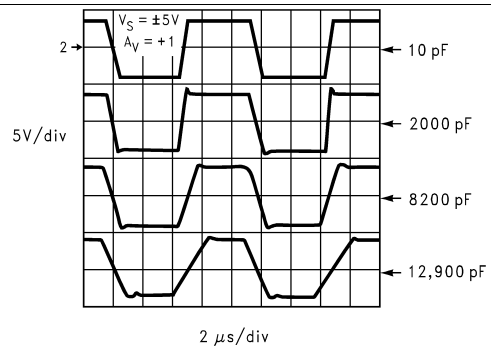

Figure 48. Large Signal Step Response

7 Application and Implementation

7.1 Block Diagram and Operational Description

7.1.1 A) Input Stage

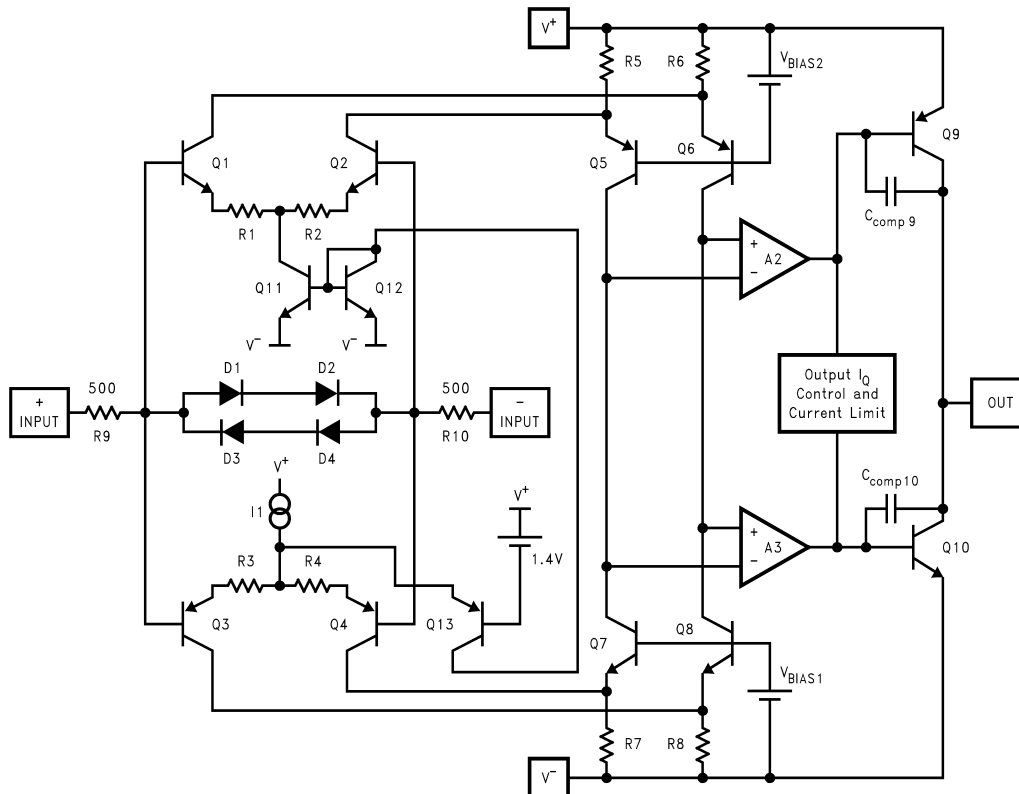

Figure 49. Simplified Schematic Diagram

As seen in Figure 49, the input stage consists of two distinct differential pairs (Q1-Q2 and Q3-Q4) in order to accommodate the full Rail-to-Rail input common mode voltage range. The voltage drop across R5, R6, R7, and R8 is kept to less than 200 mV in order to allow the input to exceed the supply rails. Q13 acts as a switch to steer current away from Q3-Q4 and into Q1-Q2, as the input increases beyond 1.4 V of V^+ . This in turn shifts the signal path from the bottom stage differential pair to the top one and causes a subsequent increase in the supply current.

In transitioning from one stage to another, certain input stage parameters (V_{OS} , I_b , I_{OS} , e_n , and i_n) are determined based on which differential pair is "on" at the time. Input Bias current, I_B , will change in value and polarity as the input crosses the transition region. In addition, parameters such as PSRR and CMRR which involve the input offset voltage will also be effected by changes in V_{CM} across the differential pair transition region.

The input stage is protected with the combination of R9-R10 and D1, D2, D3, and D4 against differential input over-voltages. This fault condition could otherwise harm the differential pairs or cause offset voltage shift in case of prolonged over voltage. As shown in Figure 50, if this voltage reaches approximately ± 1.4 V at 25°C, the diodes turn on and current flow is limited by the internal series resistors (R9 and R10). The Absolute Maximum Rating of ± 10 V differential on V_{IN} still needs to be observed. With temperature variation, the point where the diodes turn on will change at the rate of 5 mV/°C.

Block Diagram and Operational Description (continued)

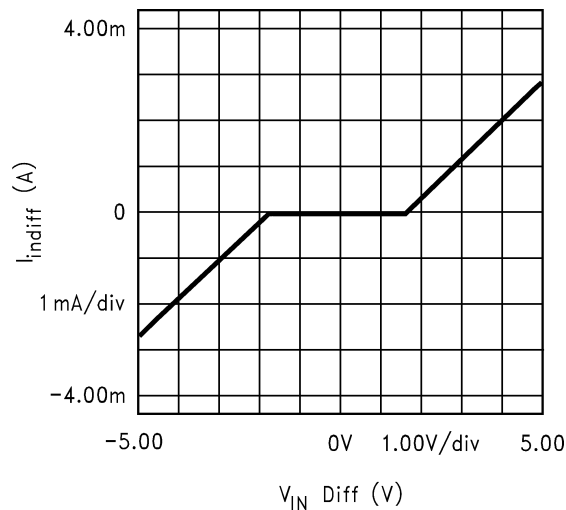

Figure 50. Input Stage Current vs. Differential Input Voltage

7.1.2 B) Output Stage

The output stage [Figure 49](#) is comprised of complementary NPN and PNP common-emitter stages to permit voltage swing to within a $V_{CE(SAT)}$ of either supply rail. Q9 supplies the sourcing and Q10 supplies the sinking current load. Output current limiting is achieved by limiting the V_{CE} of Q9 and Q10; using this approach to current limiting, alleviates the draw back to the conventional scheme which requires one V_{BE} reduction in output swing.

The frequency compensation circuit includes Miller capacitors from collector to base of each output transistor (see [Figure 49](#), C_{comp9} and C_{comp10}). At light capacitive loads, the high frequency gain of the output transistors is high, and the Miller effect increases the effective value of the capacitors thereby stabilizing the Op Amp. Large capacitive loads greatly decrease the high frequency gain of the output transistors thus lowering the effective internal Miller capacitance - the internal pole frequency increases at the same time a low frequency pole is created at the Op Amp output due to the large load capacitor. In this fashion, the internal dominant pole compensation, which works by reducing the loop gain to less than 0dB when the phase shift around the feedback loop is more than 180°, varies with the amount of capacitive load and becomes less dominant when the load capacitor has increased enough. Hence the Op Amp is very stable even at high values of load capacitance resulting in the uncharacteristic feature of stability under all capacitive loads.

7.2 Driving Capacitive Loads

The LM8261 is specifically designed to drive unlimited capacitive loads without oscillations (See [Figure 30](#)). In addition, the output current handling capability of the device allows for good slewing characteristics even with large capacitive loads (see Slew Rate vs. Cap Load plots, [Figure 31](#) through [Figure 34](#)). The combination of these features is ideal for applications such as TFT flat panel buffers, A/D converter input amplifiers, and so forth.

However, as in most Op Amps, addition of a series isolation resistor between the Op Amp and the capacitive load improves the settling and overshoot performance.

Output current drive is an important parameter when driving capacitive loads. This parameter will determine how fast the output voltage can change. Referring to the Slew Rate vs. Cap Load Plots ([Figure 31](#) through [Figure 34](#)), two distinct regions can be identified. Below about 10,000pF, the output Slew Rate is solely determined by the Op Amp's compensation capacitor value and available current into that capacitor. Beyond 10nF, the Slew Rate is determined by the Op Amp's available output current. Note that because of the lower output sourcing current compared to the sinking one, the Slew Rate limit under heavy capacitive loading is determined by the positive transitions. An estimate of positive and negative slew rates for loads larger than 100nF can be made by dividing the short circuit current value by the capacitor.

Driving Capacitive Loads (continued)

For the LM8261, the available output current increases with the input overdrive. As seen in Figure 51 and Figure 52, both sourcing and sinking short circuit current increase as input overdrive increases. In a closed loop amplifier configuration, during transient conditions while the fed back output has not quite caught up with the input, there will be an overdrive imposed on the input allowing more output current than would normally be available under steady state condition. Because of this feature, the Op Amp's output stage quiescent current can be kept to a minimum, thereby reducing power consumption, while enabling the device to deliver large output current when the need arises (such as during transients).

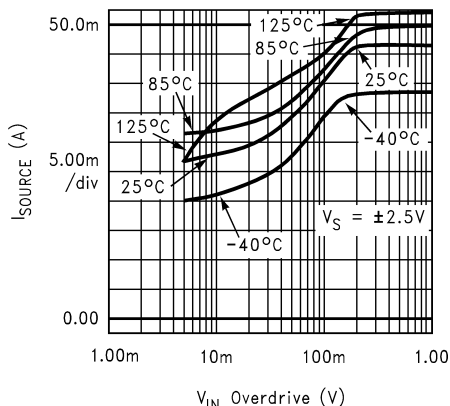

Figure 51. Output Short Circuit Sourcing Current vs. Input Overdrive

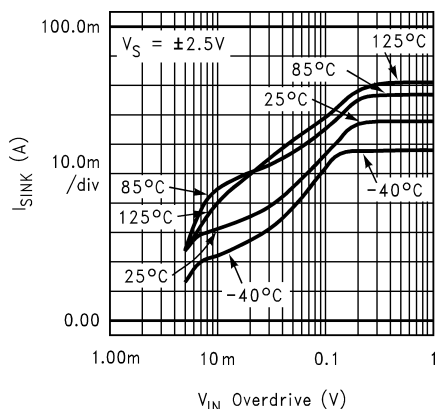

Figure 52. Output Short Circuit Sinking Current vs. Input Overdrive

Driving Capacitive Loads (continued)

Figure 53 shows the output voltage, output current, and the resulting input overdrive with the device set for $A_V = +1$ and the input tied to a $1V_{PP}$ step function driving a $47nF$ capacitor. During the output transition, the input overdrive reaches $1V$ peak and is more than enough to cause the output current to increase to its maximum value (see Figure 51 and Figure 52). Because the larger output sinking current is compared to the sourcing one, the output negative transition is faster than the positive one.

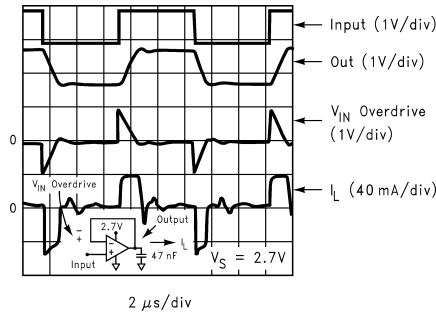

Figure 53. Buffer Amplifier Scope Photo

7.3 Estimating the Output Voltage Swing

It is important to keep in mind that the steady state output current will be less than the current available when there is an input overdrive present. For steady state conditions, Figure 24 through Figure 26 in *Typical Characteristics* can be used to predict the output swing. Figure 54 and Figure 55 show this performance along with several load lines corresponding to loads tied between the output and ground. In each case, the intersection of the device plot at the appropriate temperature with the load line would be the typical output swing possible for that load. For example, a $1-K\Omega$ load can accommodate an output swing to within $250mV$ of V^- and to $330mV$ of V^+ ($V_S = \pm 15V$) corresponding to a typical $29.3V_{PP}$ unclipped swing.

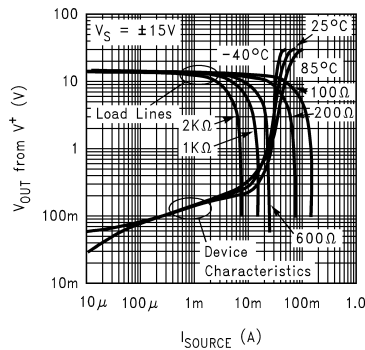

Figure 54. Output Sourcing Characteristics with Load Lines

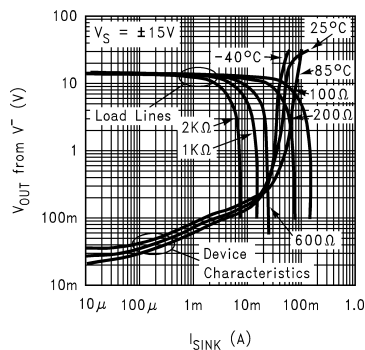

Figure 55. Output Sinking Characteristics with Load Lines

7.4 TFT Applications

Figure 56 below, shows a typical application where the LM8261 is used as a buffer amplifier for the V_{COM} signal employed in a TFT LCD flat panel:

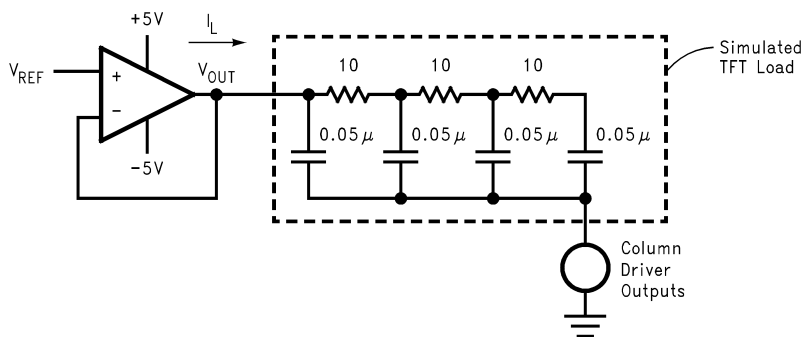

Figure 56. V_{COM} Driver Application Schematic

Figure 57 shows the time domain response of the amplifier when used as a V_{COM} buffer/driver with V_{REF} at ground. In this application, the Op Amp loop will try and maintain its output voltage based on the voltage on its non-inverting input (V_{REF}) despite the current injected into the TFT simulated load. As long as this load current is within the range tolerable by the LM8261 (45 mA sourcing and 65 mA sinking for ± 5 V supplies), the output will settle to its final value within less than 2 μ s.

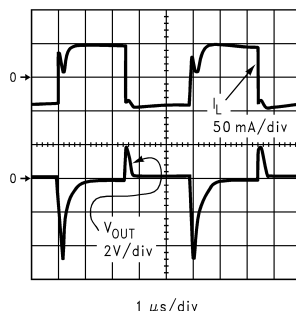

Figure 57. V_{COM} Driver Performance Scope Photo

7.5 Output Short Circuit Current and Dissipation Issues

The LM8261 output stage is designed for maximum output current capability. Even though momentary output shorts to ground and either supply can be tolerated at all operating voltages, longer lasting short conditions can cause the junction temperature to rise beyond the absolute maximum rating of the device, especially at higher supply voltage conditions. Below supply voltage of 6 V, output short circuit condition can be tolerated indefinitely.

With the Op Amp tied to a load, the device power dissipation consists of the quiescent power due to the supply current flow into the device, in addition to power dissipation due to the load current. The load portion of the power itself could include an average value (due to a DC load current) and an AC component. DC load current would flow if there is an output voltage offset, or the output AC average current is non-zero, or if the Op Amp operates in a single supply application where the output is maintained somewhere in the range of linear operation. Therefore:

$$P_{TOTAL} = P_Q + P_{DC} + P_{AC} \quad (1)$$

Op Amp Quiescent Power Dissipation:

$$P_Q = I_S \cdot V_S \quad (2)$$

DC Load Power:

$$P_{DC} = I_O \cdot (V_R - V_O) \quad (3)$$

AC Load Power:

$$P_{AC} = \text{(outlined in table below)}$$

Output Short Circuit Current and Dissipation Issues (continued)

where

- I_S is Supply Current
 - V_S is Total Supply Voltage ($V^+ - V^-$)
 - I_O is Average Load Current
 - V_O is Average Output Voltage
 - V_R is V^+ for sourcing and V^- for sinking current
- (4)

Table 1 shows the maximum AC component of the load power dissipated by the Op Amp for standard Sinusoidal, Triangular, and Square Waveforms:

Table 1. Normalized AC Power Dissipated in the Output Stage for Standard Waveforms

| $P_{AC} (W.\Omega V^2)$ | | |
|-------------------------|-----------------------|-----------------------|
| Sinusoidal | Triangular | Square |
| 50.7×10^{-3} | 46.9×10^{-3} | 62.5×10^{-3} |

The table entries are normalized to V_S^2 / R_L . To calculate the AC load current component of power dissipation, simply multiply the table entry corresponding to the output waveform by the factor V_S^2 / R_L . For example, with ± 15 V supplies, a 600- Ω load, and triangular waveform power dissipation in the output stage is calculated as:

$$P_{AC} = (46.9 \times 10^{-3}) \cdot [30^2 / 600] = 70.4 \text{ mW} \quad (5)$$

7.6 Other Application Hints

The use of supply decoupling is mandatory in most applications. As with most relatively high speed/high output current Op Amps, best results are achieved when each supply line is decoupled with two capacitors; a small value ceramic capacitor ($\sim 0.01 \mu\text{F}$) placed very close to the supply lead in addition to a large value Tantalum or Aluminum ($> 4.7 \mu\text{F}$). The large capacitor can be shared by more than one device if necessary. The small ceramic capacitor maintains low supply impedance at high frequencies while the large capacitor will act as the charge "bucket" for fast load current spikes at the Op Amp output. The combination of these capacitors will provide supply decoupling and will help keep the Op Amp oscillation free under any load.

7.6.1 LM8261 Advantages

Compared to other Rail-to-Rail Input/Output devices, the LM8261 offers several advantages such as:

- Improved cross over distortion.
- Nearly constant supply current throughout the output voltage swing range and close to either rail.
- Consistent stability performance for all input/output voltage and current conditions.
- Nearly constant Unity gain frequency (f_u) and Phase Margin (Φ_{m}) for all operating supplies and load conditions.
- No output phase reversal under input overload condition.

8 Power Supply Recommendations

The LM8261 can operate off a single supply or with dual supplies. The input CM capability of the parts (CMVR) extends covers the entire supply voltage range for maximum flexibility. Supplies should be decoupled with low inductance, often ceramic, capacitors to ground less than 0.5 inches from the device pins. The use of ground plane is recommended, and as in most high speed devices, it is advisable to remove ground plane close to device sensitive pins such as the inputs.

9 Layout

9.1 Layout Guidelines

Generally, a good high frequency layout will keep power supply and ground traces away from the inverting input and output pins. Parasitic capacitances on these nodes to ground will cause frequency response peaking and possible circuit oscillations. Texas Instruments suggests the following evaluation boards as a guide for high frequency layout and as an aid in device testing and characterization. See [Table 2](#) for details. The LM8261 evaluation board(s) is a good example of high frequency layout techniques as a reference. General high-speed, signal-path layout suggestions include:

- Continuous ground planes are preferred for signal routing with matched impedance traces for longer runs. However, open up both ground and power planes around the capacitive sensitive input and output device pins as shown in [Figure 58](#). After the signal is sent into a resistor, parasitic capacitance becomes more of a bandlimiting issue and less of a stability issue.
- Use good, high-frequency decoupling capacitors (0.1 μF) on the ground plane at the device power pins as shown in [Figure 58](#). Higher value capacitors (2.2 μF) are required, but may be placed further from the device power pins and shared among devices. For best high-frequency decoupling, consider X2Y supply-decoupling capacitors that offer a much higher self-resonance frequency over standard capacitors.
- When using differential signal routing over any appreciable distance, use microstrip layout techniques with matched impedance traces.
- The input summing junction is very sensitive to parasitic capacitance. Connect any R_f , and R_g elements into the summing junction with minimal trace length to the device pin side of the resistor, as shown in [Figure 59](#). The other side of these elements can have more trace length if needed to the source or to ground.

9.2 Layout Example

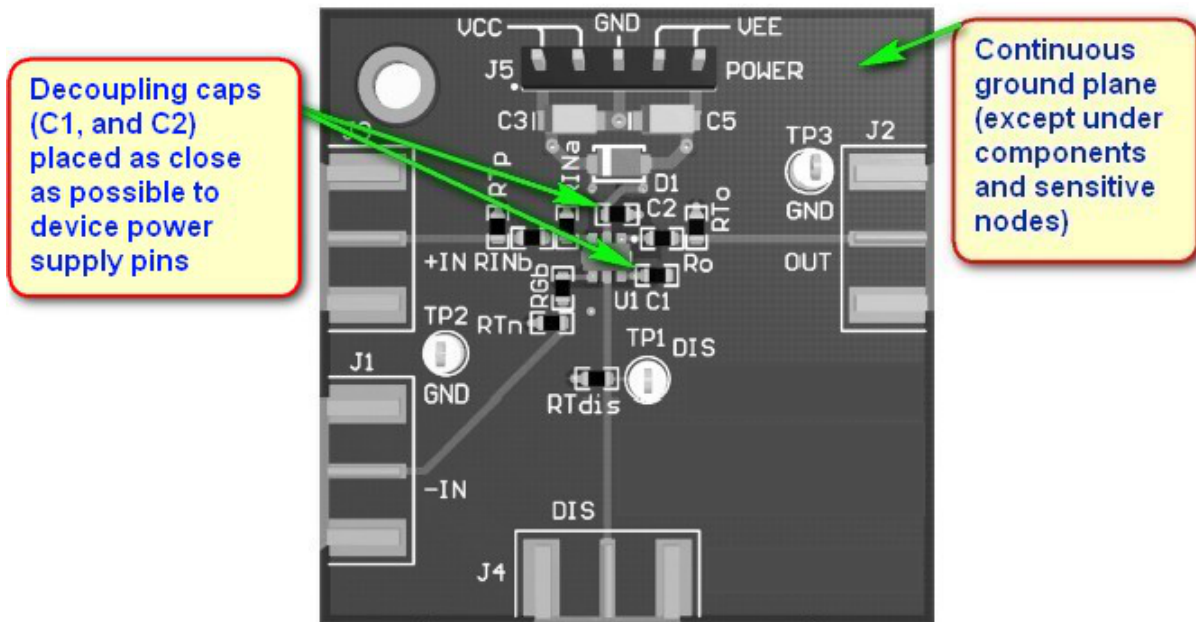

Figure 58. LM8261 Evaluation Board Layer 1

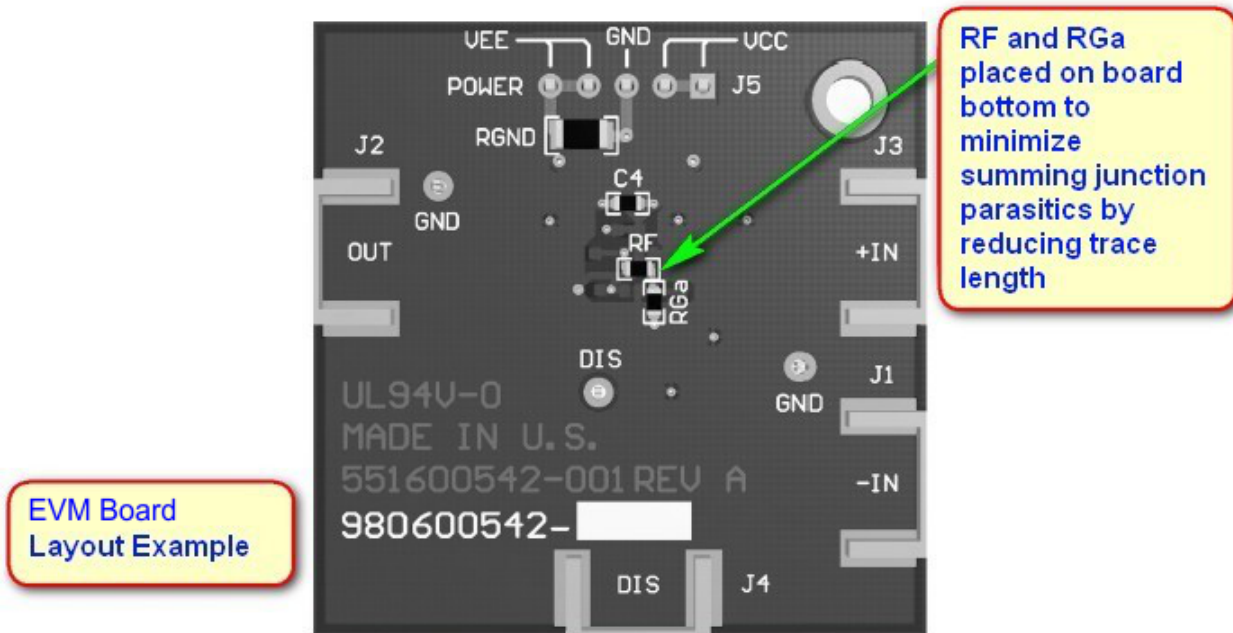

Figure 59. LM8261 Evaluation Board Layer 2

Table 2. Evaluation Board Comparison

| DEVICE | PACKAGE | EVALUATION BOARD PART NUMBER |
|----------|---------|------------------------------|
| LM8261M5 | SOT-23 | LMH730216 |

10 Device and Documentation Support

10.1 Documentation Support

10.1.1 Related Documentation

For related documentation, see *IC Package Thermal Metrics* Application Report, [SPRA953](#)

10.2 Trademarks

All trademarks are the property of their respective owners.

10.3 Electrostatic Discharge Caution



These devices have limited built-in ESD protection. The leads should be shorted together or the device placed in conductive foam during storage or handling to prevent electrostatic damage to the MOS gates.

10.4 Glossary

[SLYZ022](#) — *TI Glossary*.

This glossary lists and explains terms, acronyms, and definitions.

11 Mechanical, Packaging, and Orderable Information

The following pages include mechanical, packaging, and orderable information. This information is the most current data available for the designated devices. This data is subject to change without notice and revision of this document. For browser-based versions of this data sheet, refer to the left-hand navigation.

PACKAGING INFORMATION

| Orderable Device | Status (1) | Package Type | Package Drawing | Pins | Package Qty | Eco Plan (2) | Lead/Ball Finish (6) | MSL Peak Temp (3) | Op Temp (°C) | Device Marking (4/5) | Samples |
|------------------|---------------|--------------|-----------------|------|-------------|-------------------------|-------------------------|----------------------|--------------|-------------------------|----------------|
| LM8261M5 | NRND | SOT-23 | DBV | 5 | 1000 | TBD | Call TI | Call TI | -40 to 85 | A45A | |
| LM8261M5/NOPB | ACTIVE | SOT-23 | DBV | 5 | 1000 | Green (RoHS & no Sb/Br) | CU SN | Level-1-260C-UNLIM | -40 to 85 | A45A | Samples |
| LM8261M5X | NRND | SOT-23 | DBV | 5 | 3000 | TBD | Call TI | Call TI | -40 to 85 | A45A | |
| LM8261M5X/NOPB | ACTIVE | SOT-23 | DBV | 5 | 3000 | Green (RoHS & no Sb/Br) | CU SN | Level-1-260C-UNLIM | -40 to 85 | A45A | Samples |

(1) The marketing status values are defined as follows:

ACTIVE: Product device recommended for new designs.

LIFEBUY: TI has announced that the device will be discontinued, and a lifetime-buy period is in effect.

NRND: Not recommended for new designs. Device is in production to support existing customers, but TI does not recommend using this part in a new design.

PREVIEW: Device has been announced but is not in production. Samples may or may not be available.

OBSELETE: TI has discontinued the production of the device.

(2) Eco Plan - The planned eco-friendly classification: Pb-Free (RoHS), Pb-Free (RoHS Exempt), or Green (RoHS & no Sb/Br) - please check <http://www.ti.com/productcontent> for the latest availability information and additional product content details.

TBD: The Pb-Free/Green conversion plan has not been defined.

Pb-Free (RoHS): TI's terms "Lead-Free" or "Pb-Free" mean semiconductor products that are compatible with the current RoHS requirements for all 6 substances, including the requirement that lead not exceed 0.1% by weight in homogeneous materials. Where designed to be soldered at high temperatures, TI Pb-Free products are suitable for use in specified lead-free processes.

Pb-Free (RoHS Exempt): This component has a RoHS exemption for either 1) lead-based flip-chip solder bumps used between the die and package, or 2) lead-based die adhesive used between the die and leadframe. The component is otherwise considered Pb-Free (RoHS compatible) as defined above.

Green (RoHS & no Sb/Br): TI defines "Green" to mean Pb-Free (RoHS compatible), and free of Bromine (Br) and Antimony (Sb) based flame retardants (Br or Sb do not exceed 0.1% by weight in homogeneous material)

(3) MSL, Peak Temp. - The Moisture Sensitivity Level rating according to the JEDEC industry standard classifications, and peak solder temperature.

(4) There may be additional marking, which relates to the logo, the lot trace code information, or the environmental category on the device.

(5) Multiple Device Markings will be inside parentheses. Only one Device Marking contained in parentheses and separated by a "~" will appear on a device. If a line is indented then it is a continuation of the previous line and the two combined represent the entire Device Marking for that device.

(6) Lead/Ball Finish - Orderable Devices may have multiple material finish options. Finish options are separated by a vertical ruled line. Lead/Ball Finish values may wrap to two lines if the finish value exceeds the maximum column width.

Important Information and Disclaimer: The information provided on this page represents TI's knowledge and belief as of the date that it is provided. TI bases its knowledge and belief on information provided by third parties, and makes no representation or warranty as to the accuracy of such information. Efforts are underway to better integrate information from third parties. TI has taken and

continues to take reasonable steps to provide representative and accurate information but may not have conducted destructive testing or chemical analysis on incoming materials and chemicals. TI and TI suppliers consider certain information to be proprietary, and thus CAS numbers and other limited information may not be available for release.

In no event shall TI's liability arising out of such information exceed the total purchase price of the TI part(s) at issue in this document sold by TI to Customer on an annual basis.

TAPE AND REEL INFORMATION

QUADRANT ASSIGNMENTS FOR PIN 1 ORIENTATION IN TAPE

*All dimensions are nominal

| Device | Package Type | Package Drawing | Pins | SPQ | Reel Diameter (mm) | Reel Width W1 (mm) | A0 (mm) | B0 (mm) | K0 (mm) | P1 (mm) | W (mm) | Pin1 Quadrant |
|----------------|--------------|-----------------|------|------|--------------------|--------------------|---------|---------|---------|---------|--------|---------------|
| LM8261M5 | SOT-23 | DBV | 5 | 1000 | 178.0 | 8.4 | 3.2 | 3.2 | 1.4 | 4.0 | 8.0 | Q3 |
| LM8261M5/NOPB | SOT-23 | DBV | 5 | 1000 | 178.0 | 8.4 | 3.2 | 3.2 | 1.4 | 4.0 | 8.0 | Q3 |
| LM8261M5X | SOT-23 | DBV | 5 | 3000 | 178.0 | 8.4 | 3.2 | 3.2 | 1.4 | 4.0 | 8.0 | Q3 |
| LM8261M5X/NOPB | SOT-23 | DBV | 5 | 3000 | 178.0 | 8.4 | 3.2 | 3.2 | 1.4 | 4.0 | 8.0 | Q3 |

TAPE AND REEL BOX DIMENSIONS

*All dimensions are nominal

| Device | Package Type | Package Drawing | Pins | SPQ | Length (mm) | Width (mm) | Height (mm) |
|----------------|--------------|-----------------|------|------|-------------|------------|-------------|
| LM8261M5 | SOT-23 | DBV | 5 | 1000 | 210.0 | 185.0 | 35.0 |
| LM8261M5/NOPB | SOT-23 | DBV | 5 | 1000 | 210.0 | 185.0 | 35.0 |
| LM8261M5X | SOT-23 | DBV | 5 | 3000 | 210.0 | 185.0 | 35.0 |
| LM8261M5X/NOPB | SOT-23 | DBV | 5 | 3000 | 210.0 | 185.0 | 35.0 |

DBV (R-PDSO-G5)

PLASTIC SMALL-OUTLINE PACKAGE



- NOTES:
- A. All linear dimensions are in millimeters.
 - B. This drawing is subject to change without notice.
 - C. Body dimensions do not include mold flash or protrusion. Mold flash and protrusion shall not exceed 0.15 per side.
 - D. Falls within JEDEC MO-178 Variation AA.

DBV (R-PDSO-G5)

PLASTIC SMALL OUTLINE



- NOTES:
- A. All linear dimensions are in millimeters.
 - B. This drawing is subject to change without notice.
 - C. Customers should place a note on the circuit board fabrication drawing not to alter the center solder mask defined pad.
 - D. Publication IPC-7351 is recommended for alternate designs.
 - E. Laser cutting apertures with trapezoidal walls and also rounding corners will offer better paste release. Customers should contact their board assembly site for stencil design recommendations. Example stencil design based on a 50% volumetric metal load solder paste. Refer to IPC-7525 for other stencil recommendations.

IMPORTANT NOTICE

Texas Instruments Incorporated and its subsidiaries (TI) reserve the right to make corrections, enhancements, improvements and other changes to its semiconductor products and services per JESD46, latest issue, and to discontinue any product or service per JESD48, latest issue. Buyers should obtain the latest relevant information before placing orders and should verify that such information is current and complete. All semiconductor products (also referred to herein as "components") are sold subject to TI's terms and conditions of sale supplied at the time of order acknowledgment.

TI warrants performance of its components to the specifications applicable at the time of sale, in accordance with the warranty in TI's terms and conditions of sale of semiconductor products. Testing and other quality control techniques are used to the extent TI deems necessary to support this warranty. Except where mandated by applicable law, testing of all parameters of each component is not necessarily performed.

TI assumes no liability for applications assistance or the design of Buyers' products. Buyers are responsible for their products and applications using TI components. To minimize the risks associated with Buyers' products and applications, Buyers should provide adequate design and operating safeguards.

TI does not warrant or represent that any license, either express or implied, is granted under any patent right, copyright, mask work right, or other intellectual property right relating to any combination, machine, or process in which TI components or services are used. Information published by TI regarding third-party products or services does not constitute a license to use such products or services or a warranty or endorsement thereof. Use of such information may require a license from a third party under the patents or other intellectual property of the third party, or a license from TI under the patents or other intellectual property of TI.

Reproduction of significant portions of TI information in TI data books or data sheets is permissible only if reproduction is without alteration and is accompanied by all associated warranties, conditions, limitations, and notices. TI is not responsible or liable for such altered documentation. Information of third parties may be subject to additional restrictions.

Resale of TI components or services with statements different from or beyond the parameters stated by TI for that component or service voids all express and any implied warranties for the associated TI component or service and is an unfair and deceptive business practice. TI is not responsible or liable for any such statements.

Buyer acknowledges and agrees that it is solely responsible for compliance with all legal, regulatory and safety-related requirements concerning its products, and any use of TI components in its applications, notwithstanding any applications-related information or support that may be provided by TI. Buyer represents and agrees that it has all the necessary expertise to create and implement safeguards which anticipate dangerous consequences of failures, monitor failures and their consequences, lessen the likelihood of failures that might cause harm and take appropriate remedial actions. Buyer will fully indemnify TI and its representatives against any damages arising out of the use of any TI components in safety-critical applications.

In some cases, TI components may be promoted specifically to facilitate safety-related applications. With such components, TI's goal is to help enable customers to design and create their own end-product solutions that meet applicable functional safety standards and requirements. Nonetheless, such components are subject to these terms.

No TI components are authorized for use in FDA Class III (or similar life-critical medical equipment) unless authorized officers of the parties have executed a special agreement specifically governing such use.

Only those TI components which TI has specifically designated as military grade or "enhanced plastic" are designed and intended for use in military/aerospace applications or environments. Buyer acknowledges and agrees that any military or aerospace use of TI components which have **not** been so designated is solely at the Buyer's risk, and that Buyer is solely responsible for compliance with all legal and regulatory requirements in connection with such use.

TI has specifically designated certain components as meeting ISO/TS16949 requirements, mainly for automotive use. In any case of use of non-designated products, TI will not be responsible for any failure to meet ISO/TS16949.

Products

| | |
|------------------------------|--|
| Audio | www.ti.com/audio |
| Amplifiers | amplifier.ti.com |
| Data Converters | dataconverter.ti.com |
| DLP® Products | www.dlp.com |
| DSP | dsp.ti.com |
| Clocks and Timers | www.ti.com/clocks |
| Interface | interface.ti.com |
| Logic | logic.ti.com |
| Power Mgmt | power.ti.com |
| Microcontrollers | microcontroller.ti.com |
| RFID | www.ti-rfid.com |
| OMAP Applications Processors | www.ti.com/omap |
| Wireless Connectivity | www.ti.com/wirelessconnectivity |

Applications

| | |
|-------------------------------|--|
| Automotive and Transportation | www.ti.com/automotive |
| Communications and Telecom | www.ti.com/communications |
| Computers and Peripherals | www.ti.com/computers |
| Consumer Electronics | www.ti.com/consumer-apps |
| Energy and Lighting | www.ti.com/energy |
| Industrial | www.ti.com/industrial |
| Medical | www.ti.com/medical |
| Security | www.ti.com/security |
| Space, Avionics and Defense | www.ti.com/space-avionics-defense |
| Video and Imaging | www.ti.com/video |

TI E2E Community

e2e.ti.com