

# PLASTIC R SERIES CONNECTORS

**R** SERIES



**LEMO**

## Table of Contents

General Production Program .....	page 2
Main Characteristics and Types .....	2
Series and Types .....	3
LEMO's Push-Pull Self-Latching Connection System .....	4
R Series Production Program .....	4
Series and Contact configuration .....	4
R Series Section .....	5
Interconnections .....	6
Model Description .....	6
Part Number Example .....	7
Part Selection Showing Internal Components .....	7
Housing Models .....	8-9
Alignment Key and Polarized Keying System .....	10
Crimp Contacts .....	11
Mixed Hybrid Overview .....	12
Inserts Multipole .....	13
Mixed High Voltage + Low Voltage .....	14-15
Mixed Coax & Low Voltage .....	16-17
Mixed Fluidic & Low Voltage .....	18
Fluidic/Pneumatic Contacts .....	19-20
Housing Colors .....	21
Accessories .....	22-23
Insulators for crimp contacts .....	22-23
Clamping and Bracketing .....	22
Inserts and Crimp contacts .....	23
Tooling .....	24-25
Crimping tools .....	24-25
Positioners for crimp contact .....	24
Extractor for crimp contact .....	25
Panel Cut-Outs .....	26
Mounting .....	26
PCB Drilling Pattern .....	26
Fixed receptacle with straight print contacts .....	26
Technical Characteristics .....	27
Outer Shell .....	27
Insulator .....	27
Electrical contact .....	28
Crimp contacts .....	29

## General Production Program

**Connectors**

- Unipole from 2 to 150 Amps
- Coaxial 50 and 75 Ω
- Coaxial 50 Ω (NIM-CAMAC)
- Coaxial 50 Ω for frequency → 12 GHz
- Multicoaxial 50 and 75 Ω
- Multipole from 2 to 66 contacts
- Multipole up to 106 contacts
- High Voltage 3, 5, 8, 10, 15, 30 and 50 kV cc
- Multi High Voltage 3, 5, and 10 kV cc
- Triaxial 50 and 75 Ω
- Quadrax
- Mixed: High Voltage (HV) + Low Voltage (LV)
- Mixed: Coax + LV
- Mixed: Triax + LV
- Thermocouple
- Multithermocouple
- Fiber optic singlemode
- Fiber optic multimode
- Mixed: fiber optic + LV
- Mixed: fiber optic + coax + LV
- Fluidic
- Multifluidic
- Mixed: fluidic + LV
- Subminiature
- Miniature
- Plastic
- Printed circuit board
- Remote handling
- Watertight
- Sealed (pressure and/or vacuum)
- With plastic outer shell
- With aluminum outer shell
- With stainless steel outer shell
- With special radiation resistant insulator material
- With screw thread coupling for very high pressure
- With microswitch

**Patch Panels**

- For audio-mono applications: triax
- For audio-mono applications: 3 contacts
- For audio-stereo applications: quadrax
- For audio-stereo applications: 6 contacts
- For video applications: coax 75 Ω
- For video HDTV applications: 3 coax 75 Ω + 2LV

**Patch Panels** For fiber optic applications

**Adapters** For BNC, C, UHF, N, CINCH, GEN-RADIO connectors  
For TNC, SMA connectors

**Accessories**

- Insulator for crimp contacts
- Crimp contacts
- Coaxial contacts
- Triaxial contacts
- Fiber optic contacts
- Fiber optic ferrules
- Caps
- Bend relief
- Heatshrink boot
- Insulating washers
- Double plastic panel washers
- Locking washers
- Tapered washers
- Hexagonal nuts
- Conical nuts
- Round nuts
- Notched nuts
- Earthing washers
- Lead-through with cable collet

**Tooling**

- Wrenches
- Assembly tool
- Pliers
- Taps
- Crimping tools
- Positioners
- Crimping dies
- Extractors
- Banding tool
- Retention testing tool for crimp contacts
- Fiber optic termination workstation
- Fiber optic polishing tools

**On request**

- Filtered connectors
- Connectors with special housing
- Mixed special configuration
- Assembly onto cable

● Connectors, accessories and tools found in this catalog.

## Main Characteristics and Types

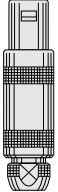
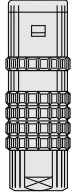
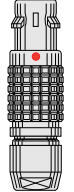
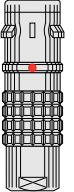
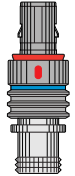
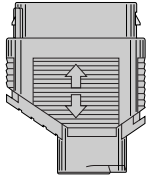
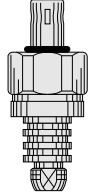
							
<b>Series</b>	<b>STANDARD</b>	<b>WATERTIGHT</b>	<b>KEYED</b>	<b>KEYED WATERTIGHT</b>	<b>HARSH ENVIRONMENTS</b>	<b>RECTANGULAR</b>	<b>SCREW</b>
	01 (Minax)	0E to 6E	00 (multipole)	0K to 5K	FF to 5F	RR / OR / 1R	03
	00 (NIM-CAMAC)	3T	0B to 5B	2N to 5N			0V to 5V
	00 (unipole)	4M	2G / 5G				0W to 5W
	05 / R0						2U to 5U
	0S to 6S						0M-1M-2M
	0A / 4A						
	1D / 2C						
	1Y-3Y-6Y						
<b>Latching</b>	Push-Pull						Screw
<b>Key</b>	Stepped insert (Half-Moon)		Key (G) or other key-way code		Key (N) or other key-way code	Key G or A	Key (G) or stepped insert (Half-Moon)
<b>Shell</b>	Metal or plastic	Metal	Metal or plastic	Metal		Plastic	Metal
<b>Insert</b>	Hermaphroditic or cylindrical		Cylindrical			Rectangular	Hermaphroditic or cylindrical
<b>Contact</b>	Solder or print		Solder, crimp or print		Crimp or print	Crimp or print	Solder (crimp or print)

## Series and Types

	Series	Types																				
		Unipole	Coaxial 50 Ω	Coaxial 75 Ω	Multipole	High Voltage	Triaxial 50 Ω	Triaxial 75 Ω	Quadrax	Multi HV	Multi Coaxial	Mixed HV+LV	Mixed Coax+LV	Mixed Triax+LV	Fiber Optic	Multi FO	Mixed FO+LV	Fluidic	Multi fluidic	Mixed fluidic+LV	Thermocouple	
Standard	01		●																			
	00	●	●				●											●				
	05					●																
	R0		●																			
	0A		●	●																		
	0S	●	●		●	●	●															●
	1S	●	●	●	●	●	●															●
	2S	●	●	●	●	●	●	●														●
	3S	●	●	●	●	●	●	●		●			●	●								
	4S	●	●	●	●	●	●	●		●	●	●	●	●								
	5S	●	●	●	●					●	●	●	●	●								
	6S				●						●		●	●								
	1D								●													
	2C		●		●																	
4A							●															
1Y-3Y-6Y					●																	
Watertight	0E	●	●		●	●	●															●
	1E	●	●	●	●	●	●															●
	2E	●	●	●	●	●	●				●	●	●									●
	3E	●	●	●	●	●	●		●		●	●	●									
	4E	●	●	●	●		●	●			●	●	●									
	5E	●			●					●	●	●	●									
	6E				●						●		●									
	3T			●				●														
4M						●	●															
Keyed	00				●										●							●
	0B				●										●			●				●
	1B				●							●										●
	2B				●				●	●	●	●	●	●			●	●			●	●
	3B				●					●	●	●	●	●		●	●		●	●	●	●
	4B				●				●	●	●	●	●	●		●	●		●	●	●	●
	5B				●				●	●	●	●	●	●		●	●		●	●	●	●
2G				●																		
5G								●														
Keyed watertight	0K				●										●			●				●
	1K				●						●	●	●									●
	2K				●					●	●	●	●	●			●	●				●
	3K			●	●					●	●	●	●	●		●	●		●	●		●
	4K				●				●	●	●	●	●	●		●	●		●	●		●
	5K				●				●	●	●	●	●	●		●	●		●	●		●
	FF to 5F				●																	
2N to 5N				●																		
Rectangular	RR				●							●										
	0R				●						●	●									●	
	1R				●						●	●									●	
Screw	03		●		●																	
	0V	●	●		●		●															●
	1V	●	●	●	●		●															●
	2V	●	●	●	●		●	●				●										●
	3V	●	●	●	●		●	●		●		●	●									
	4V	●	●	●	●		●	●				●	●									
	5V	●			●				●	●	●	●	●									
	0W to 5W				●					●	●	●	●	●			●					●
	2U to 5U				●										●	●	●					●
	0M to 2M				●																	

Note: ● = included in this catalog, ● = available but not included in this catalog.

## LEMO's Push-Pull Self-Latching Connection System

This self-latching system is renowned worldwide for its easy and quick mating and unmating features. It provides absolute security against vibration, shock or pull on the cable, and facilitates operation in a very limited space.

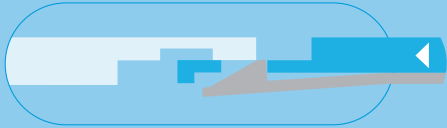
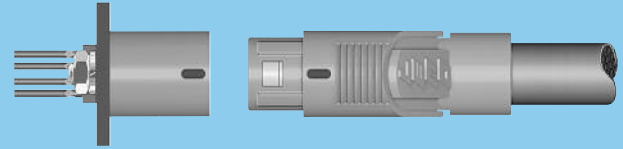

The plug and the receptacle can be mated by simply pushing axially the outer shell of the plug.



Pulling on the cable or any other component of the plug than the outer release sleeve cannot break the connection.

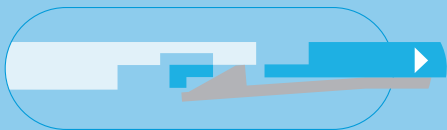

The connector can be unmated by a single axial pull on the plug outer release sleeve.

## R Series Production Program

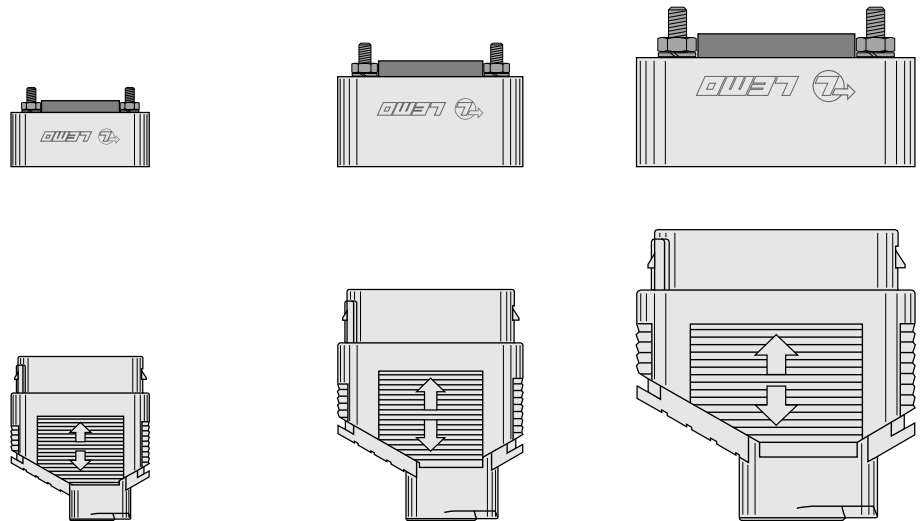

Series		RR	OR	1R
Cable $\phi$ range (mm)	min.	1.0	1.5	2.0
	max.	4.0	6.2	9.2
Number of contacts (multipole)		13	10, 17, 37	28, 36, 67
Number of contacts (mixed HV+LV)		-	4 HV + 4 LV, 2 HV + 13 LV	8 HV + 3 LV
Number of contacts (mixed coax+LV)		1 coax + 4 LV	4 coax + 4 LV, 2 coax + 13 LV	8 coax + 3 LV
Number of contacts (mixed fluidic+LV)		-	4 fluidic + 4 LV, 2 fluidic + 13 LV	8 fluidic + 3 LV

**Note:** «LV» stands for low voltage.

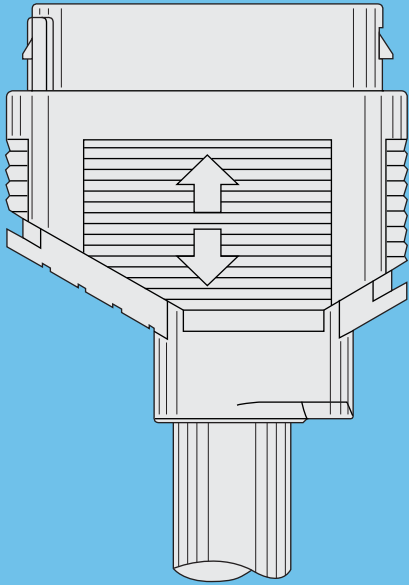
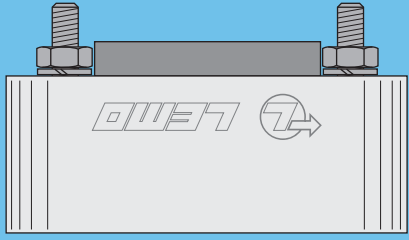

**R SERIES**

# R Series

The R series is a rectangular connector with high pin density in a flat profile. It uses LEMO's well proven Push-Pull latching system for a smooth, hassle free connection. The ergonomic and flat profile offers high panel density, in a wide choice of colors for excellent visual aesthetics.

The R series is made of lightweight polyester resin Crastin® PBT from Dupont™. The high flexibility of its design enables various contact configuration, such as multipole, coaxial, high voltage and fluidic.

R series connectors provide the following main features:

- plastic shell for lightweight yet rugged structure
- push-pull latching enable fast and secure connections
- crimp or printed circuit contacts
- choice of 4 colors for aesthetics and quick identification
- high pin density for improved panel space
- 3 sizes and various models for design choices
- standard or hybrid pin configurations for flexibility
- thin footprint for reduced rack space and high density panel.

The R series, is initially designed to interconnect systems in medical application where aesthetics and safety is required. This connector series can also be used for test & measurement, aerospace and automotive testing, where an extensive number of contacts are needed in a limited space.

Plastic material used for manufacturing insulators is selected according to the required electric and thermal properties. The thermoplastic used is PEEK (Polyether-Etherketone) with the addition of glass fibers to improve mechanical characteristics and to increase dielectric strength.

## Plastic housing models

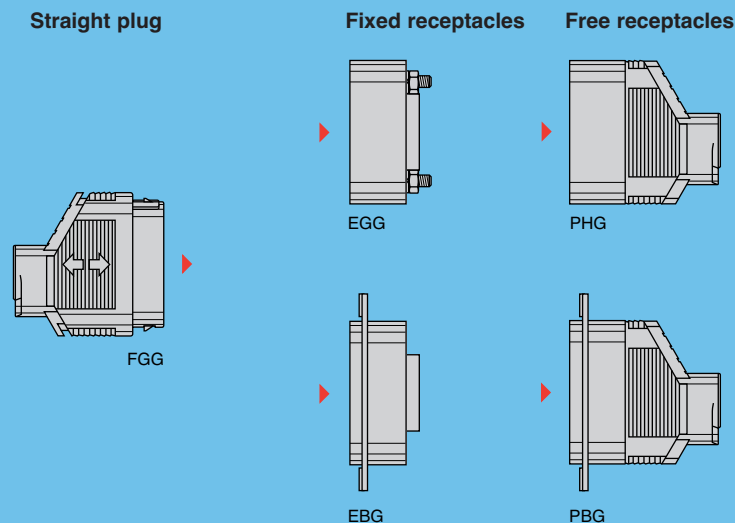

## Part Numbering System

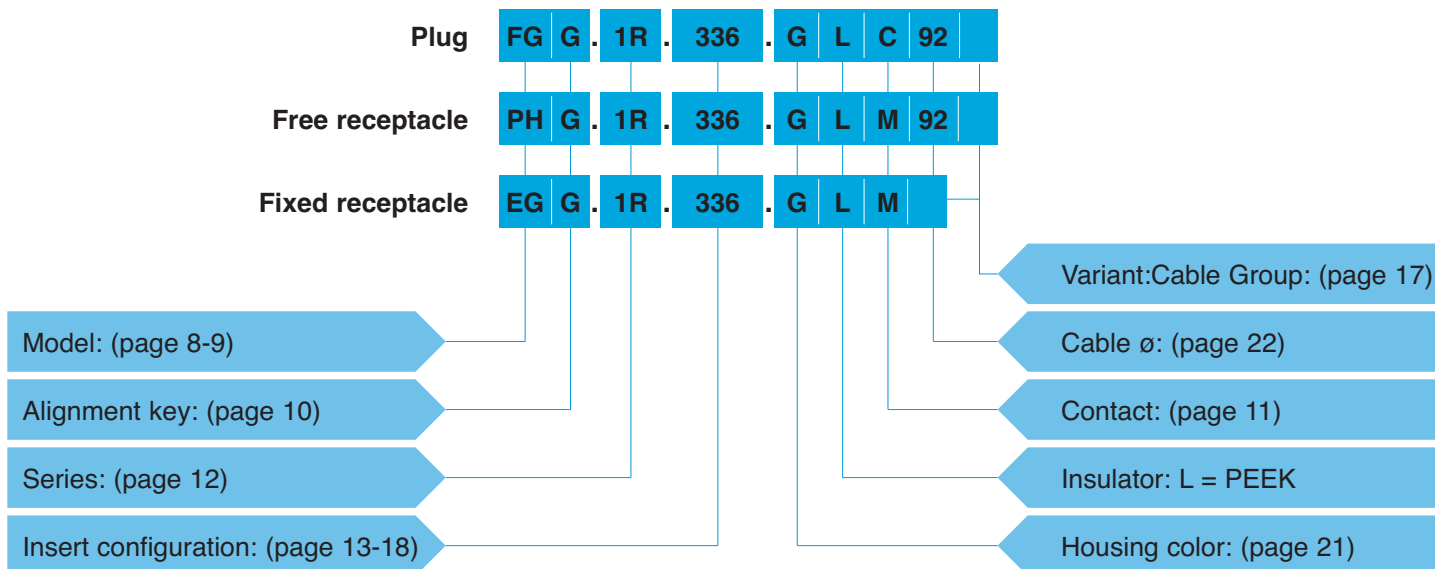

## Part Number Example

### Straight plug with cable collet:

**FGG.1R.336.GLC92** = straight plug with key (G) and cable collet, 1R series, multipole type with 36 contacts, outer shell in gray PBT, PEEK insulator, male crimp contacts, collet for 9.2 mm maximum diameter cable.

### Free receptacle:

**PHG.1R.336.GLM92** = free receptacle with key (G) and cable collet, 1R series, multipole type with 36 contacts, outer shell in gray PBT, PEEK insulator, female crimp contacts, collet for 9.2 mm maximum diameter cable.

### Fixed receptacle:

**EGG.1R.336.GLM** = fixed receptacle, nut fixing, with key (G), 1R series, multipole type with 36 contacts, outer shell in gray PBT, PEEK insulator, female crimp contacts.

## Part Section Showing Internal Components

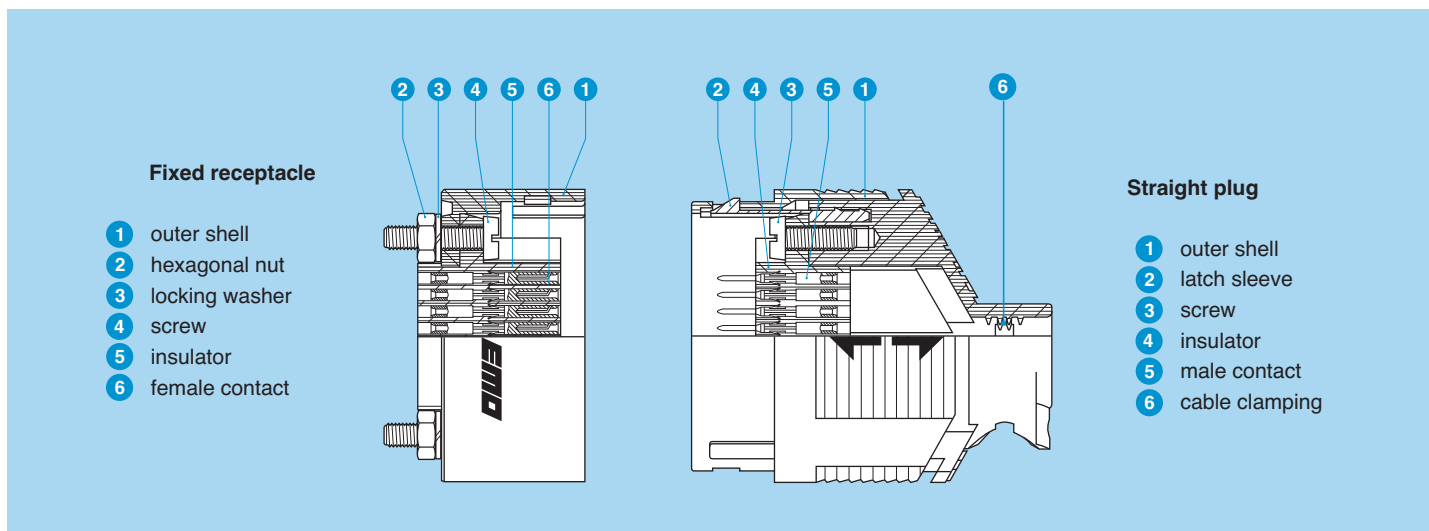





## Housing models

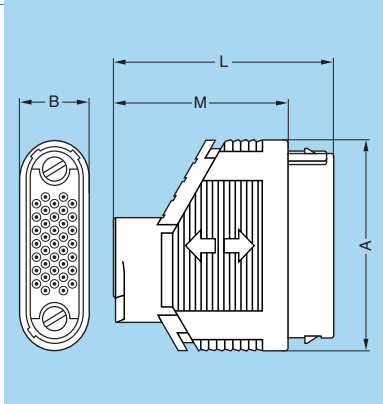

### FGG Straight plug, key (G) or key (A), with cable collet

Reference		Dimensions (mm)			
Model	Series	A	B	L	M
FGG	RR	18.0	6.0	21.5	17.0
FGG	0R	24.5	9.0	30.5	23.5
FGG	1R	37.0	12.5	39.0	31.0

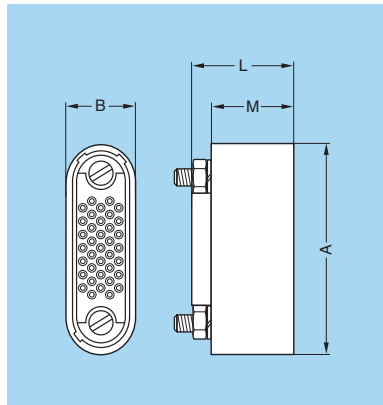

### EGG Fixed receptacle, key (G) or key (A) with visible shell

Reference		Dimensions (mm)			
Model	Series	A	B	L	M
EGG	RR	18.0	6.0	12.0	7.0
EGG	0R	24.5	9.0	14.0	12.0
EGG	1R	37.0	12.5	18.0	14.5

**P1** Panel cut-out page 26)

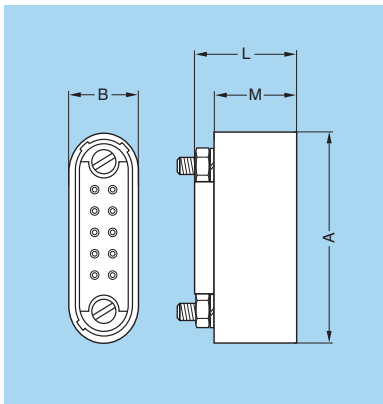
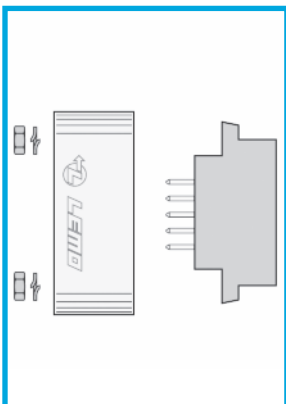

### EGG Fixed receptacle, key (G) or key (A) with visible shell and contacts for printed circuit

Reference		Dimensions (mm)			
Model	Series	A	B	L	M
EGG	RR	18.0	6.0	12.0	7.0
EGG	0R	24.5	9.0	14.0	12.0
EGG	1R	37.0	12.5	18.0	14.5

**P1** Panel cut-out page 26)

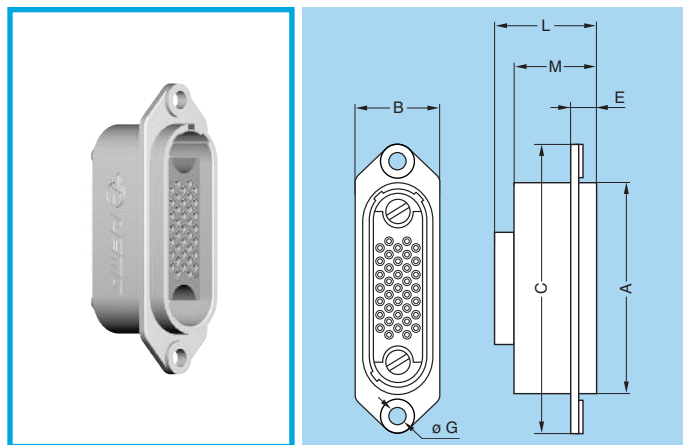

### EBG Fixed receptacle, key (G) or key (A), with flange

Reference		Dimensions (mm)						
Model	Series	A	B	C	E	G	L	M
EBG	1R	37.0	15.0	51.0	4.5	3.2	19.5	14.5
EBG	0R	24.5	10.5	34	3.2	2.2	18.0	12.0

**P2** Panel cut-out page 26

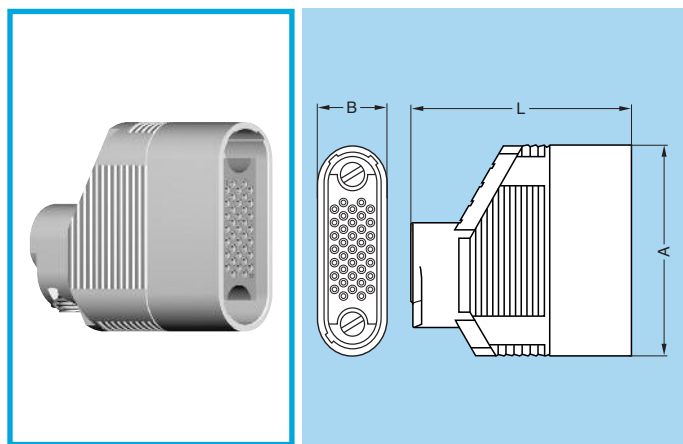

### PHG Free receptacle, key (G) or key (A), with cable collet

Reference		Dimensions (mm)		
Model	Series	A	B	L
PHG	RR	18.0	6.0	22.3
PHG	0R	24.5	9.0	31.5
PHG	1R	37.0	12.5	39.0

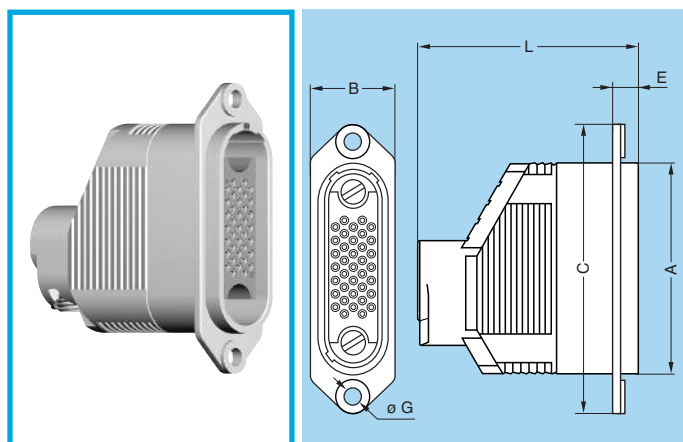

### PBG Fixed receptacle, key (G) or key (A), with flange and cable collet

Reference		Dimensions (mm)						
Model	Series	A	B	C	E	G	L	
PBG	1R	37.0	15.0	51.0	4.5	3.2	39.0	
PBG	0R	24.5	10.5	34.5	3.2	2.2	31.5	

**P2** Panel cut-out page 26

## Alignment Key

### Alignment Key and Polarized Keying System

R series connector model part numbers are composed of three letters. The LAST LETTER indicates the key position.

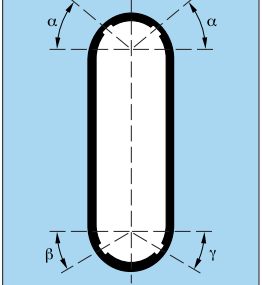
Front view of a receptacle 	Model	Nb of keys	Angles	Series			Contact type		Note
				RR	OR	1R	Plug	Receptacle	
				●●G	2	$\alpha$	50°	50°	
	1	$\beta$	30°	30°	30°	male	female	●	
●●A	2	$\alpha$	42°	42°	42°	male	female	○	
	1	$\gamma$	30°	30°	30°	male	female	○	

- First choice alternative
- Special order alternative

# Crimp Contacts

## Contacts for plugs, free or fixed receptacles

Ref.	Contact type	Ref.	Contact type
C	Male crimp (fig. 1) <sup>1)</sup>	P	Female crimp (fig. 2) <sup>1)</sup>
B	Male crimp (fig. 2) <sup>1)</sup>	U	Female crimp (fig. 2) <sup>1)</sup>
G	Male crimp (fig. 2) <sup>1)</sup>	N	Female straight print
M	Female crimp (fig. 1) <sup>1)</sup>		

**Note:** <sup>1)</sup> there are two forms of crimp barrels. Please consult adjacent table for contact selection

## Dimension of crimp barrels









Contact			Ref. contact type		Conductor			
ø A (mm)	ø C (mm)	Form per fig.	Male	Female	AWG		Section (mm <sup>2</sup> )	
					min.	max.	min.	max.
0.5	0.45	1	C	M	32	28	0.035	0.09
					26	22	0.140	0.34
0.7	0.80	1	C	M	32	28	0.035	0.09
	0.45	2	B	P	24	20	0.250	0.50
0.9	1.10	1	C	M	26	22	0.140	0.34
	0.80	2	B	P	32	28	0.035	0.09
	0.45	2	G	U				

## Contacts reference for plugs, free or fixed receptacles

Contact type	Reference		Contact			Conductor			
	Male	Female	ø A (mm)	ø C (mm)	Form per fig.	Stranded			
						AWG		Section (mm <sup>2</sup> )	
min.	max.	min.	max.						
<p style="text-align: center;">Crimp</p>	C	M	0.5	0.45	1	32	28	0.035	0.09
	C	M	0.7	0.80	1	26	22 <sup>1)</sup>	0.140	0.34
	B	P		0.45	2	32	28	0.035	0.09
	C	M	0.9	1.10	1	24	20	0.250	0.50
	B	P		0.80	2	26	22 <sup>1)</sup>	0.140	0.34
	G	U		0.45	2	32	28	0.035	0.09
<p style="text-align: center;">Print</p>	-	N	C dimensions are detailed in the section on PCB drilling pattern. See page 26.						

**Note:** <sup>1)</sup> for a given AWG, the diameter of some stranded conductor designs is larger than the crimp barrel diameter. Make sure that the maximum conductor diameter is smaller than ø C.

### Mixed / Hybrid Overview

Size	Ref	Number of LV Contacts	Diameter	Number of Hybrid Contact and Type	Insert
RR	804	4	0.5mm	1 coax, 50 ohm	
OR	004	4	0.7mm	4 pneumatic/fluidic 5 bars max pressure 3mm tube diameter	
OR	704	4	0.7mm	4 high voltage 2.7 kV rms (test volt) 7.5 kV dc (test volt)	
OR	804	4	0.7mm	4 coax, 50 ohms	
OR	813	13	0.7mm	2 coax, 50 ohm	
1R	003	8	0.9mm	8 pneumatic/fluidic 5 bars max pressure 3 mm tube diameter	
1R	703	3	0.9mm	8 high voltage 2.7 kV rms (test volt) 7.5 kV dc (test volt)	
1R	803	3	0.9mm	8 coax, 50 ohm	
1R	855	22 33	0.5mm 0.7mm	1 coax, 50 ohm	

Insert configuration

### Multipole

			Reference	Number of contacts	ø A (mm)	Contact type			Crimp contact Test voltage (kV rms) <sup>1)</sup> Contact-contact	Rated current (A) <sup>1)</sup>
	Male crimp contacts	Female crimp contacts				Crimp	Print (straight)	Print (elbow)		
<b>RR</b>			313	13	0.5	●	●	-	0.6	0.5
<b>OR</b>			310	10	0.9	●	●	-	1.5	3.5
			317	17	0.7	●	●	●	1.35	2.0
			337	37	0.5	●	●	-	0.6	0.5
<b>1R</b>			328	28	0.9	●	●	-	1.5	3.0
			336	36	0.7	●	●	-	1.5	2.5
			365	65	0.5	●	●	-	0.6	0.5
			367	67	0.5	●	●	-	0.6	0.5

www.lemo.com

13

## Mixed: High Voltage + Low Voltage

		Reference	High Voltage (HV)			Low Voltage (LV)				
Male HV contacts	Female HV contacts		Number of Contacts	Test voltage (kV dc) <sup>1)</sup>	Rated current (A)	Number of contacts	ø A (mm)	Crimp	Test voltage (kV rms) <sup>1)</sup> Contact-contact	Rated Current (A) <sup>1)</sup>
<b>OR</b>		704	4	7.5	2.0	4	0.7	●	1.35	2.0
		713	2	7.5	2.0	13	0.7	●	1.35	3.0
<b>1R</b>		703	8	7.5	2.0	3	0.9	●	1.5	3.5

Plug/Receptacle includes HV contacts.

### Male

**FGG.0R.403.ZLME15**

**HV contact  
Contact HT**



### Female

**EGG.0R.403.ZLCE15**

**HV contact  
Contact HT**



### Typical Assembly of High Voltage Contact

HV Contacts: Fit the HV sleeve onto the cable dielectric, check that all the HV conductor strands pass through the small hole.

Crimp the contact using tool DPC.91.701.V fitted with positioner DCE.91.051.BVCM, set to position 3. Fit by turning the HV sub-assembly on the HV sleeve and push until it butts. The two insulators should be at the same level.

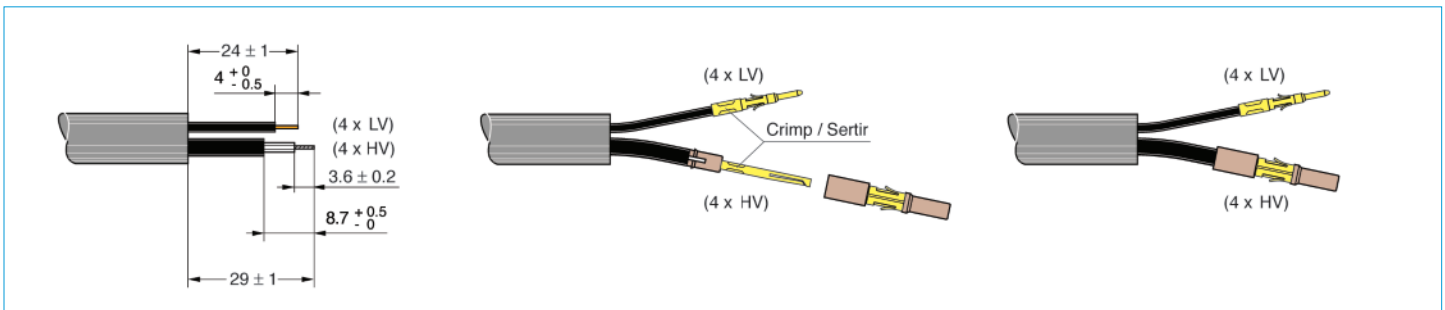

<b>HV Contact</b>	<b>Conductor Range</b>	<b>26-28 AWG</b>
<b>HV Contact</b>	<b>Maximum Dielectric</b>	<b>1.5mm</b>



## Mixed Coax + Low Voltage

	Male coax contacts	Female coax contacts	Reference	Coax				Low voltage (LV)				
				Number of contacts	Impedance ( $\Omega$ )	Type	Cable group	Number of contacts	$\phi$ A (mm)	Crimp contact	Test voltage (kV rms) <sup>1)</sup>	Rated current (A) <sup>1)</sup>
<b>RR</b>			804	1	0.5	RR	1	4	0.5	●	0.6	0.5
<b>OR</b>			804	4	50	OR	1	4	0.7	●	1.35	2
			813	2	50	OR	1	13	0.7	●	1.35	2
<b>1R</b>			803	8	50	1R	1	3	0.9	●	1.5	3
			855	1	50	1R	1	22 33	0.5 0.7	● ●	0.6 1.35	0.5 2.0

Plug/Receptacle includes Coax contacts.

### Male

**FGG.0R.250.ZLME28**

Coax contact  
Contact coax



### Female

**EGG.0R.250.ZLCE28**

Coax contact  
Contact coax



### Typical Assembly of Coax Contact (Coax Types - RG-174/U, RG-188 A/U, RG-316/U) = Cable Group 1

Coax contacts: Fit the crimp ferrule onto the cable. Crimp the contact using tool DPC.91.701.V fitted with postioner DCE.91.050.RVCM, set to position 3. Fit by turning the coax sub-assembly on the central contact until the stop is reached, check that the central contact is in the correct position in relation to the sub-assembly (0.5 mm), fold back the cable screen, place the crimp ferrule over the crimping area and complete the crimp using tool DPE.99.003.1K.

### Male

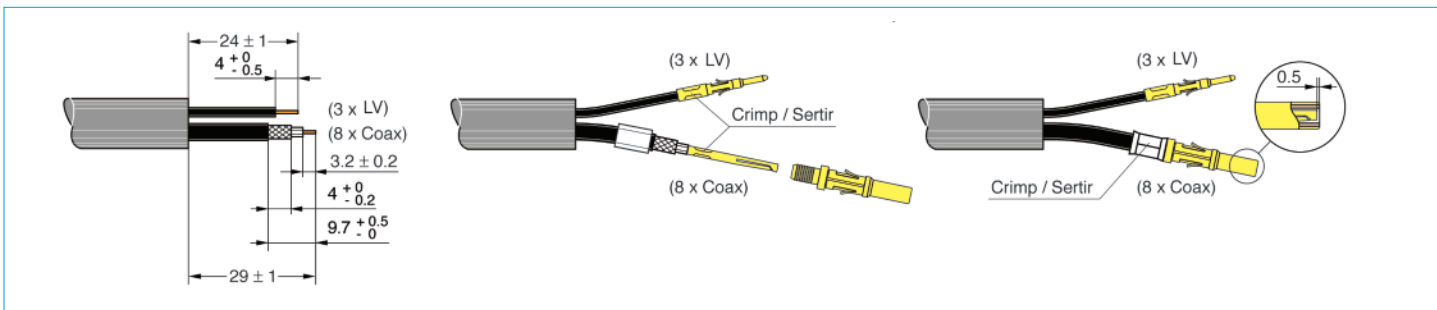

### Female

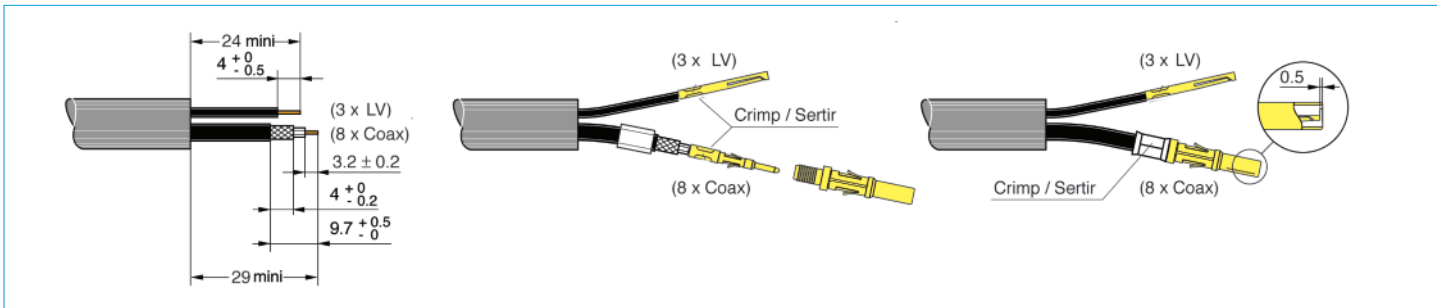

### Typical Performance

#### VSWR / T.O.S.

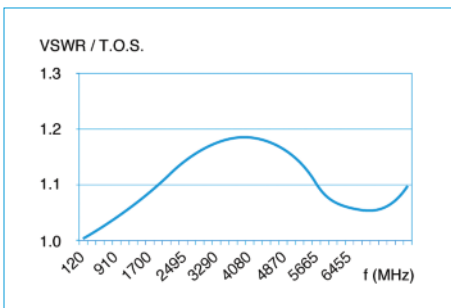

## Mixed: Fluidic + Low Voltage

		Reference	Fluidic			Low voltage (LV)				
Male fluidic contacts	Female fluidic contacts		Number of contacts	Flow (l/min)	Operating pressure (bars)	Number of contacts	ø A (mm)	Crimp contact	Test voltage (kV rms) <sup>1)</sup>	Rated current (A) <sup>1)</sup>
<b>0R</b>		004	4	8	5	4	0.7	●	1.35	2.0
		013	2	8	5	13	0.7	●	1.35	2.0
<b>1R</b>		003	8	8	5	3	0.9	●	1.5	3.0

Plug includes FGG.0R.010.AZA05 (w/ valve) contacts.  
 Receptacle includes EGG.0R.010.AZL05 (w/o valve) contacts.



## Fluidic / Pneumatic Contacts

### Fluidic / pneumatic male contact

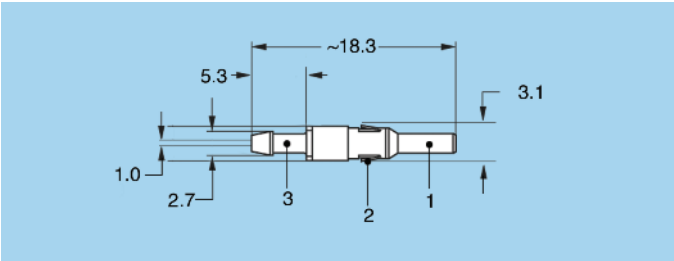

### FGG.0R.010.AZA05 Male fluidic / pneumatic contact

Part number
FGG.0R.010.AZA05 (2.7mm hose barb and valve)

**Note:** 3 – Hose fitting/ barb, 2 – retaining clips, 1 – male sleeve

### Fluidic / pneumatic male contact

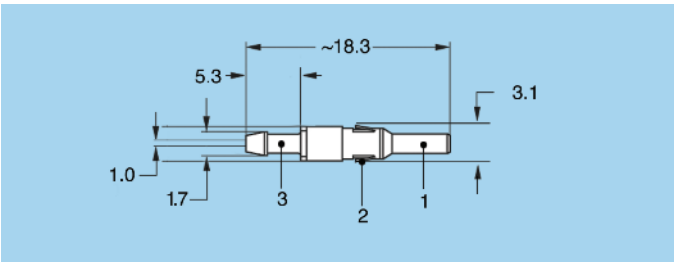
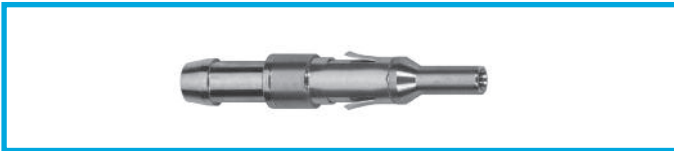

### FGG.0R.010.AZL05 Male fluidic / pneumatic contact

Part number
FGG.0R.010.AZL05 (1.7mm hose barb and non-valve)

**Note:** 3 – Hose fitting/ barb, 2 – retaining clips, 1 – male sleeve



## Fluidic / Pneumatic Contacts

### Fluidic / pneumatic female contact

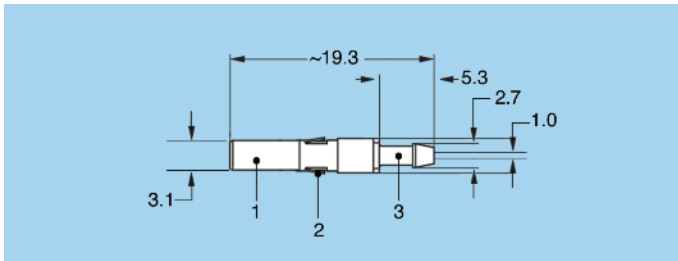

### EGG.0R.010.AZA05 Female fluidic / pneumatic contact

Part number
EGG.0R.010.AZA05 (2.7mm hose barb and valve)

**Note:** 1 – female sleeve, 2 – retaining clips, 3 – Hose fitting/ barb,

### Fluidic / pneumatic female contact

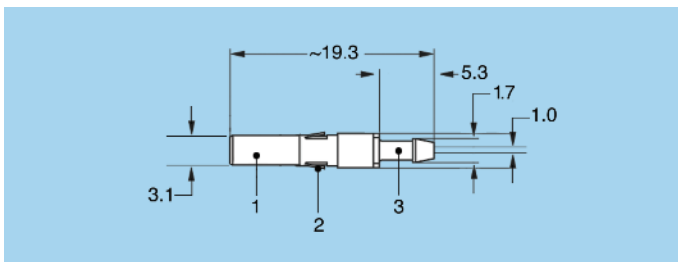
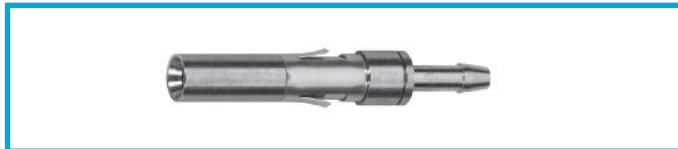

### EGG.0R.010.AZL05 Female fluidic /pneumatic contact

Part number
EGG.0R.010.AZL05 (1.7mm hose barb and non-valve)

**Note:** 1 – female sleeve, 2 – retaining clips, 3 – Hose fitting/ barb,



# Housings

Ref.	Color	RAL code
G	gray	7035
A	blue	6034
S	ochre	1028
V	green	6019

The exact color depends on manufacturing process and material pigments. For this reason some colors may differ from present RAL code.

**Note:** the connector shell material is Crastin® PBT.

## Accessories

### Collets



#### FGG Kit for cable clamping

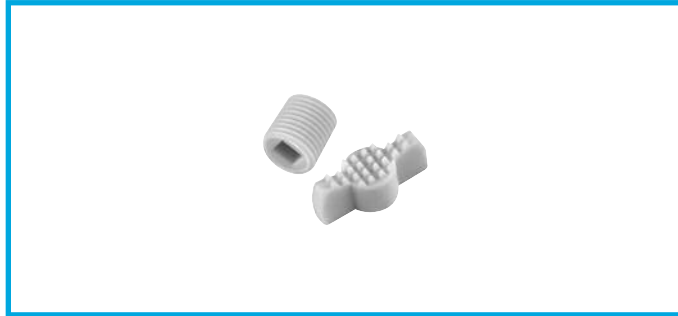

Part number	Series	Collet size	min.	max.
FGG.RR.740.IZG	RR	40	1.0	4.0
FGG.0R.762.IZG	0R	62	1.6	6.2
FGG.1R.792.IZG	1R	92	2.0	9.2

#### GEE Bracket

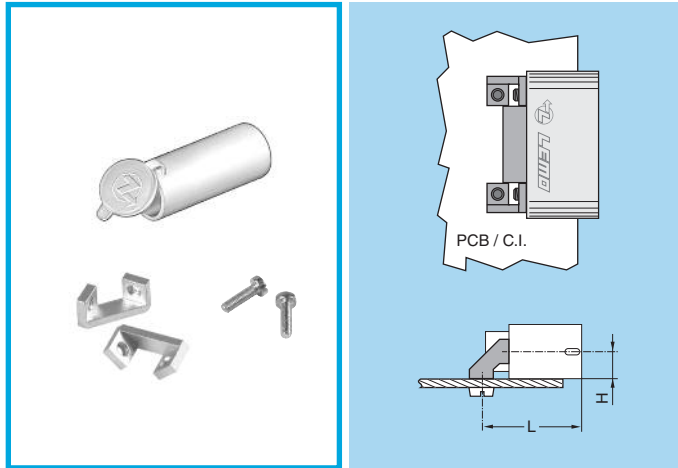

Part number	Series	Dimensions (mm)	
		L	H
GEE.RR.145.NZZ	RR	10.00	3.00
GEE.RR.146.NZZ		12.25	5.25
GEE.RR.147.NZZ		14.00	7.00
GEE.0R.145.NZZ	0R	16.50	4.50
GEE.0R.146.NZZ		18.25	6.25
GEE.0R.147.NZZ		22.50	10.50
GEE.1R.145.NZZ	1R	20.75	6.25
GEE.1R.146.NZZ		25.00	10.50
GEE.1R.147.NZZ		32.50	18.00

- Body material: Brass (UNS C 34500)
- Screws: Brass (UNS C 34500)

## Spare parts



### FGG-EGG Insulators for crimp contacts

	Type	Insulator part number	
		Male contact	Female contact
<b>RR</b>	313	FGG.RR.313.YL	EGG.RR.413.YL
<b>OR</b>	310	FGG.OR.310.YL	EGG.OR.410.YL
	317	FGG.OR.317.YL	EGG.OR.417.YL
	337	FGG.OR.337.YL	EGG.OR.437.YL
<b>1R</b>	328	FGG.1R.328.YL	EGG.1R.428.YL
	336	FGG.1R.336.YL	EGG.1R.436.YL
	365	FGG.1R.365.YL	EGG.1R.465.YL
	367	FGG.1R.367.YL	EGG.1R.467.YL

### FGG-EGG Crimp contacts

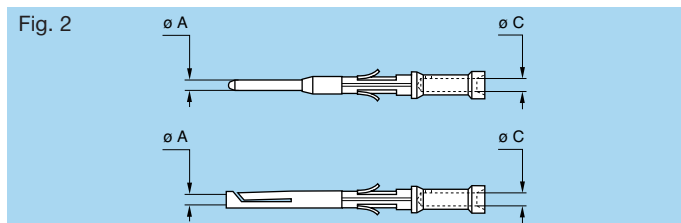
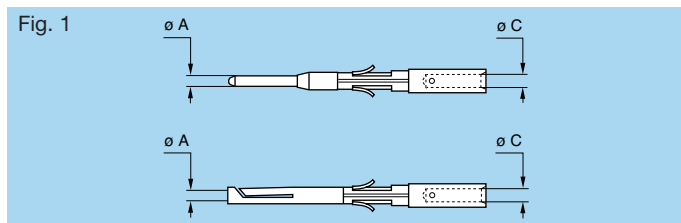

	Types	ø (mm)		Contact part number	
		ø A (mm)	ø C (mm)	Male	Female
<b>RR</b>	313	0.5	0.45	FGG.00.554.ZZC	EGG.00.654.ZZM
<b>OR</b>	310	0.9	1.10	FGG.0B.560.ZZC	EGG.0B.660.ZZM
	317	0.7	0.80	FGG.0B.555.ZZC	EGG.0B.655.ZZM
	337	0.5	0.45	FGG.00.554.ZZC	EGG.00.654.ZZM
<b>1R</b>	328	0.9	1.10	FGG.0B.560.ZZC	EGG.0B.660.ZZM
	336	0.7	0.80	FGG.0B.555.ZZC	EGG.0B.655.ZZM
	365/367	0.5	0.45	FGG.0B.554.ZZC	EGG.1B.654.ZZM

	Types	ø (mm)		Contact part number	
		ø A (mm)	ø C (mm)	Male	Female
<b>OR</b>	310	0.9	0.80	FGG.0B.561.ZZC	EGG.0B.661.ZZM
	310	0.9	0.45	FGG.0B.562.ZZC	EGG.0B.662.ZZM
	317	0.7	0.45	FGG.0B.556.ZZC	EGG.0B.656.ZZM
<b>1R</b>	328	0.9	0.80	FGG.0B.561.ZZC	EGG.0B.661.ZZM
	328	0.9	0.45	FGG.0B.562.ZZC	EGG.0B.662.ZZM
	336	0.7	0.45	FGG.0B.556.ZZC	EGG.0B.656.ZZM



## Tooling

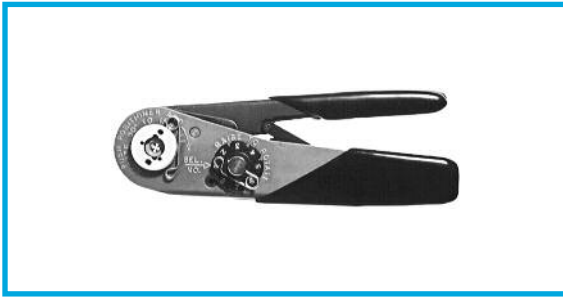

### Manual crimping tools

Supplier	Part number
	contact $\varnothing$ 0.5-0.7-0.9
LEMO	DPC.91.701.V <sup>1)</sup>
DANIELS	MH860 <sup>1)</sup>
ASTRO	616336 <sup>1)</sup>

<sup>1)</sup> According to specification MIL-C-22520/7-01.



### DPE Manual crimping tool w/ die for coax contacts

Part number	Cable group
DPE.99.003.1K	1

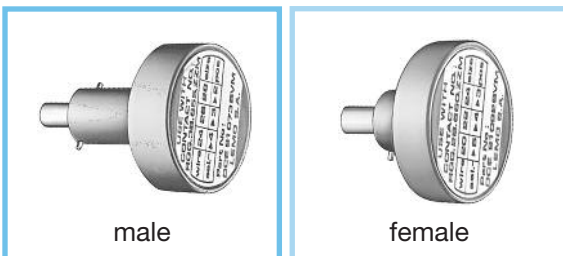

### DCE Positioners for crimp contacts $\varnothing$ 0.5-0.7 and 0.9 mm

These positioners are suitable for use with both manual and pneumatic crimping tools according to the MIL-C-22520/7-01 standard.

	Connector + Contact					Positioners part number	
	Type	$\varnothing$ A	$\varnothing$ C	$\frac{L}{\varnothing}$	Conductor AWG	For male contact	For female contact
<b>RR</b>	313	0.5	0.45	1	28-30-32	DCE.91.050.0VC	DCE.91.050.0VM
<b>OR</b>	310	0.9	1.10	1	20-22-24	DCE.91.090.BVC	DCE.91.090.BVM
		0.9	0.80	2	22-24-26	DCE.91.090.AVC	DCE.91.090.AVM
		0.9	0.45	2	28-30-32	DCE.91.070.BVC	DCE.91.070.BVM
		0.7	0.80	1	22-24-26	DCE.91.070.AVC	DCE.91.070.AVM
<b>1R</b>	317	0.7	0.80	1	22-24-26	DCE.91.070.BVC	DCE.91.070.BVM
		0.7	0.45	2	28-30-32	DCE.91.050.0VC	DCE.91.050.0VM
<b>1R</b>	328	0.9	1.10	1	20-22-24	DCE.91.090.BVC	DCE.91.090.BVM
		0.9	0.80	2	22-24-26	DCE.91.090.AVC	DCE.91.090.AVM
		0.9	0.45	2	28-30-32	DCE.91.070.BVC	DCE.91.070.BVM
	336	0.7	0.80	1	22-24-26	DCE.91.070.BVC	DCE.91.070.BVM
		0.7	0.45	2	28-30-32	DCE.91.050.0VC	DCE.91.051.BVM
	365/367	0.5	0.45	1	28-30-32	DCE.91.050.0VC	DCE.91.051.BVM

**Note:** a wide variation of strand number and diameter combinations are quoted as being AWG, some of which do not have a large enough cross section to guarantee a crimp as per either MIL-C-22520/1-01 or /7-01. Our technical department is at your disposal to study and propose a solution to all your applications.

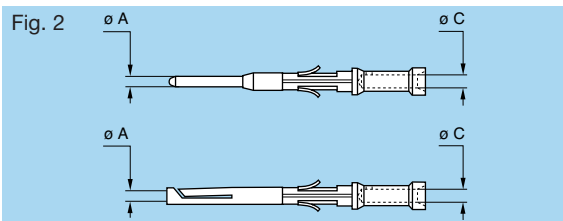
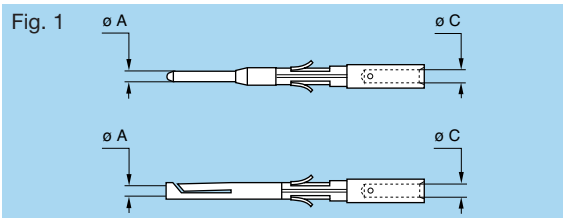

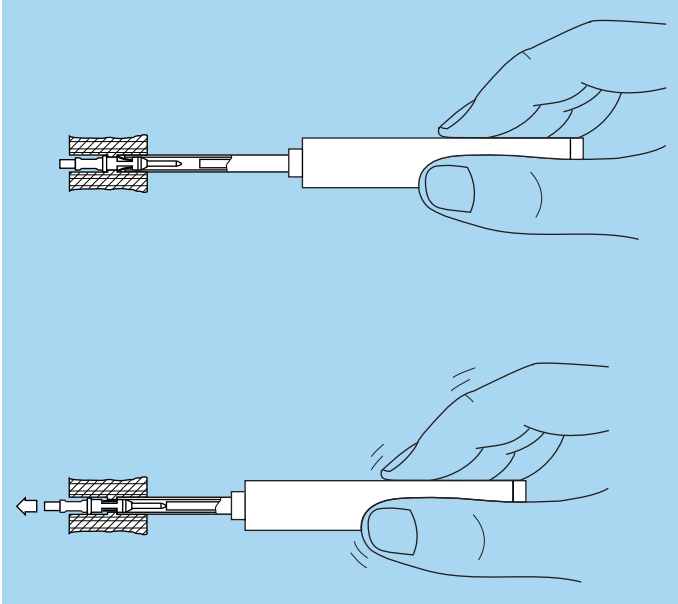
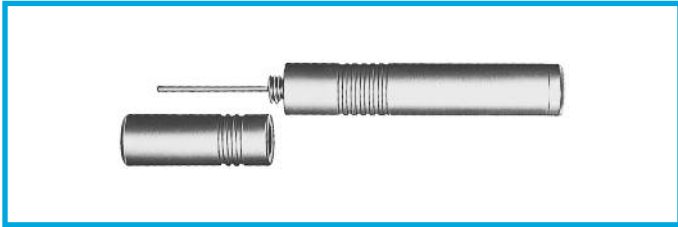

### DCF Extraction tools for crimp contacts

	Connector		Extractors
	Type	Contact ø A	Part number
<b>RR</b>	313	0.5	DCF.91.050.2LT
	310	0.9	DCF.91.090.2LT
	317	0.7	DCF.91.070.2LT
<b>OR</b>	337	0.5	DCF.91.050.2LT
	328	0.9	DCF.91.090.2LT
	336	0.7	DCF.91.070.2LT
<b>1R</b>	365/367	0.5	DCF.91.050.2LT

**Note:** this model is used for male and female contacts.

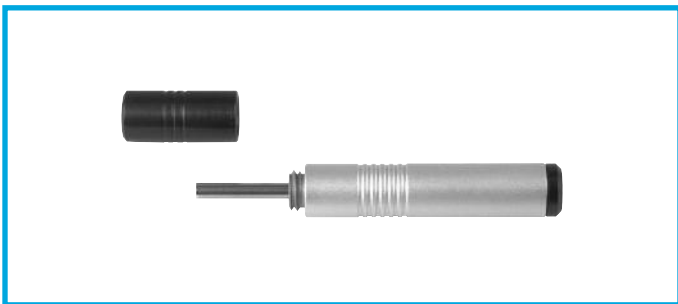

### DCF Extraction tools for coax or HV contacts

Part number	Series
DCF.91.215.1LT	RR
DCF.91.270.1LT	OR
DCF.91.270.1LT	1R



### DCT Cable clamping tool

Part number	Series
DCT.91.165.PR	RR
DCT.91.205.PR	OR
DCT.91.205.PR	1R

- Material: translucent plastic and steel

# Panel cut-outs

P1 - EGG

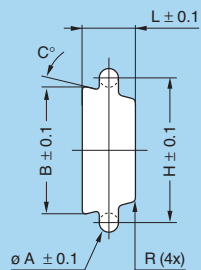

P2 - EBG, PBG

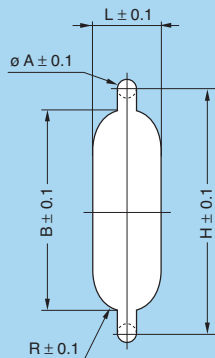

R series

Series	P1					P2					
	ø A	B	C	H	L	R	ø A	B	H	L	R
RR	1.7	7.8	5	11	3.5	-	-	-	-	-	-
OR	2.2	14.2	7	17	5.7	1.0	2.2	24.6	30	9.2	4.7
1R	3.2	22.2	10	25	8.5	1.2	3.2	37.4	45.0	12.8	6.4

## PCB drilling pattern

### Fixed receptacle with straight print contact (EGG models)

RR.313

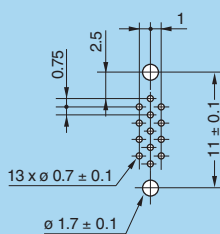

OR.310

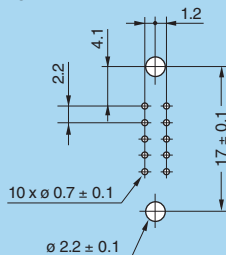

OR.317

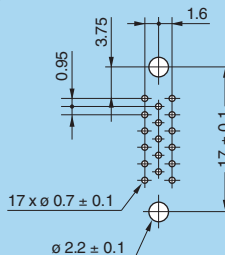

OR.337

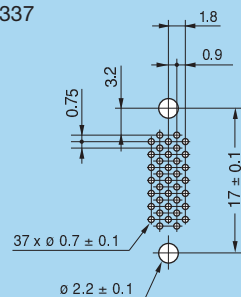

1R.328

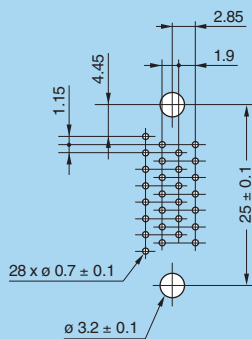

1R.336

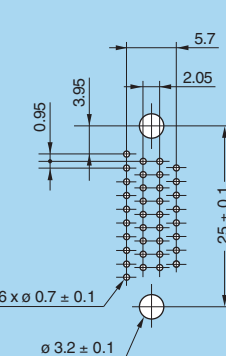

1R.365

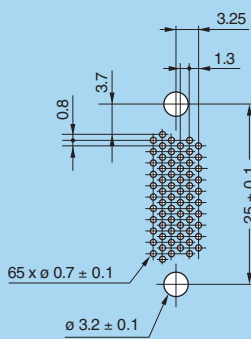

1R.367

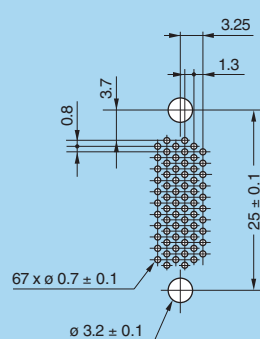

### Fixed receptacle with straight print contact (EBG models)

1R.328

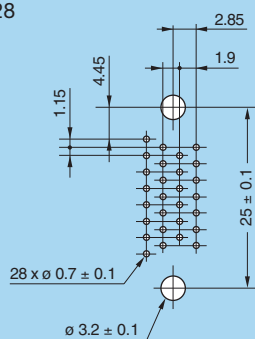

1R.336

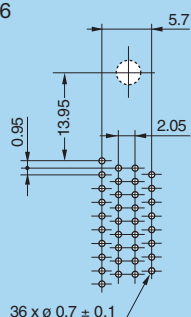

1R.365

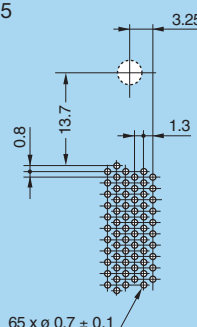

1R.855

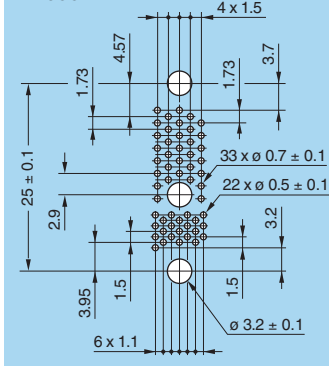

## Technical characteristics

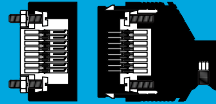

### Outer shell

The R series is made of lightweight polyester resin Crastin® PBT from Dupont™ with metal latches.

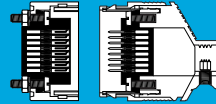

### Insulator

The insulators are made of PEEK plastic. The insulators of the coax contact and the high voltage contact are Teflon™.

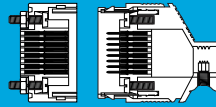

## Electrical contact

### Technical description

The secure reliable electromechanical connection achieved with LEMO female cylindrical contacts is mainly due to two important design features:

1. *Prod proof entry* on the mating side which ensures perfect concentric mating even with carelessly handled connectors.
2. *The pressure spring*, with good elasticity, maintains a constant even force on the male contact when mated. The leading edge of the pressure spring preserves the surface treatment (gold-plated) and prevents undue wear.

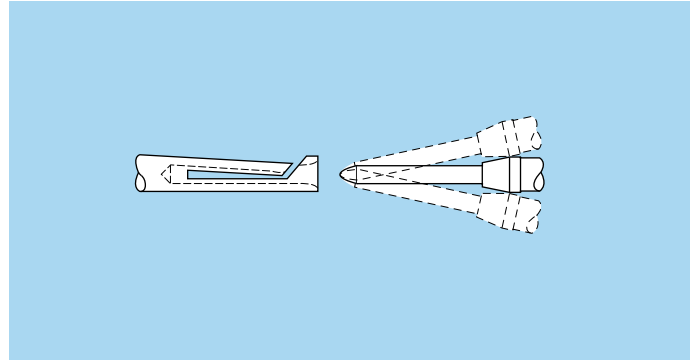

### Contact material and treatment

LEMO female contacts are made of bronze beryllium (QQ-C-530) or bronze (UNS C 54400). These materials are chosen because of their high modulus of elasticity, their excellent electrical conductivity and a high mechanical strength.

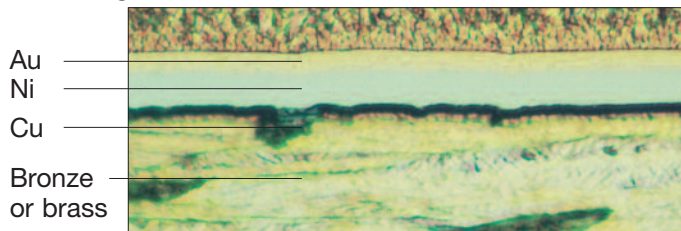

LEMO male solder and print contacts are made of brass (UNS C 38500). Male crimp contacts are made of brass (UNS C 34500) or annealed brass (UNS C 38500) with optimum hardness (HV) for crimping onto the wire.

Type	Material (standard)	Surf. treatment (µm)		
		Cu	Ni	Au <sup>1)</sup>
Male crimp	Brass (UNS C 34500)	0.5	3	1.0
	Brass (UNS C 38500)			
Male print	Brass (UNS C 38500)			
Female crimp	Bronze (UNS C 54400)	0.5	3	1.5
Female print	Cu-Be (FS QQ-C-530)			
Clips	Cu-Be (FS QQ-C-530)	-	-	-
	Stainless steel			
Wire <sup>2)</sup>	Brass	-	3 <sup>3)</sup>	-

**Notes:** the standard surface treatment are as follows:

- nickel: FS QQ-N-290A or MIL-C-26074C

- gold: ISO 4523.

<sup>1)</sup> minimum value

<sup>2)</sup> for elbow print contacts

<sup>3)</sup> treatment completed by 6 µm Sn-Pb tin-plating

### Crimp contacts

The square form crimp method is used (MIL-C-22520F, class I, type 2) photo 1 for unipole contacts.

For multipole contacts the standard four identifier crimp method is used, MIL-C-22520F, class I, type 1), photo 2. The crimp method requires a controlled compression to obtain a symmetrical deformation of the conductor strand and of the contact material. The radial hole in the side of the contact makes it possible to check whether the conductor is correctly positioned within the contact. A good crimping is characterized by only slightly reduced conductor section and practically no gap.

For optimum crimping of bronze or brass contacts they are annealed to relieve internal stress and reduce material hardening during the crimping process. Only the crimping zone is annealed with the help of an induction heating machine designed by the LEMO Research and Development Department (see photo 3).

### Advantages of crimping

- practical, quick contact fixing outside the insulator
- possible use at high temperature
- no risk of heating the insulator during the conductor-contact fixing
- high tensile strength

Crimp contacts are available in standard version (form 1) for mounting maximum size conductors. For some dimensions, these crimp contacts can be produced with reduced crimp barrels (form 2) for mounting reduced size conductors.

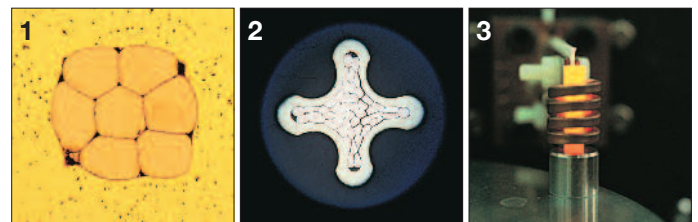

### Crimp contacts

The crimp contacts can be with two forms: a standard crimp barrel for large conductors (see fig. 1) or with a reduced crimp barrel for smaller conductors (see fig. 2).

The range of cable dimensions that can be crimped into our contacts are indicated on the table on page 9.

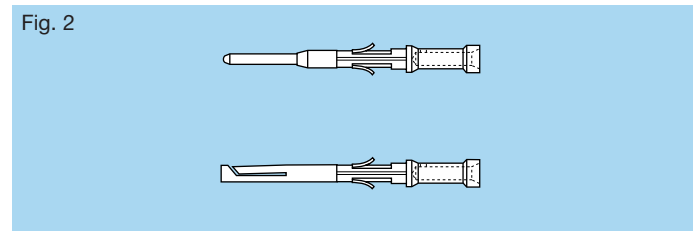
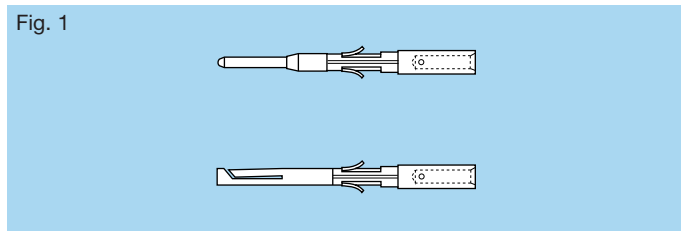

## LEMO HEADQUARTERS

### SWITZERLAND

#### LEMO SA

Chemin des Champs-Courbes 28 - P.O. Box 194 - CH-1024 Ecublens  
Tel. (+41 21) 695 16 00 - Fax (+41 21) 695 16 02 - e-mail: info@lemo.com

## LEMO SUBSIDIARIES

### AUSTRIA

#### LEMO Elektronik GesmbH

Lemböckgasse 49/E6-3  
1230 Wien  
Tel: (+43 1) 914 23 20 0  
Fax: (+43 1) 914 23 20 11  
sales@lemo.at

### BRAZIL

#### LEMO Latin America Ltda

Av. Jose Rocha Bonfirm,  
214 Salas 224 / 225  
Condominio Praca Capital  
Ed Chicago  
Campinas / SP - Brasil -13080-650  
Tel: +55 (11) 98689 4736  
info-la@lemo.com

### CANADA

#### LEMO Canada Inc

44 East Beaver Creek Road, Unit 20  
Richmond Hill, Ontario L4B 1G8  
Tel: (+1 905) 889 5678  
info-canada@lemo.com

### CHINA / HONG KONG

#### LEMO Electronics (Shanghai) Co., Ltd

First Floor, Block E  
18 Jindian Road, Pudong  
Shanghai, China 201206  
Tel: (+86 21) 5899 7721  
Fax: (+86 21) 5899 7727  
cn.sales@lemo.com

### DENMARK

#### LEMO Denmark A/S

Gammel Mosevej 46  
2820 Gentofte  
Tel: (+45) 45 20 44 00  
Fax: (+45) 45 20 44 01  
info-dk@lemo.com

### FRANCE

#### LEMO France Sàrl

24/28 Avenue Graham Bell  
Bâtiment Balthus 4  
Bussy Saint Georges  
77607 Marne la Vallée Cedex 3  
Tel: (+33 1) 60 94 60 94  
Fax: (+33 1) 60 94 60 90  
info-fr@lemo.com

### GERMANY

#### LEMO Elektronik GmbH

Hanns-Schwindt-Str. 6  
81829 München  
Tel: (+49 89) 42 77 03  
Fax: (+49 89) 420 21 92  
info@lemo.de

### HUNGARY

#### REDEL Elektronika Kft

Nagysándor József u. 6-12  
H-1201 Budapest  
Tel: (+36 1) 421 47 10  
Fax: (+36 1) 421 47 57  
info-hu@lemo.com

### ITALY

#### LEMO Italia srl

Viale Lunigiana 25  
20125 Milano  
Tel: (+39 02) 66 71 10 46  
Fax: (+39 02) 66 71 10 66  
sales.it@lemo.com

### JAPAN

#### LEMO Japan Ltd

2-7-22, Mita,  
Minato-ku, Tokyo, 108-0073  
Tel: (+81 3) 54 46 55 10  
Fax: (+81 3) 54 46 55 11  
lemoinfo@lemo.co.jp

### NETHERLANDS / BELGIUM

#### LEMO Connectors Benelux

De Trompet 1060  
1967 DD Heemskerk  
Tel. (+31) 251 25 78 20  
Fax (+31) 251 25 78 21  
info@lemo.nl

### NORWAY / ICELAND

#### LEMO Norway A/S

Stanseveien 6B  
0975 Oslo  
Tel: (+47) 22 91 70 40  
Fax: (+47) 22 91 70 41  
info-no@lemo.com

### SINGAPORE

#### LEMO Asia Pte Ltd

4 Leng Kee Road,  
#06-09 SiS Building  
Singapore 159088  
Tel: (+65) 6476 0672  
Fax: (+65) 6474 0672  
sg.sales@lemo.com

### SPAIN / PORTUGAL

#### IBERLEMO SAU

Brasil, 45, 08402 Granollers  
Barcelona  
Tel: (+34 93) 860 44 20  
Fax: (+34 93) 879 10 77  
info-es@lemo.com

### SWEDEN / FINLAND

#### LEMO Nordic AB

Mariehällsvägen 39A  
168 65 Bromma  
Tel: (+46 8) 635 60 60  
Fax: (+46 8) 635 60 61  
info-se@lemo.com

### SWITZERLAND

#### LEMO Verkauf AG

Grundstrasse 22 B  
6343 Rotkreuz  
Tel: (+41 41) 790 49 40  
Fax: (+41 41) 790 49 43  
ch.sales@lemo.com

### UNITED KINGDOM

#### LEMO UK Ltd

12-20 North Street  
Worthing, West Sussex, BN11 1DU  
Tel: (+44 1903) 23 45 43  
Fax: (+44 1903) 20 62 31  
lemouk@lemo.com

## LEMO DISTRIBUTORS

AUSTRALIA, BRAZIL, CZECH REPUBLIC,  
GREECE, INDIA, ISRAEL, NEW ZEALAND,  
PAKISTAN, POLAND, RUSSIA, SOUTH  
AFRICA, SOUTH KOREA, TAIWAN, TURKEY,  
UKRAINE

## LEMO USA Inc

P.O. Box 2408 • Rohnert Park, CA 94927-2408  
Tel: (+1 707) 578 8811 • (+1 800) 444 5366 • Fax: (+1 707) 578 0869  
info-us@lemo.com

[www.lemo.com](http://www.lemo.com)