

RPR-220

Reflective photosensor (photoreflexor)

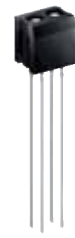

Absolute maximum ratings (Ta=25°C)

Parameter	Symbol	Limits	Unit	
Input (LED)	Forward current	I _F	50	mA
	Reverse voltage	V _R	5	V
	Power dissipation	P _D	80	mW
Output (photo-transistor)	Collector-emitter voltage	V _{CEO}	30	V
	Emitter-collector voltage	V _{ECO}	4.5	V
	Collector current	I _C	30	mA
	Collector power dissipation	P _C	80	mW
Operating temperature	T _{opr}	-25 to +85	°C	
Storage temperature	T _{stg}	-30 to +85	°C	

Applications

- Compact disc players
- Copiers
- Game machines
- Office automation equipment

Features

- 1) A plastic lens is used for high sensitivity.
- 2) A built-in visible light filter minimizes the influence of stray light.
- 3) Lightweight and compact.

Electrical and optical characteristics (Ta=25°C)

Parameter	Symbol	Min.	Typ.	Max.	Unit	Conditions	
Input characteristics	Forward voltage	V _F	1.34	1.6	V	I _F =50mA	
	Reverse current	I _R	-	10	μA	V _R =5V	
Output characteristics	Dark current	I _{CEO}	-	0.5	μA	V _{CE} =10V	
	Peak sensitivity wavelength	λ _P	800	-	nm	-	
Transfer characteristics	Collector current	I _C	0.08	0.3	0.8	mA	V _{CE} =2V, I _F =10mA
	Collector-emitter saturation voltage	V _{CE(sat)}	-	0.1	0.3	V	I _F =20mA, I _C =0.1mA
	Response time	t _r ·t _f	-	10	-	μs	V _{CE} =5V, I _F =20mA, R _L =100Ω
Infrared light emitting diode	Cut-off frequency	f _c	1	-	MHz	I _F =50mA * Non-coherent Infrared light emitting diode used.	
	Peak light emitting wavelength	λ _P	940	-	nm	-	
Photo transistor	Response time	t _r ·t _f	10	-	μs	V _{CC} =5V, I _C =1mA, R _L =100Ω * This product is not designed to be protected against electromagnetic wave.	
	Maximum sensitivity wavelength	λ _P	800	-	nm	-	

* Reflector object : Standard white paper. (Reflection ratio = 90%)

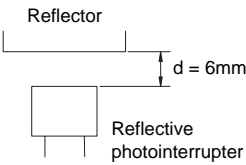

Electrical and optical characteristics curves

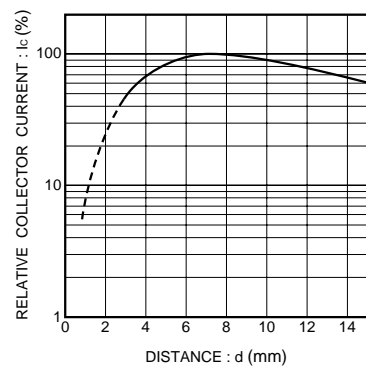

Fig.1 Relative output vs. distance

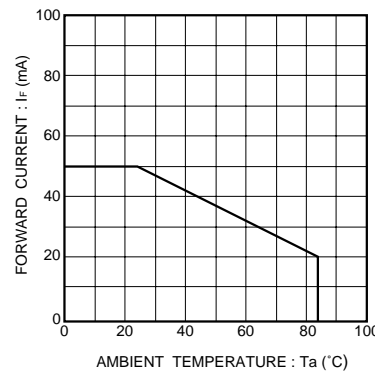

Fig.2 Forward current vs. ambient temperature

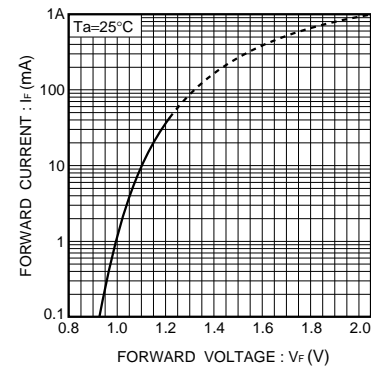

Fig.3 Forward current vs. forward voltage

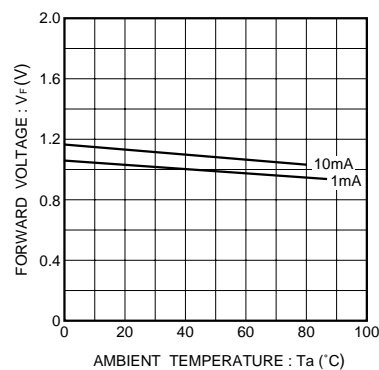

Fig.4 Forward voltage vs. ambient temperature

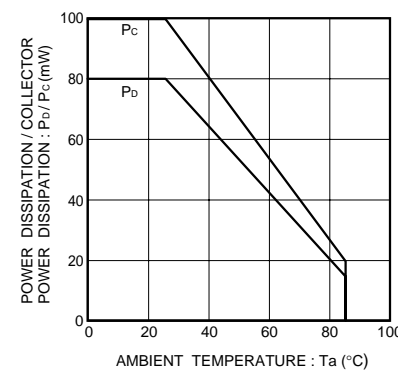

Fig.5 Power dissipation / collector power dissipation vs. ambient temperature

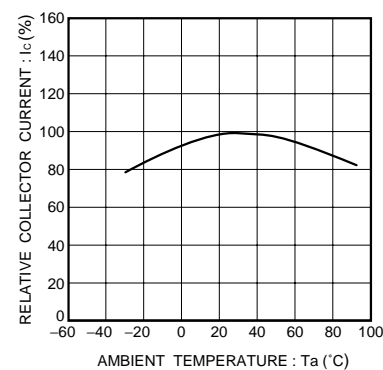
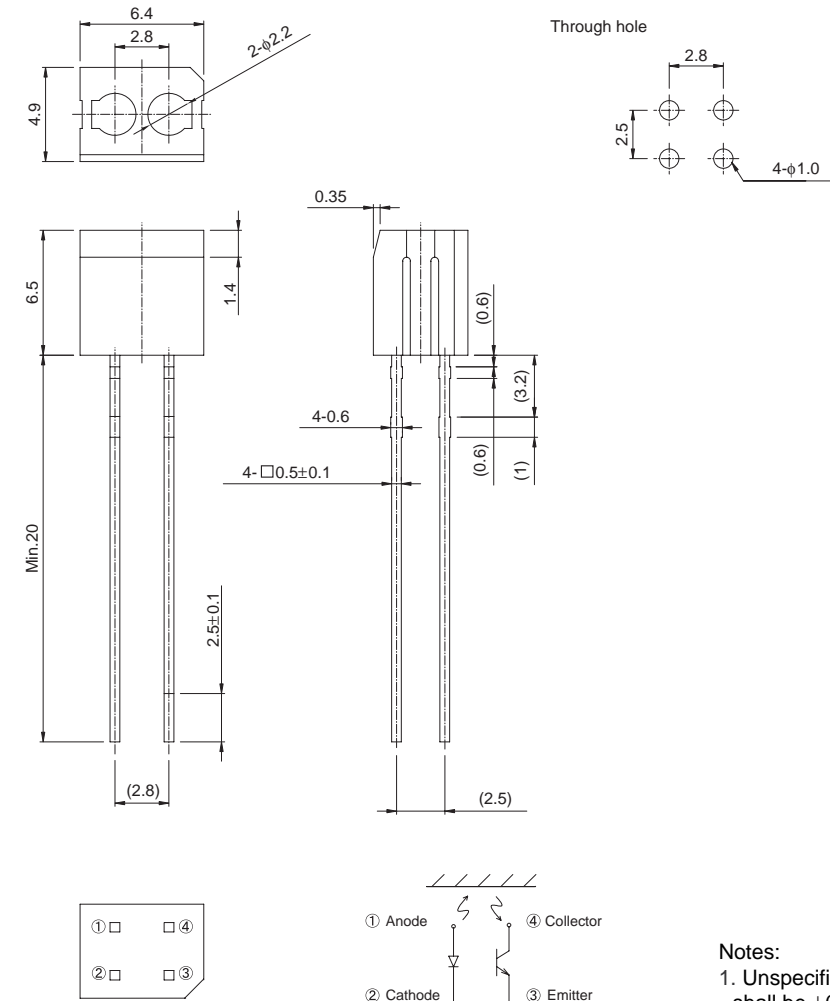

Fig.6 Relative output vs. ambient temperature

External dimensions (Unit : mm)



Notes:

1. Unspecified tolerance shall be ±0.2.
2. Dimension in parenthesis show for reference.

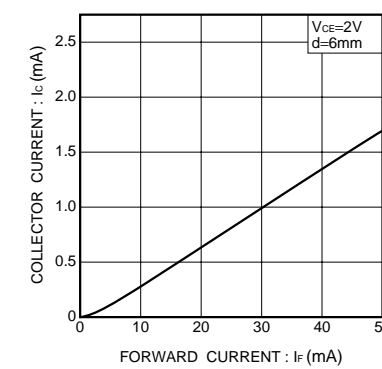

Fig.7 Collector current vs. forward current

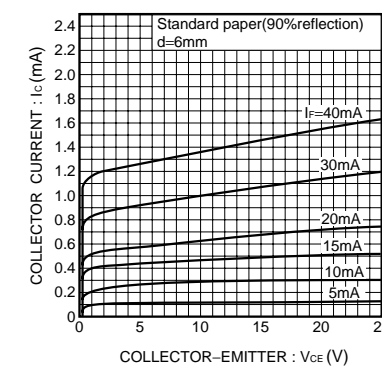

Fig.8 Output characteristics

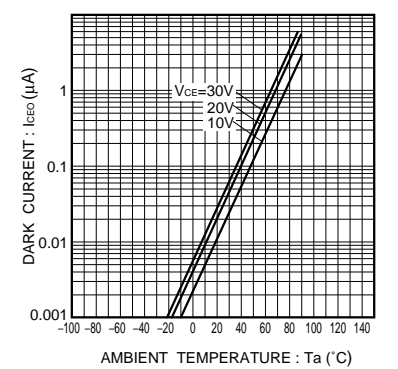

Fig.9 Dark current vs. ambient temperature

Notes

- No technical content pages of this document may be reproduced in any form or transmitted by any means without prior permission of ROHM CO.,LTD.
- The contents described herein are subject to change without notice. The specifications for the product described in this document are for reference only. Upon actual use, therefore, please request that specifications to be separately delivered.
- Application circuit diagrams and circuit constants contained herein are shown as examples of standard use and operation. Please pay careful attention to the peripheral conditions when designing circuits and deciding upon circuit constants in the set.
- Any data, including, but not limited to application circuit diagrams information, described herein are intended only as illustrations of such devices and not as the specifications for such devices. ROHM CO.,LTD. disclaims any warranty that any use of such devices shall be free from infringement of any third party's intellectual property rights or other proprietary rights, and further, assumes no liability of whatsoever nature in the event of any such infringement, or arising from or connected with or related to the use of such devices.
- Upon the sale of any such devices, other than for buyer's right to use such devices itself, resell or otherwise dispose of the same, no express or implied right or license to practice or commercially exploit any intellectual property rights or other proprietary rights owned or controlled by
- ROHM CO., LTD. is granted to any such buyer.
- Products listed in this document are no antiradiation design.

The products listed in this document are designed to be used with ordinary electronic equipment or devices (such as audio visual equipment, office-automation equipment, communications devices, electrical appliances and electronic toys).

Should you intend to use these products with equipment or devices which require an extremely high level of reliability and the malfunction of which would directly endanger human life (such as medical instruments, transportation equipment, aerospace machinery, nuclear-reactor controllers, fuel controllers and other safety devices), please be sure to consult with our sales representative in advance.

About Export Control Order in Japan

Products described herein are the objects of controlled goods in Annex 1 (Item 16) of Export Trade Control Order in Japan.

In case of export from Japan, please confirm if it applies to "objective" criteria or an "informed" (by MITI clause) on the basis of "catch all controls for Non-Proliferation of Weapons of Mass Destruction.