

**5V/3.3V 2.5Gbps VARIABLE  
OUTPUT SWING PECL/ECL  
DIFFERENTIAL RECEIVER****Precision Edge®  
SY89307V****FEATURES**

- 3.3V and 5V power supply options
- >2.5Gbps maximum throughput
- Fast output transitions <160ps  $t_r / t_f$
- 100k compatible PECL/ECL I/O
- Functionally equivalent to SY88927V and SY100EP16VS
- Variable output swing from 100mV to 700mV
- Guaranteed operation over  $-40^{\circ}\text{C}$  to  $+85^{\circ}\text{C}$  temperature range
- Available in ultra-small 8-pin MLF® (2mm x 2mm) package

**APPLICATIONS**

- Multimode optical transceiver
- VCSEL driver
- Backplane receiver

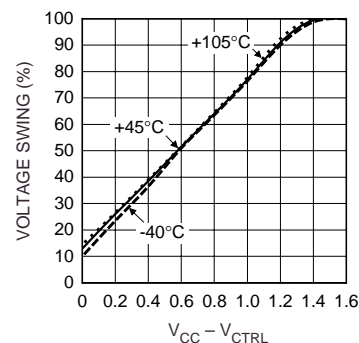
**Precision Edge®****DESCRIPTION**

The SY89307V is a differential receiver with a variable output swing. It is functionally equivalent to the SY100EP16VS but in an ultra-small 8-lead MLF® package that features a 70% smaller footprint. Like the EP16VS its variable output swing makes it ideal for use as a VCSEL laser driver.

The operational range of the SY89307V control input is from  $V_{BB}$  (maximum output swing) to  $V_{CC}$  (minimum output swing). The output swing can be controlled by a variable resistor between the  $V_{BB}$  pin and  $V_{CC}$  with the wiper driving  $V_{CTRL}$ .

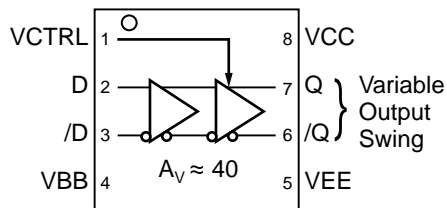
The SY89307V provides a  $V_{BB}$  output for either single-ended use or as a DC bias for AC-coupling to the device. The  $V_{BB}$  pin should be used only as a bias for this device as its current sink/source capability is limited. Whenever used, the  $V_{BB}$  pin should be bypassed to  $V_{CC}$  via a 0.01 $\mu\text{F}$  capacitor.

Under open input conditions the Q output will be LOW.

**TYPICAL VOLTAGE OUTPUT SWING**

**Typical Voltage Output Swing**  
 $V_{CC} = 3.3\text{V or }5\text{V}$

**PACKAGE/ORDERING INFORMATION**



**TOP VIEW**  
**8-Pin MLF®**  
**Ultra-Small Outline**  
**(2mm x 2mm)**

**Ordering Information**

Part Number	Package Type	Operating Range	Package Marking	Lead Finish
SY89307VMITR	MLF-8	Industrial	P16S	Sn-Pb
SY89307VMGTR <sup>(1)</sup>	MLF-8	Industrial	P16S with Pb-Free bar-line indicator	Pb-Free NiPdAu

**Note:**

1. Pb-Free package is recommended for new designs.

**PIN DESCRIPTION**

Pin Number	Pin Name	Type	Pin Function
2, 3	D, /D	100K ECL Input	Differential PECL/ECL Inputs: If inputs are left open, Q output will default to LOW. See "Input Interface Applications" section for single-ended inputs.
7, 6	Q, /Q	100K PECL/ECL Output	Differential Outputs: Variable swing PECL/ECL output pair defaults to LOW if D inputs left open. See "Application Implementation" section for recommendations on terminations.
8	VCC	Positive Power Supply	Positive Power Supply: Bypass with 0.1µF//0.01µF low ESR capacitors.
5	VEE, Exposed Pad	Negative Power Supply	Negative Power Supply: V <sub>EE</sub> and Exposed pad must be tied to most negative supply. For PECL/LVPECL connect to ground.
4	VBB	Reference Voltage Output	Bias Voltage: V <sub>CC</sub> -1.3V. Used as reference voltage when AC-coupling to the D, /D inputs. Bypass with 0.01µF capacitor to V <sub>CC</sub> .
1	VCTRL	Control Voltage	Voltage Input: Variable voltage input to control output swings.

### Absolute Maximum Ratings<sup>(1)</sup>

Supply Voltage ( $V_{CC}$ )	-0.5V to +6.0V
Input Voltage ( $V_{IN}$ )	-0.5V to $V_{CC}$
LVPECL Output Current ( $I_{OUT}$ )	
Continuous	50mA
Surge	100mA
Input Current	
Source or sink current on D, /D	±50mA
Current ( $V_{BB}$ )	
Source or sink current on $V_{BB}$ , <b>Note 3</b>	±1.5mA
Lead Temperature (soldering, 20 sec.)	+260°C
Storage Temperature ( $T_S$ )	-65°C to +150°C

### Operating Ratings<sup>(2)</sup>

Supply Voltage ( $ V_{CC}-V_{EE} $ )	3.0V to 3.6V
	4.5V to 5.5V
Ambient Temperature ( $T_A$ )	-40°C to +85°C
Package Thermal Resistance, ( <b>Note 4</b> )	
MLF™ ( $\theta_{JA}$ )	
Still-Air	93°C/W
500lfpm	87°C/W
MLF™ ( $\Psi_{JB}$ )	
Junction-to-Board	56°C/W

## PECL/ECL (100K) DC ELECTRICAL CHARACTERISTICS

$V_{CC} = +3.3V \pm 10\%$  or  $+5V \pm 10\%$  and  $V_{EE} = 0V$ ;  $V_{CC} = 0V$  and  $V_{EE} = -3.3V \pm 10\%$  or  $-5V \pm 10\%$ ;  $T_A = -40^\circ C$  to  $+85^\circ C$ ,  $R_L = 50\Omega$  to  $V_{CC} - 2V$  unless otherwise noted.

Symbol	Parameter	Condition	Min	Typ	Max	Units
$I_{EE}$	Power Supply Current	Max $V_{CC}$ , no load	—	—	51	mA
$V_{OH}$	Output HIGH Voltage		$V_{CC}-1.085$	—	$V_{CC}-0.88$	V
$V_{OL}$	Output LOW Voltage	$V_{CTRL} = V_{BB}$	$V_{CC}-1.90$	—	$V_{CC}-1.650$	V
	Output LOW Voltage	$V_{CTRL} = V_{CC}$	$V_{CC}-1.125$	—	$V_{CC}-0.975$	V
$V_{IH}$	Input HIGH Voltage		$V_{CC}-1.165$	—	$V_{CC}-0.88$	V
$V_{IL}$	Input LOW Voltage		$V_{CC}-1.810$	—	$V_{CC}-1.475$	V
$V_{BB}$	Bias Voltage		$V_{CC}-1.38$	—	$V_{CC}-1.26$	V
$I_{IH}$	Input HIGH Current	D, /D	—	—	150	μA
$I_{IL}$	Input LOW Current		0.5	—	—	μA
		$V_{CTRL} = V_{IH}$			80	μA

**Notes:**

1. Permanent device damage may occur if ABSOLUTE MAXIMUM RATINGS are exceeded. This is a stress rating only and functional operation is not implied at conditions other than those detailed in the operational sections of this data sheet. Exposure to ABSOLUTE MAXIMUM RATING conditions for extended periods may affect device reliability.
2. The data sheet limits are not guaranteed if the device is operated beyond the operating ratings.
3. Due to the limited drive capability use for input of the same package only.
4. Package thermal resistance assumes exposed pad is soldered (or equivalent) to the devices most negative potential on the PCB.

## AC ELECTRICAL CHARACTERISTICS

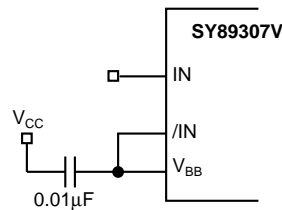
$V_{CC} = +3.3V \pm 10\%$  or  $+5V \pm 10\%$  and  $V_{EE} = 0V$ ;  $V_{CC} = 0V$  and  $V_{EE} = -3.3V \pm 10\%$  or  $-5V \pm 10\%$ ;  $T_A = -40^\circ C$  to  $+85^\circ C$ ,  $R_L = 50\Omega$  to  $V_{CC} - 2V$  unless otherwise noted.

Symbol	Parameter	Condition	Min	Typ	Max	Units
$f_{MAX}$	Maximum Throughput	NRZ Data	2.5	—	—	Gbps
$t_{pd}$	Propagation Delay	D (Diff) D (SE)	100 100	— 250	300 400	ps
$V_{PP}$	Minimum Input Swing	<b>Note 5</b>	150	—	—	mV
$V_{CMR}$	Common Mode Range	<b>Note 6</b>	$V_{CC} - 1.3$	—	$V_{CC} - 0.4$	V
$t_r, t_f$	Output Rise/Fall Times (20% to 80%)	Q, /Q; <b>Note 7</b>	—	95	160	ps

**Notes:**

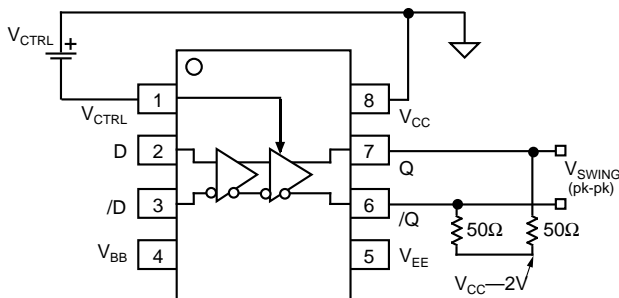
- Minimum input swing for which AC parameters are guaranteed. The device has a DC gain of  $\approx 40$  when output has a full swing.
- The CMR range is referenced to the most positive side of the differential input signal. Normal operation is obtained if the HIGH level falls within the specified range and the peak-to-peak voltage lies between  $V_{PP}(\text{min.})$  and 1V. The lower end of the CMR range varies 1:1 with  $V_{EE}$ . The numbers in the spec table assume a nominal  $V_{EE} = -3.3V$  and  $V_{CC} = 0V$ . Note for PECL operation, the  $V_{CMR}(\text{min.})$  will be fixed at  $3.3V - |V_{CMR}(\text{min.})|$ .
- Output at full swing.

## INPUT INTERFACE APPLICATIONS

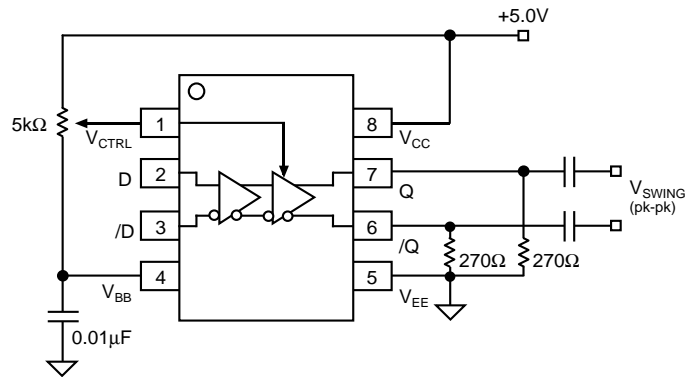


**Figure 1. Single-Ended Input (Terminating Unused Input)**

## APPLICATION IMPLEMENTATION

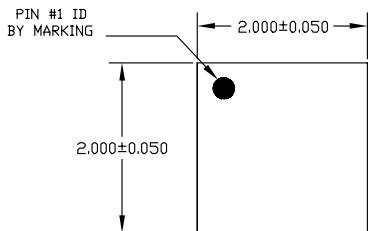


**Figure 2. Voltage Source Implementation**

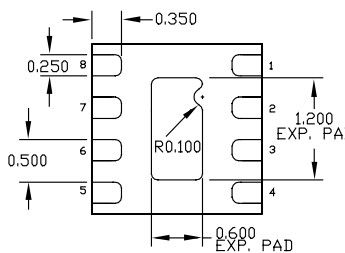


**Figure 3. Alternative Implementation**

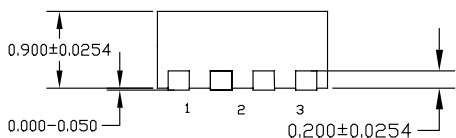
**8 LEAD ULTRA-SMALL EPAD-MicroLeadFrame® (MLF-8)**



TOP VIEW

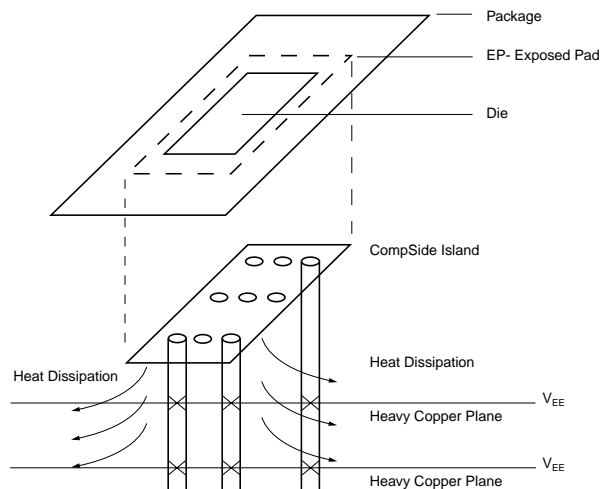


BOTTOM VIEW



SIDE VIEW

- NOTE:
1. ALL DIMENSIONS ARE IN MILLIMETERS.
  2. MAX. PACKAGE WARPAGE IS 0.05 mm.
  3. MAXIMUM ALLOWABLE BURRS IS 0.076 mm IN ALL DIRECTIONS.
  4. PIN #1 ID ON TOP WILL BE LASER/INK MARKED.



PCB Thermal Consideration for 8-Pin MLF® Package

**Package Notes:**

1. Package meets Level 2 qualification.
2. All parts are dry-packaged before shipment.
3. Exposed pads must be soldered to a plane equivalent to device  $V_{EE}$  for proper thermal management.

**MICREL, INC. 2180 FORTUNE DRIVE SAN JOSE, CA 95131 USA**

TEL + 1 (408) 944-0800 FAX + 1 (408) 474-1000 WEB <http://www.micrel.com>

The information furnished by Micrel in this datasheet is believed to be accurate and reliable. However, no responsibility is assumed by Micrel for its use. Micrel reserves the right to change circuitry and specifications at any time without notification to the customer.

Micrel Products are not designed or authorized for use as components in life support appliances, devices or systems where malfunction of a product can reasonably be expected to result in personal injury. Life support devices or systems are devices or systems that (a) are intended for surgical implant into the body or (b) support or sustain life, and whose failure to perform can be reasonably expected to result in a significant injury to the user. A Purchaser's use or sale of Micrel Products for use in life support appliances, devices or systems is at Purchaser's own risk and Purchaser agrees to fully indemnify Micrel for any damages resulting from such use or sale.

© 2006 Micrel, Incorporated.