

Optocoupler, Phototransistor Output, High Temperature

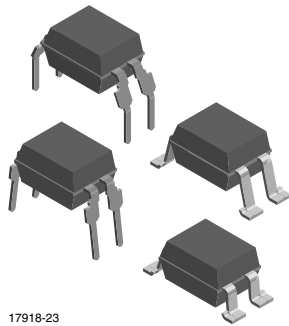

17918-23

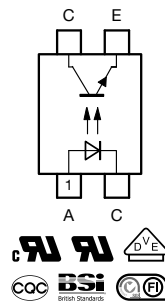

FEATURES

- Temperature range -55 °C to +110 °C
- Rated impulse voltage (transient overvoltage), $V_{IOTM} = 6 \text{ kV}_{\text{peak}}$
- Isolation test voltage (partial discharge test voltage), $V_{pd} = 1.6 \text{ kV}$
- Rated isolation voltage (RMS includes DC), $V_{IOWM} = 600 \text{ V}_{\text{RMS}}$
- Rated recurring peak voltage (repetitive) $V_{IORM} = 850 \text{ V}_{\text{peak}}$
- Material categorization: for definitions of compliance please see www.vishay.com/doc?99912

RoHS
COMPLIANT

DESCRIPTION

The VO615A consists of a phototransistor optically coupled to a gallium arsenide infrared-emitting diode in a 4 pin plastic dual in line package.

AGENCY APPROVALS

The safety application model number covering all products in this datasheet is VO615A. This model number should be used when consulting safety agency documents.

- BSI
- DIN EN 60747-5-5 (VDE 0884-5), available with option 1
- FIMKO
- UL 1577
- cUL 1577
- CQC

APPLICATIONS

Circuits for safe protective separation against electrical shock according to safety class II (reinforced isolation):

- Application class I to IV at mains voltage $\leq 300 \text{ V}$
- Application class I to IV at mains voltage $\leq 600 \text{ V}$ according to table 1 of IEC 60664-1, suitable for:
 - Switch-mode power supplies
 - Line receiver
 - Computer peripheral interface
 - Microprocessor system interface

ORDERING INFORMATION													
<div style="display: flex; justify-content: space-around; border-bottom: 1px solid black;"> VO615A </div> <p style="text-align: center;">PART NUMBER</p>						<div style="border: 1px solid black; padding: 2px; text-align: center;">#</div> <p style="text-align: center;">CTR BIN</p>	<div style="display: flex; justify-content: space-around; border-bottom: 1px solid black;"> X0## </div> <p style="text-align: center;">PACKAGE OPTION</p>				<div style="border: 1px solid black; padding: 2px; text-align: center;">T</div> <p style="text-align: center;">TAPE AND REEL</p>		
AGENCY CERTIFIED/ PACKAGE	CTR (%)												
	5 mA	10 mA				5 mA							
UL, cUL, BSI, FIMKO, CQC	50 to 600	40 to 80	63 to 125	100 to 200	160 to 320	50 to 150	100 to 300	80 to 160	130 to 260	200 to 400			
DIP-4	VO615A	VO615A-1	VO615A-2	VO615A-3	VO615A-4	VO615A-5	VO615A-6	VO615A-7	VO615A-8	VO615A-9			
DIP-4, 400 mil, option 6	VO615A-X006	VO615A-1X006	VO615A-2X006	VO615A-3X006	VO615A-4X006	VO615A-5X006	VO615A-6X006	VO615A-7X006	VO615A-8X006	VO615A-9X006			
SMD-4, option 7	VO615A-X007T	VO615A-1X007T	VO615A-2X007T	VO615A-3X007T	VO615A-4X007T	VO615A-5X007T	VO615A-6X007T	VO615A-7X007T	VO615A-8X007T	VO615A-9X007T			
SMD-4, option 8	-	-	-	VO615A-3X008T	-	-	-	-	-	-			
SMD-4, option 9	VO615A-X009T	VO615A-1X009T	VO615A-2X009T	VO615A-3X009T	VO615A-4X009T	VO615A-5X009T	VO615A-6X009T	VO615A-7X009T	-	VO615A-9X009T			
UL, cUL, BSI, FIMKO, CQC, VDE (option 1)	50 to 600	40 to 80	63 to 125	100 to 200	160 to 320	50 to 150	100 to 300	80 to 160	130 to 260	200 to 400			
DIP-4	VO615A-X001	VO615A-1X001	VO615A-2X001	VO615A-3X001	VO615A-4X001	-	VO615A-6X001	VO615A-7X001	VO615A-8X001	-			
DIP-4, 400 mil, option 6	-	-	VO615A-2X016	VO615A-3X016	VO615A-4X016	VO615A-5X016	-	-	VO615A-8X016	VO615A-9X016			
SMD-4, option 7	VO615A-X017T	VO615A-1X017T	-	VO615A-3X017T	VO615A-4X017T	-	VO615A-6X017T	VO615A-7X017T	VO615A-8X017T	VO615A-9X017T			
SMD-4, option 8	-	-	-	VO615A-3X018T	VO615A-4X018T	-	-	-	VO615A-8X018T	-			
SMD-4, option 9	-	VO615A-1X019T	VO615A-2X019T	VO615A-3X019T	VO615A-4X019T	-	-	-	-	-			

Note

- Additional options may be possible, please contact sales office

ABSOLUTE MAXIMUM RATINGS ($T_{amb} = 25\text{ }^{\circ}\text{C}$, unless otherwise specified)				
PARAMETER	TEST CONDITION	SYMBOL	VALUE	UNIT
INPUT				
Reverse voltage		V_R	6	V
Forward current		I_F	60	mA
Forward surge current	$t_p \leq 10\text{ }\mu\text{s}$	I_{FSM}	1.5	A
LED power dissipation	at $25\text{ }^{\circ}\text{C}$	P_{diss}	100	mW
OUTPUT				
Collector emitter voltage		V_{CEO}	70	V
Emitter collector voltage		V_{ECO}	7	V
Collector current		I_C	50	mA
Collector peak current	$t_p/T = 0.5, t_p \leq 10\text{ ms}$	I_{CM}	100	mA
Output power dissipation	at $25\text{ }^{\circ}\text{C}$	P_{diss}	150	mW
COUPLER				
Operating ambient temperature range		T_{amb}	-55 to +110	$^{\circ}\text{C}$
Storage temperature range		T_{stg}	-55 to +125	$^{\circ}\text{C}$
Soldering temperature ⁽¹⁾	2 mm from case, $\leq 10\text{ s}$	T_{sld}	260	$^{\circ}\text{C}$

Notes

- Stresses in excess of the absolute maximum ratings can cause permanent damage to the device. Functional operation of the device is not implied at these or any other conditions in excess of those given in the operational sections of this document. Exposure to absolute maximum ratings for extended periods of the time can adversely affect reliability
- Refer to reflow profile for soldering conditions for surface mounted devices (SMD), and wave profile for soldering conditions for through hole devices (DIP), please go to "Assembly Instructions" (www.vishay.com/doc?80054)

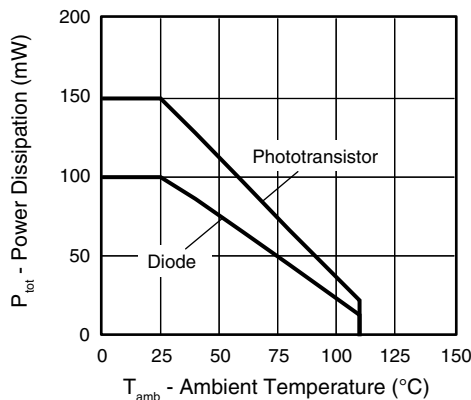

Fig. 1 - Permissible Power Dissipation vs. Ambient Temperature

ELECTRICAL CHARACTERISTICS ($T_{amb} = 25\text{ }^{\circ}\text{C}$, unless otherwise specified)						
PARAMETER	TEST CONDITION	SYMBOL	MIN.	TYP.	MAX.	UNIT
INPUT						
Forward voltage	$I_F = 50\text{ mA}$	V_F	-	1.43	1.6	V
Reverse current	$V_R = 6\text{ V}$	I_R	-	-	100	μA
Junction capacitance	$V_R = 0, f = 1\text{ MHz}$	C_j	-	50	-	pF
OUTPUT						
Collector emitter voltage	$I_C = 1\text{ mA}$	V_{CEO}	70	-	-	V
Emitter collector voltage	$I_E = 100\text{ }\mu\text{A}$	V_{ECO}	7	-	-	V
Collector emitter leakage current	$V_{CE} = 20\text{ V}, I_F = 0$	I_{CEO}	-	10	100	nA
COUPLER						
Collector emitter saturation voltage	$I_F = 10\text{ mA}, I_C = 1\text{ mA}$	V_{CEsat}	-	-	0.3	V
Cut-off frequency	$V_{CE} = 5\text{ V}, I_F = 10\text{ mA}, R_L = 100\text{ }\Omega$	f_c	-	110	-	kHz
Coupling capacitance	$f = 1\text{ MHz}$	C_k	-	0.6	-	pF

Note

- Minimum and maximum values are testing requirements. Typical values are characteristics of the device and are the result of engineering evaluation. Typical values are for information only and are not part of the testing requirements



CURRENT TRANSFER RATIO ($T_{amb} = 25\text{ }^{\circ}\text{C}$, unless otherwise specified)							
PARAMETER	TEST CONDITION	PART	SYMBOL	MIN.	TYP.	MAX.	UNIT
I_C/I_F	$V_{CE} = 5\text{ V}, I_F = 1\text{ mA}$	VO615A-1	CTR	13	30	-	%
		VO615A-2	CTR	22	45	-	%
		VO615A-3	CTR	34	70	-	%
		VO615A-4	CTR	56	90	-	%
	$V_{CE} = 5\text{ V}, I_F = 5\text{ mA}$	VO615A	CTR	50	-	600	%
		VO615A-5	CTR	50	-	150	%
		VO615A-6	CTR	100	-	300	%
		VO615A-7	CTR	80	-	160	%
		VO615A-8	CTR	130	-	260	%
	$V_{CE} = 5\text{ V}, I_F = 10\text{ mA}$	VO615A-9	CTR	200	-	400	%
		VO615A-1	CTR	40	-	80	%
		VO615A-2	CTR	63	-	125	%
		VO615A-3	CTR	100	-	200	%
		VO615A-4	CTR	160	-	320	%

SAFETY AND INSULATION RATED PARAMETERS				
PARAMETER	TEST CONDITION	SYMBOL	VALUE	UNIT
Climatic classification	According to IEC 68 part 1		55 / 110 / 21	
Pollution degree	According to DIN VDE 0109		2	
Comparative tracking index	Insulation group IIIa	CTI	250	
Maximum rated withstanding isolation voltage	According to UL1577, $t = 1\text{ min}$	V_{ISO}	5000	V_{AC}
Maximum transient isolation voltage	According to DIN EN 60747-5-5	V_{IOTM}	6000	V_{peak}
Maximum repetitive peak isolation voltage	According to DIN EN 60747-5-5	V_{IORM}	850	V_{peak}
Isolation resistance	$T_{amb} = 25\text{ }^{\circ}\text{C}, V_{IO} = 500\text{ V}$	R_{IO}	$\geq 10^{12}$	Ω
	$T_{amb} = 100\text{ }^{\circ}\text{C}, V_{IO} = 500\text{ V}$	R_{IO}	$\geq 10^{11}$	Ω
	$T_{amb} = T_S, V_{IO} = 500\text{ V}$	R_{IO}	$\geq 10^9$	Ω
Output safety power		P_{SO}	265	mW
Input safety current		I_{SI}	130	mA
Input safety temperature		T_S	150	$^{\circ}\text{C}$
Creepage distance	DIP-4; SMD-4, option 7; SMD-4, option 9		≥ 7.6	mm
Clearance distance			≥ 7.6	mm
Creepage distance	DIP-4, 400 mil, option 6; SMD-4, option 8		≥ 8.0	mm
Clearance distance			≥ 8.0	mm
Insulation thickness		DTI	≥ 0.4	mm
Input to output test voltage, method B	$V_{IORM} \times 1.875 = V_{PR}$, 100 % production test with $t_M = 1\text{ s}$, partial discharge $< 5\text{ pC}$	V_{PR}	1600	V_{peak}
Input to output test voltage, method A	$V_{IORM} \times 1.6 = V_{PR}$, 100 % sample test with $t_M = 10\text{ s}$, partial discharge $< 5\text{ pC}$	V_{PR}	1360	V_{peak}

Note

- According to DIN EN 60747-5-5 (VDE 0884), § 7.4.3.8.2 (see Fig. 2). This optocoupler is suitable for safe electrical isolation only within the safety ratings. Compliance with the safety ratings shall be ensured by means of suitable protective circuits

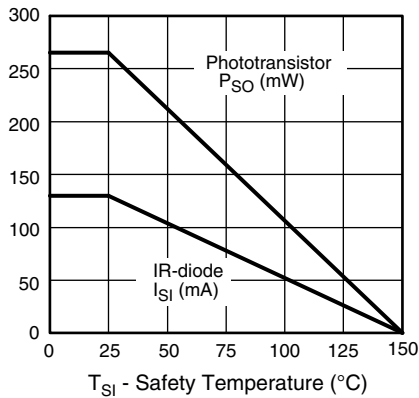

Fig. 2 - Derating Diagram

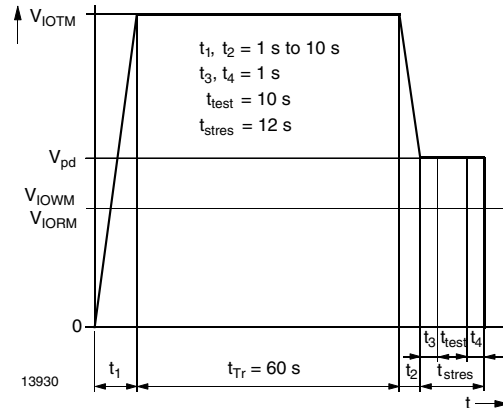

Fig. 3 - Test Pulse Diagram for Sample Test According to DIN EN 60747-5-2 (VDE 0884); IEC 60747-5-5

SWITCHING CHARACTERISTICS ($T_{amb} = 25 \text{ }^\circ\text{C}$, unless otherwise specified)						
PARAMETER	TEST CONDITION	SYMBOL	MIN.	TYP.	MAX.	UNIT
Delay time	$V_S = 5 \text{ V}$, $I_C = 2 \text{ mA}$, $R_L = 100 \text{ } \Omega$	t_d	-	3	-	μs
Rise time	$V_S = 5 \text{ V}$, $I_C = 2 \text{ mA}$, $R_L = 100 \text{ } \Omega$	t_r	-	3	-	μs
Fall time	$V_S = 5 \text{ V}$, $I_C = 2 \text{ mA}$, $R_L = 100 \text{ } \Omega$	t_f	-	4.7	-	μs
Storage time	$V_S = 5 \text{ V}$, $I_C = 2 \text{ mA}$, $R_L = 100 \text{ } \Omega$	t_s	-	0.3	-	μs
Turn-on time	$V_S = 5 \text{ V}$, $I_C = 2 \text{ mA}$, $R_L = 100 \text{ } \Omega$	t_{on}	-	6	-	μs
Turn-off time	$V_S = 5 \text{ V}$, $I_C = 2 \text{ mA}$, $R_L = 100 \text{ } \Omega$	t_{off}	-	5	-	μs
Turn-on time	$V_S = 5 \text{ V}$, $I_F = 10 \text{ mA}$, $R_L = 1 \text{ k}\Omega$	t_{on}	-	3	-	μs
Turn-off time	$V_S = 5 \text{ V}$, $I_F = 10 \text{ mA}$, $R_L = 1 \text{ k}\Omega$	t_{off}	-	10	-	μs

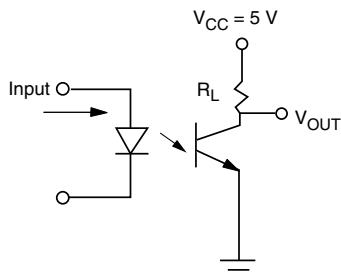

Fig. 4 - Test Circuit

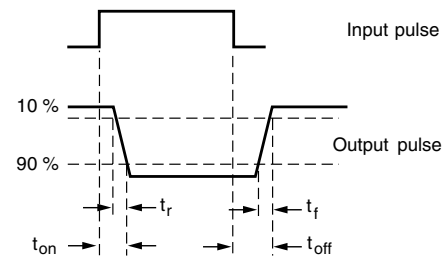

Fig. 5 - Test Circuit and Waveforms

TYPICAL CHARACTERISTICS ($T_{amb} = 25\text{ }^{\circ}\text{C}$, unless otherwise specified)

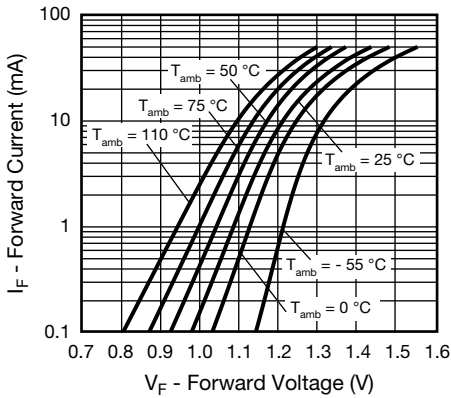

Fig. 6 - Forward Current vs. Forward Voltage

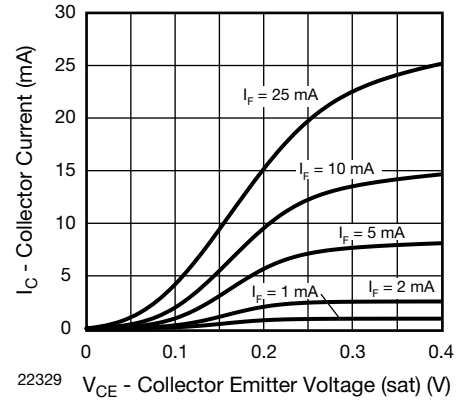

Fig. 9 - Collector Current vs. Collector Emitter Voltage (saturated)

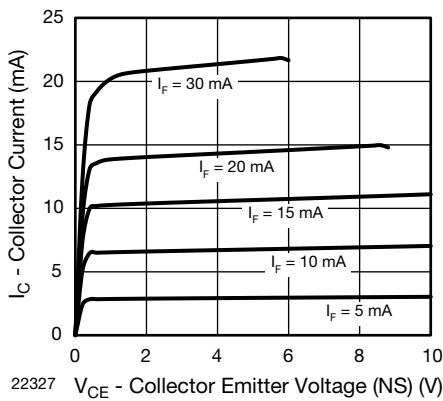

Fig. 7 - Collector Current vs. Collector Emitter Voltage (non-saturated)

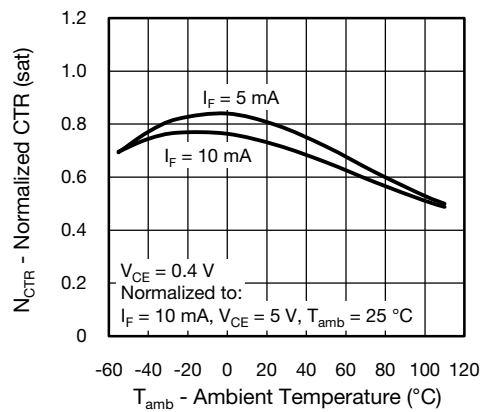

Fig. 10 - Normalized CTR (saturated) vs. Ambient Temperature

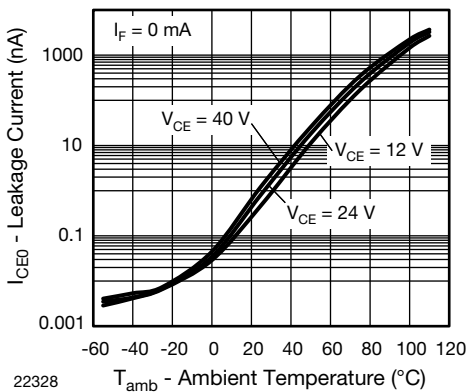

Fig. 8 - Leakage Current vs. Ambient Temperature

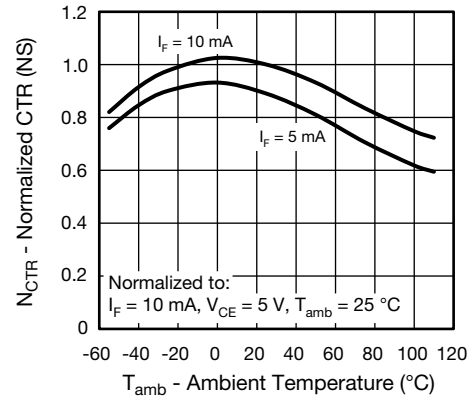

Fig. 11 - Normalized CTR (non-saturated) vs. Ambient Temperature

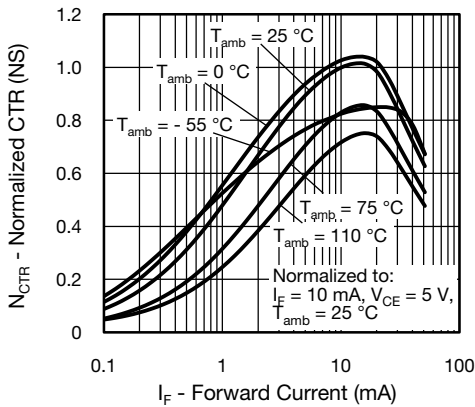

Fig. 12 - Normalized CTR (non-saturated) vs. Forward Current

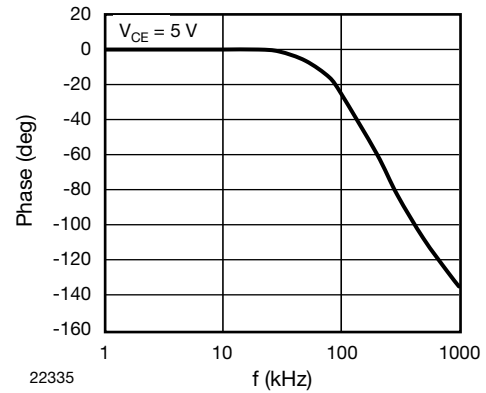

Fig. 15 - Phase Angle vs. Frequency

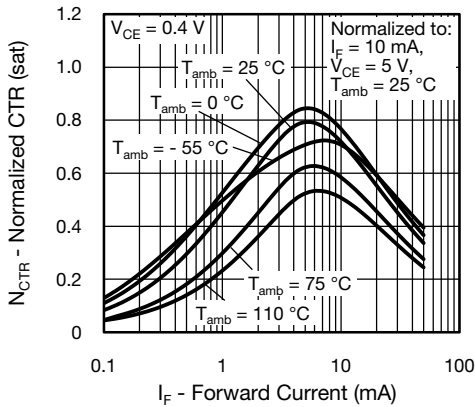

Fig. 13 - Normalized CTR (saturated) vs. Forward Current

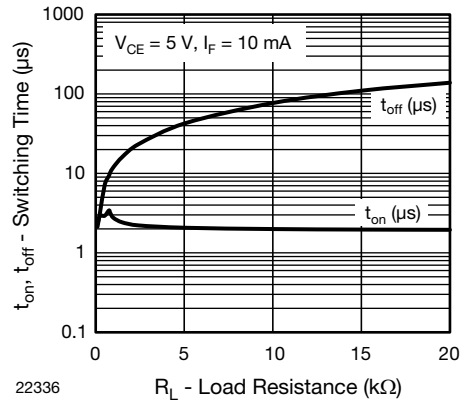

Fig. 16 - Switching Time vs. Load Resistance

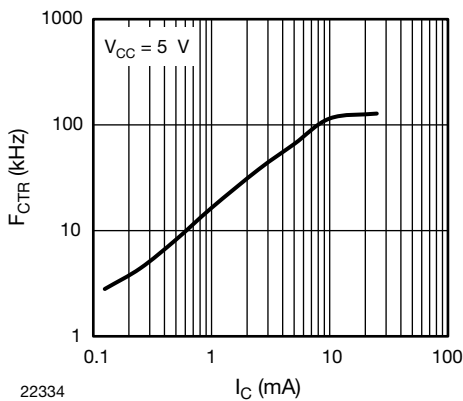
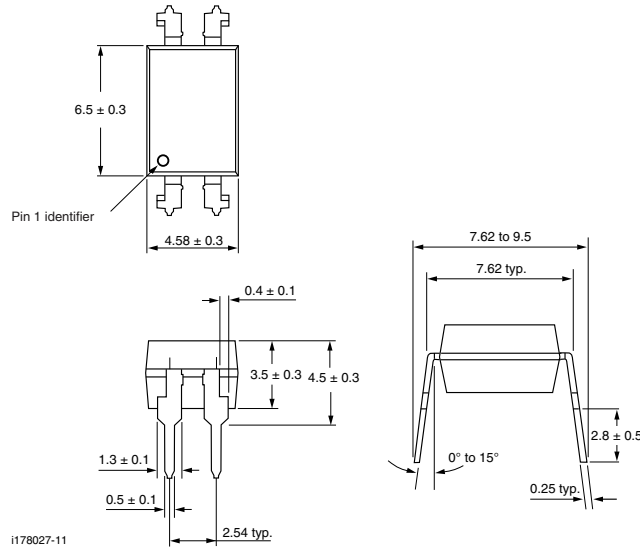
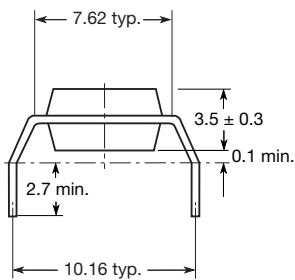

Fig. 14 - F_{CTR} vs. I_C (saturated) (mA)

PACKAGE DIMENSIONS (in millimeters)



Option 6



Option 7

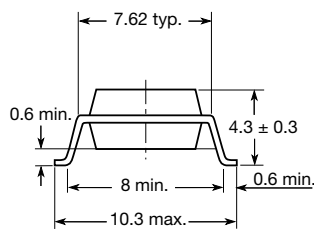

Option 8

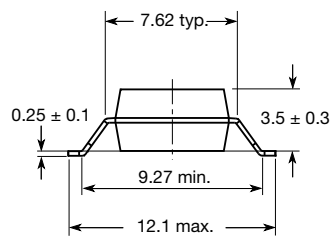

Option 9

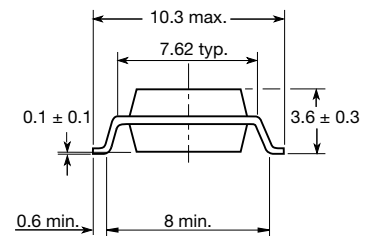

20802-36

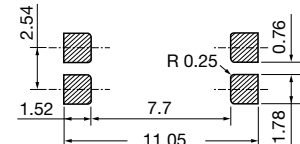
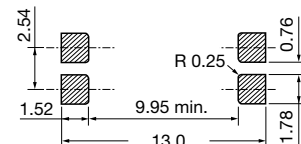
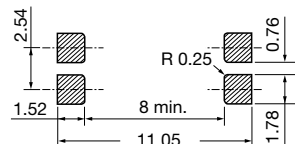

PACKAGE MARKING (example of VO615A-3X017T)

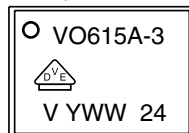

Notes

- Only options 1, 7, and 8 are reflected in the package marking
- The VDE logo is only marked on option1 parts
- Tape and reel suffix (T) is not part of the package marking

PACKING INFORMATION (in millimeters)

TUBE PACKING			
TYPE	UNITS/TUBE	TUBES/BOX	UNITS/BOX
DIP-4, standard and option 6	100	40	4000

TAPE AND REEL PACKING	
TYPE	UNITS/TUBE
SMD-4, option 7 and option 9	1000
SMD-4, option 8	2000

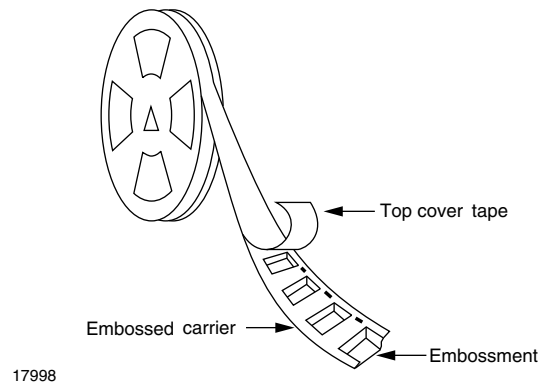

17998

Fig. 17 - Tape and Reel Shipping Medium

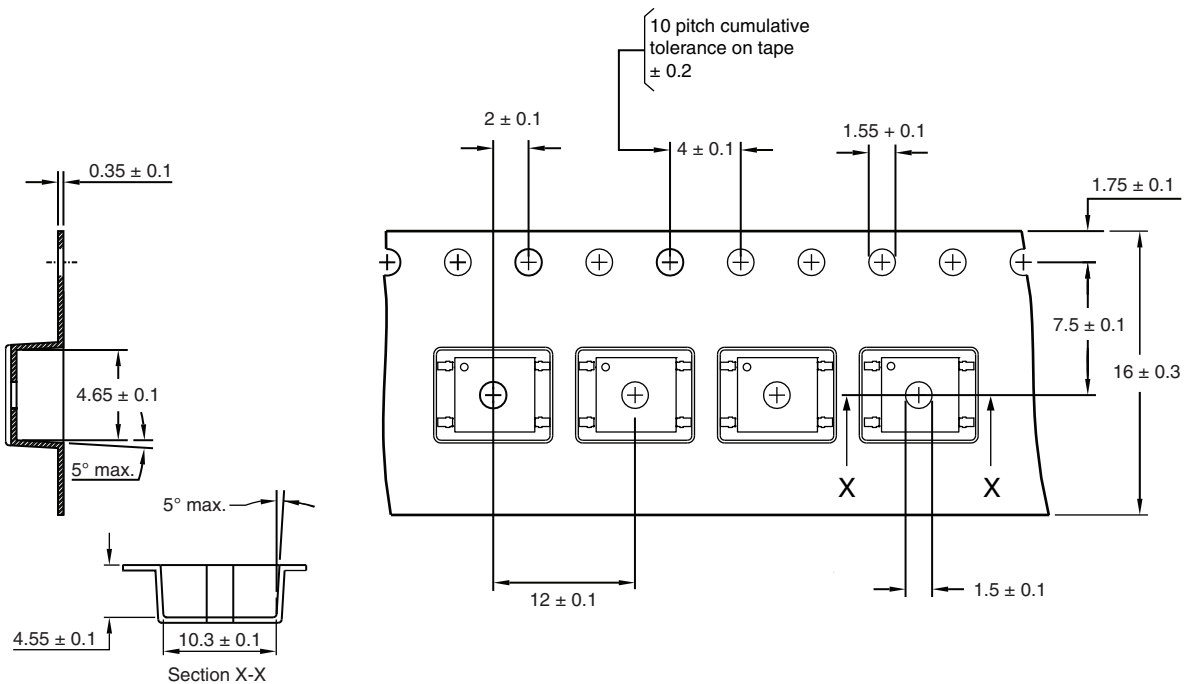
 Fig. 18 - Tape and Reel Packing for Option 7 and Option 9
(1000 units per reel)

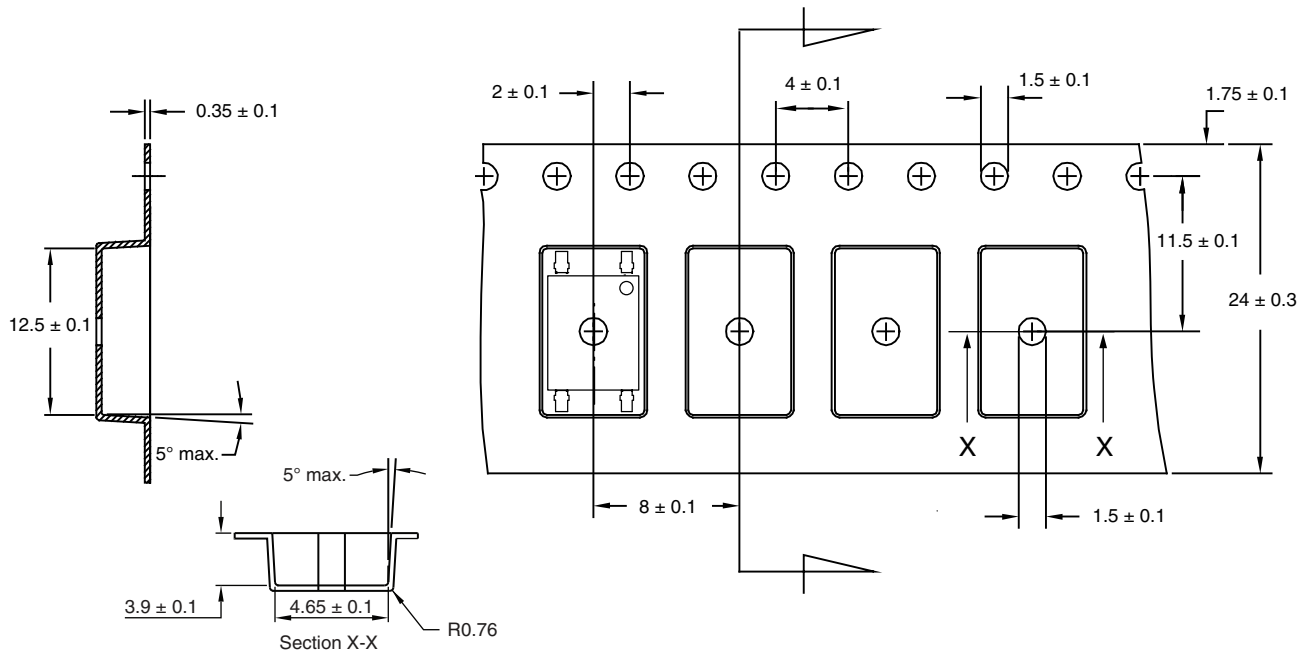

Fig. 19 - Tape and Reel Packing for Option 8
(2000 units per reel)



Disclaimer

ALL PRODUCT, PRODUCT SPECIFICATIONS AND DATA ARE SUBJECT TO CHANGE WITHOUT NOTICE TO IMPROVE RELIABILITY, FUNCTION OR DESIGN OR OTHERWISE.

Vishay Intertechnology, Inc., its affiliates, agents, and employees, and all persons acting on its or their behalf (collectively, "Vishay"), disclaim any and all liability for any errors, inaccuracies or incompleteness contained in any datasheet or in any other disclosure relating to any product.

Vishay makes no warranty, representation or guarantee regarding the suitability of the products for any particular purpose or the continuing production of any product. To the maximum extent permitted by applicable law, Vishay disclaims (i) any and all liability arising out of the application or use of any product, (ii) any and all liability, including without limitation special, consequential or incidental damages, and (iii) any and all implied warranties, including warranties of fitness for particular purpose, non-infringement and merchantability.

Statements regarding the suitability of products for certain types of applications are based on Vishay's knowledge of typical requirements that are often placed on Vishay products in generic applications. Such statements are not binding statements about the suitability of products for a particular application. It is the customer's responsibility to validate that a particular product with the properties described in the product specification is suitable for use in a particular application. Parameters provided in datasheets and / or specifications may vary in different applications and performance may vary over time. All operating parameters, including typical parameters, must be validated for each customer application by the customer's technical experts. Product specifications do not expand or otherwise modify Vishay's terms and conditions of purchase, including but not limited to the warranty expressed therein.

Except as expressly indicated in writing, Vishay products are not designed for use in medical, life-saving, or life-sustaining applications or for any other application in which the failure of the Vishay product could result in personal injury or death. Customers using or selling Vishay products not expressly indicated for use in such applications do so at their own risk. Please contact authorized Vishay personnel to obtain written terms and conditions regarding products designed for such applications.

No license, express or implied, by estoppel or otherwise, to any intellectual property rights is granted by this document or by any conduct of Vishay. Product names and markings noted herein may be trademarks of their respective owners.